



ENVIRONMENTAL IMPACT ASSESSMENT REPORT

for obtaining the

ENVIRONMENTAL AGREEMENT

Objective:

"Construction works for the Heavy Water Tritium Removal Facility" proposed to be located on the NPP Platform, Cernavoda city, Constanța county

NUCLEARELECTRICA S.A. National Society, through the Cernavoda NPP Branch





MINISTRY OF RESEARCH, INNOVATION AND DIGITIZATION
„DANUBE DELTA” NATIONAL INSTITUTE
FOR RESEARCH AND DEVELOPMENT – TULCEA

165 Babadag Street RO 820112 Tulcea, Romania phone +4 0240 531520 fax +4 0240 533547 E-mail office@ddni.ro web http://www.ddni.ro

ENVIRONMENTAL IMPACT ASSESSMENT REPORT
for getting
ENVIRONMENTAL AGREEMENT









Objective:

“Construction works for the Heavy Water Tritium Removal Facility”, proposed to be located on the Platform NPP, Cernavoda city, Constanta County, NUCLEARELECTRICA National Company, through Cernavoda NPP Branch

General Director: Dr. biol. Marian TUDOR

Expert coordinator: CS III Anca CRĂCIUN

Elaboration team:

Anca CRĂCIUN		Scientific researcher III	Environmental impact assessment Expert, DDNI Tulcea
Adrian BURADA		Dr. Scientific researcher III	Air quality assessment/ non-radioactive physico-chemical indicators Expert, DDNI Tulcea
Marian TUDOR		Dr. Scientific researcher I	Risk Expert, DDNI Tulcea
Alexandru DOROȘENCU		Dr. Scientific researcher III	Biodiversity Expert, INCDDO Tulcea
Orhan IBRAM		Scientific researcher III	Biodiversity Expert, DDNI Tulcea
Marian MIERLĂ		Dr. Scientific researcher III	Climate change / GIS Expert, DDNI Tulcea
Cristina DESPINA		Dr. Scientific researcher II	Non-radioactive waste/ wastewater Expert, DDNI Tulcea
Mihaela-Iuliana TUDOR		Dr. Scientific researcher I	Evaluation of water quality/ non-radioactive physico-chemical indicators Expert, DDNI Tulcea
Romulus-Dumitru COSTACHE		Dr. Scientific researcher	GIS Expert, DDNI Tulcea
Daniela SECELEANU ODOR		Scientific researcher	Laboratory analysis non-radioactive physico-chemical indicators, DDNI Tulcea
Mihaela ȚIGĂNUȘ		Chemistry Laboratory Technician	Laboratory analysis non-radioactive physico-chemical indicators, DDNI Tulcea
Alexandru TOMA		Dr. eng. Scientific researcher III	Expert III CNCAN radiological protection / Responsible for assessing the radiological impact on the environment and the population, RATEN ICN Pitești
Cristian Nicolae DULAMA		Dr. eng. Scientific researcher III	Expert III CNCAN radiological protection / Responsible for assessing the radiological impact on the environment and the population, RATEN ICN Pitești
Bogdan LAZAROVICI		Engineer	Noise and vibration Expert Enviro Consult SRL Bucharest

February 2022



Table of Contents

List of figures	7
List of tables	10
List of abbreviations.....	14
GENERAL INFORMATION	17
1. PROJECT DESCRIPTION	22
1.1 Project location	22
1.1.1 General description of the site.....	22
1.1.2 Land use regime in the site area	22
1.1.3 Distance to the Borders of Bulgaria, Ukraine and the Republic of Moldova	23
1.1.4. Objectives located in the vicinity of the site.....	23
1.1.5 The distances between the location of the works and the objectives of interest	24
1.2 The physical characteristics of the whole project.....	25
1.2.1 The need for the project	25
1.2.2 The program for the implementation of the project	26
1.2.2.1 The main stages of the project	26
1.2.2.2 Estimated duration.....	26
1.2.2.3 Description of main components of the project, including associated / auxiliary works and facilities for public safety and environmental protection	27
1.2.3 Structural components	31
1.2.3.1 Construction details	31
1.2.3.2 Construction methods adopted	32
1.2.3.3 Permanently and temporarily occupied land area	33
1.2.3.4 Land areas occupied by each of the permanent components of the project	33
1.2.4 Emissions	34
1.2.5 Types and quantities of chemicals used	34
1.2.6 Generated waste and wastes management.....	35
1.2.7 Natural resources, raw materials and energy required to carry out the project	37
1.2.8 Tools, equipment and other means necessary to be used	37
1.2.9 Route, horizontal and vertical alignments, excavations and earthworks	38
1.2.10 Demolishing activities required for project implementation	39
1.2.11 Installations / Constructions required for the project	39
1.2.12 Further developments that may occur as a result of the project	40
1.2.13 Existing activities that will be modified or changed as a consequence of the project.....	40
1.2.14 Relationship with other existing or future projects	40
1.2.15 Associated / auxiliary works that are excluded from the evaluation.....	42
1.2.16 Restoration work on the site in the area affected by the execution of the investment	42
1.2.17 The size of any structures and other development works as part of the project.....	42
1.2.18 Stage of technological tests and commissioning	42
1.3 Main features of the operation stage of the project.....	43
1.3.1 Description of the plant and technological flows	43
1.3.2 Raw materials, energy and fuels used, and how to procure them	52
1.3.3 Type and quantity of finished products resulting from the project.....	53
1.3.4 Facilities for the retention, evacuation and dispersion of pollutants in the environment.....	53
1.3.5 Utilities required for the operation of the CTRF.....	56
1.3.6 Hazardous materials used, stored, handled or produced during the project operation	58
1.3.7 Transport of raw and auxiliary materials and increased traffic involved during operation	59
1.3.8 Environmentally relevant social and socio-economic implications.....	60
1.3.9 Possible future changes to the project	61
1.4 Estimation, by type and quantity, of the expected waste and emissions	61
1.4.1 Waste and emissions expected to be generated during the technological testing / commissioning test period	61
1.4.2 Types, codes and quantities / volumes of waste generated by the project during the construction phase.....	62
1.4.3 Types, codes and quantities / volumes of waste generated by the project during operation	64
1.4.5 Waste management program (collection, storage, treatment / recovery, transport and final storage / disposal) in the project stages: construction / installation, operation, decommissioning; radioactive waste generated and how it is managed	67
1.4.5.1 Construction stage.....	67
1.4.5.2 Operating stage	67

1.4.5.3 Decommissioning stage	71
1.4.6 Types and quantities of liquid effluents generated by the project (including effluents, technological waste, cooling water, sewage, treated wastewater, as appropriate), during construction, operation, decommissioning and their management	71
1.4.6.1 Construction stage.....	71
1.4.6.2 Operating stage	72
1.4.6.3 Decommissioning stage	72
1.4.7 Composition and toxicity or hazardousness of all liquid effluents produced by the project	73
1.4.8 Liquid effluent management and monitoring program; including the calculation of radionuclide dispersion in surface waters.....	73
1.4.9 Types and quantities / volumes of gaseous and dust emissions generated by the project (process emissions, radioactive emissions, spontaneous emissions, emissions from burning fossil fuels from stationary sources – Stand-by Diesel generator groups, dust from handled materials, odors), during construction and operation.....	76
1.4.9.1 Construction period	76
1.4.9.2 Operating period.....	77
1.4.10 Methods of collection, treatment and disposal of emissions	79
1.4.11 Gaseous effluent management and monitoring program.....	80
1.4.12 Characteristics of atmospheric emission sources, as well as their characteristics (stack height, emission velocity and temperature, etc.).....	81
1.4.13 Dispersion factors for gas from the Stand-by Diesel generator groups	82
1.4.14 Dispersion factors for radionuclides released into the atmosphere	85
1.4.15 Noise sources from the project.....	89
1.4.17 Methods for estimating the quantities and composition of all identified wastes and emissions and the uncertainty associated with these estimates	90
2. DESCRIPTION OF FEASIBLE ALTERNATIVES	91
2.1 Identifying alternatives.....	92
2.1.1 "Zero" Alternative.....	92
2.1.2 Alternative 1: Detritiation at the CANDU nuclear power plant site (on-site).....	92
2.1.2.1 Technological options for the Cernavoda NPP tritium removal facility (CTRF)	94
2.1.2.2 Layout / areas options on the site of the nuclear power plant.....	95
2.1.3 Alternative 2: Tritium removal in other off-site facilities.....	100
3. DESCRIPTION OF THE RELEVANT ASPECTS OF THE CURRENT STATE OF THE ENVIRONMENT	103
3.1 The water environment factor.....	104
3.1.1 Surface waters.....	104
3.1.2 Groundwater.....	107
3.1.3 Water quality and use.....	108
3.1.3.1 Radiological characterization of the water environment factor	108
3.1.3.2 Water use	114
3.1.4 Liquid effluent evacuation point.....	115
3.1.5 Water sources that may be affected by the project.....	119
3.2 The air environment factor.....	119
3.3 Soil / subsoil environmental factor.....	129
3.3.1 Topography	129
3.3.2 Geology	130
3.3.3 Soil.....	132
3.3.4 Land condition and use	132
3.4 Biodiversity	134
3.5 Climate and climate change	169
3.6 Radioactivity	182
3.7 Noise.....	190
3.8 Population.....	194
3.9 Tangible assets	200
3.9.1 Archaeological sites	201
3.9.2 Historical monuments	204
4. DESCRIPTION OF THE ENVIRONMENTAL FACTORS LIKELY TO BE AFFECTED BY THE PROJECT	206
4.1 The environmental factor water	206
4.1.1 Qualitative radioactivity analysis for surface waters.....	206
4.1.2 Qualitative physico-chemical analysis for surface waters	207
4.1.3 Qualitative analysis from the point of view of radioactivity for drinking water	209

4.1.4 Qualitative radioactivity analysis for deep groundwater	210
4.1.5 Qualitative radioactivity analysis for wet atmospheric depositions	210
4.2 Air environmental factor.....	212
4.2.1 Qualitative analysis from the point of view of radioactivity for the air environment factor	212
4.2.2 Physico-chemical qualitative analysis for the air environment factor.....	215
4.3 Soil environmental factor	215
4.3.1 Qualitative analysis from the point of view of radioactivity for the soil environmental factor	215
4.3.2 Qualitative analysis from a physical - chemical point of view for the soil environmental factor	217
4.4 Biodiversity	217
4.4.1 Qualitative radioactivity analysis for biodiversity	217
4.5 Climate and climate change	221
4.5.1 Predicted risks of heat waves.....	222
4.5.2 Predicted risks of drought.....	225
4.5.3 Predicted risks of extreme precipitations	226
4.5.4 Predicted risks for floods caused by rivers.....	229
4.5.5 Predicted risks of strong storms and winds.....	229
4.5.6 Predicted risks for landslides.....	232
4.5.7 Forecasted risks for rising sea levels, storm surges	232
4.5.8 Predicted risks for cold periods	232
4.5.9 Damage caused by freeze-thaw phenomenon	234
4.6 Population.....	234
4.6.1 Administrative and geographical location.....	234
4.6.2 Existing and future residential localities / areas and distances from location to residential or commercial areas	234
4.6.3 Occupations and activities of the inhabitants of the area.....	235
4.7.1 Population exposure to CTRF activity.....	237
4.7.2 Presentation and validation of up-to-date data used for public dose assessment.....	241
4.7.3 Validation of the results of analysis and public dose calculations.....	245
4.8 Radioactivity	247
4.9 Material goods	248
4.10 Conclusions of the Security Analysis and Reports.....	249
5. DESCRIPTION OF THE SIGNIFICANT EFFECTS THAT THE PROJECT MAY HAVE ON THE ENVIRONMENT.....	249
5.1 Potential impact from the use of natural resources in the context of sustainable development	250
5.2 Assessment of potential impacts on environmental factors	250
5.2.1 Environmental factor water.....	250
5.2.2 Environmental factor air	251
5.2.3 Environmental factor soil	258
5.2.4 Biodiversity	259
5.2.5 Climate and climate change	259
5.2.6 Noise	261
5.2.7 Socio-economic.....	265
5.2.8 Human health	265
5.2.9 Material goods.....	267
5.3 Cumulating effects with those of other existing and / or approved projects taking into account any existing environmental issues related to areas of particular environmental importance that could be affected, or the use of natural resources.....	267
5.4 Projects / activities planned to be built / put into operation in parallel with the CTRF, whose areas of influence overlap in whole or in part with that of the project assessed during both construction and operation.....	268
5.5 Effects which may arise from accidents, unusual events or exposure of the project to natural or man-made disasters (including in a transboundary context).....	269
5.6 Cross-border nature - impact on neighboring states: Bulgaria, Ukraine and the Republic of Moldova	272
6. DESCRIPTION OF FORECASTING METHODS USED TO IDENTIFY AND ASSESS SIGNIFICANT EFFECTS ON THE ENVIRONMENT, INCLUDING DETAILS OF DIFFICULTIES ENCOUNTERED	273
6.1 Emission estimation methodologies	273
6.1.1 Estimation of radioactive emissions	273
6.1.2 Estimation of non-radioactive emissions.....	273
6.2 Methodologies for modeling pollutant dispersion	274
6.2.1 Dispersion of radioactive pollutants	274

6.2.2 Dispersion of non-radioactive pollutants	274
6.2.3 Noise assessment method	275
6.3 Uncertainty about the precise details of the project and its impact on the environment.....	275
6.4 Difficulties in processing the data needed to predict and evaluate the effects	276
6.5 Basis for assessing the significance and significance of the impact.....	276
7. DESCRIPTION OF THE TARGETED MEASURES FORESEEN TO AVOID, PREVENT, REDUCE OR WHERE POSSIBLE OFFSET ANY IDENTIFIED SIGNIFICANT ADVERSE ENVIRONMENTAL EFFECTS AND A DESCRIPTION OF ANY PROPOSED MONITORING MEASURES	277
7.1 Measures taken into account since the choice of alternatives	277
7.2 Actions to avoid, prevent, reduce or, if possible, offset any significant adverse effects identified on the environment considered at all stages of construction, operation and decommissioning	277
7.3 Climate change adaptation measures.....	279
7.4 Residual impact, remaining after all mitigation measures have been taken	280
7.5 Measures both in terms of radiological impact and in terms of non-radiological impact.....	280
7.6 Monitoring actions for environmental factors for which a significant adverse effect has been identified	280
8. DESCRIPTION OF THE POSSIBLE SIGNIFICANT ADVERSE EFFECTS OF THE PROJECT ON THE ENVIRONMENT AS A RESULT OF THE PROJECT'S VULNERABILITY TO THE RISKS OF MAJOR ACCIDENTS AND / OR DISASTERS RELEVANT TO THE PROJECT IN QUESTION	281
8.1 Assessing the risks associated with activities that present major-accident hazards involving hazardous substances.....	282
8.2 Nuclear safety analysis **	284
8.2.1 Nuclear safety analysis for anticipated operational events	284
8.2.2 Nuclear safety analysis for accident situations	284
8.2.3 Measures to prevent or mitigate significant adverse effects	286
8.2.4 Emergency planning and preparedness	287
8.3 Risks associated with the CTRF project.....	288
8.3.1 Risks associated with hazardous materials handling operations	288
8.3.2 Risks associated with fires and explosions	288
8.3.3 Risks associated to failure.....	291
8.3.4 Risks associated with natural disasters	291
8.4 Description of prevention measures and response to accidents and adverse events.....	294
9. NON-TECHNICAL SUMMARY	294
10. LIST OF REFERENCES	306
ANNEXES.....	311
Annex 1 CTRF General arrangement	311
Annex 2 CTRF layout	312
Annex 3 Location alternative 1	313
Annex 4 Location alternative 2	314
Annex 5 Populations of plant species of conservation interest reported in Natura 2000 sites in the Area of Interest.....	315
Annex 6 Populations of invertebrate species of conservation interest reported in Natura 2000 sites in the Area of Interest	315
Annex 7 Populations of fish species of conservation interest reported in Natura 2000 sites in the Area of Interest.....	316
Annex 8 Populations of amphibian species of conservation interest reported in Natura 2000 sites in the Area of Interest.....	318
Annex 9 Populations of reptilian species of conservation interest reported in Natura 2000 sites in the Area of Interest.....	318
Annex 10 Populations of mammal species of conservation interest reported in Natura 2000 sites in the Area of Interest	319
Annex 11 Populations of bird species of conservation interest reported in Natura 2000 sites in the Area of Interest.....	320
Annex 12 Spatial distribution of atmospheric concentrations of pollutants generated during the construction phase	344
Annex 13 Spatial distribution of atmospheric concentrations of pollutants generated during operation ..	348
Annex 14 Spatial distribution of atmospheric concentrations of pollutants "all sources" at the NPP location	358
Annex 15 Spatial distribution of atmospheric concentrations of pollutants in the context of "all sources" at the NPP and CTRF locations	362

List of figures

No.	Name	Page
1.	Figure 1.1.1.1 Location of the CTRF project site inside the Cernavoda NPP	22
2.	Figure 1.1.3.1 Distances to the nearest borders	23
3.	Figure 1.2.2.3.1 Schematic diagram of the isotope exchange plant-LPCE	27
4.	Figure 1.2.2.3.2 Schematic diagram of the cryogenic distillation system - CDS	29
5.	Figure 1.2.2.3.3 WTRF-Korea tritium gas handling and storage system	30
6.	Figure 1.2.3.4.1 Map of land areas occupied by each of the permanent components of the CTRF project	33
7.	Figure 1.3.1.1 CTRF block diagram	44
8.	Figure 1.3.1.2 HWFS Tritiated Heavy Water Feed System (Unit 1)	45
9.	Figure 1.3.1.3 HWFS Tritiated Heavy Water Feed System (Unit 2)	45
10.	Figure 1.3.1.4 Catalytic isotopic exchange columns. Vertical section through the CTRF building	48
11.	Figure 1.3.1.5 Catalytic isotopic exchange columns. Horizontal section through the CTRF building	49
12.	Figure 1.3.1.6 Container model for storing tritium on a titanium bed at WTRF-Korea	50
13.	Figure 1.3.1.7 Product heavy water supply system (detrified heavy water) HWPS - Unit 1	51
14.	Figure 1.3.1.8 Product heavy water supply system (detrified heavy water) HWPS - Unit 2	52
15.	Figure 1.4.13.1 Distribution of the dispersion coefficient according to the distance from the stack at ground level (operation of a Diesel group - backup generator)	85
16.	Figure 1.4.13.2 Distribution of the dispersion coefficient according to the distance from the stack at ground level (operation of two Diesel groups - backup generator)	85
17.	Figure 1.4.14.1 Simulation of atmospheric dispersion of tritium	86
18.	Figure 1.4.14.2 Location of investigation points for tritium concentrations in the air according to the environmental radiological monitoring program by Cernavoda NPP	88
19.	Figure 1.4.14.3 Distance variation of empirical atmospheric dispersion factors, determined on the basis of monitoring data from 2006-2018	89
20.	Figure 2.1 The evolution of tritium activities emitted in the environment, in the form of liquid effluents, by Cernavoda NPP, during the entire period of operation, from the commissioning of the first unit	93
21.	Figure 2.2 The evolution of tritium activities emitted in the environment, in the form of gaseous effluents, by the two CANDU units of Cernavoda NPP	93
22.	Figure 3.1.1 CTRF project location	104
23.	Figure 3.1.1.1 The Danube River in the area of the Cernavoda NPP site	105
24.	Figure 3.1.3.1.1 Annual average values of tritium concentration in surface water samples	109
25.	Figure 3.1.3.1.2 Annual average values of global beta activity in surface water samples	109
26.	Figure 3.1.3.1.3 Global beta specific activity in drinking water samples in the period 2007-2020	112
27.	Figure 3.1.3.1.4 Global specific beta activity in groundwater samples in the period 2007-2020	112
28.	Figure 3.1.3.1.5 Specific concentration of H-3 in drinking water samples during 2007-2020	113
29.	Figure 3.1.4.1 Annual average pH values in liquid effluent	116
30.	Figure 3.1.4.2 Annual average values for hydrazine concentration in the liquid effluent	116
31.	Figure 3.1.4.3 Annual average values for the concentration of morpholine in the liquid effluent	116
32.	Figure 3.1.4.4 Annual average values for the concentration of lithium in the liquid effluent	116
33.	Figure 3.1.4.5 Annual average values for the concentration of biochemical oxygen consumption in the liquid effluent	117
34.	Figure 3.1.4.6 Annual average values for the concentration of solid suspensions in the liquid effluent	117
35.	Figure 3.1.4.7 Annual average values for the concentration of solid suspensions in the liquid effluent	117

36.	Figure 3.1.4.8 Annual average values for the concentration of chlorides in the liquid effluent	117
37.	Figure 3.1.4.9 Annual average values for sulphate concentration in liquid effluent	118
38.	Figure 3.1.4.10 Annual average values for the concentration of sodium in the liquid effluent	118
39.	Figure 3.1.4.11 Annual average values for the concentration of magnesium in the liquid effluent	118
40.	Figure 3.1.4.12 Annual average values for the concentration of calcium in liquid effluent	118
41.	Figure 3.2.1.1 Annual average values for the variation of the global specific beta activity in the air for distances greater than 10 km	120
42.	Figure 3.2.1.2 Annual average values for the variation of the global specific beta activity in the air for distances between 5 km and 10 km	121
43.	Figure 3.2.1.3 Annual average values for the variation of the global specific beta activity in the air for distances between 1 km and 5 km	121
44.	Figure 3.2.1.4 Annual average values for the variation of the global specific beta activity in the air for the exclusion zone	122
45.	Figure 3.2.1.5 Variation in the concentration of H-3 in the air for distances greater than 10 km	124
46.	Figure 3.2.1.6 Variation in the concentration of H-3 in the air for distances between 5 km and 10 km	124
47.	Figure 3.2.1.7 Variation in the concentration of H-3 in the air for distances between 1 km and 5 km	125
48.	Figure 3.2.1.8 Variation in the concentration of H-3 in the air for the exclusion zone	125
49.	Figure 3.2.1.9 The average specific concentration of H-3 in humid atmospheric deposits for the period 2005-2020	127
50.	Figure 3.2.1.10 Annual average C-14 airborne values for 2011-2020	128
51.	Figure 3.3.2.1 Geological map in the area of the Cernavoda NPP platform	130
52.	Figure 3.3.4.1 Map of land use in the area of the Cernavoda NPP platform	133
53.	Figure 3.3.4.2 The share of different types of land use within a radius of 30 km around Cernavoda NPP	134
54.	Figure 3.4.1 CLC map within a radius of 30 km from the CTRF project location	136
55.	Figure 3.4.2 Map of Natura 2000 sites located within a radius of 30 km from the CTRF project location	136
56.	Figure 3.4.3 Cyclogram on the distribution of sites of conservation interest to the site	137
57.	Figure 3.5.1 Wind rose at Cernavoda Weather Station 2001-2017 Annual wind direction and speed threshold (hourly data)	170
58.	Figure 3.5.2 Distribution of frequencies (in percentages) by average daily wind speed classes, in Cernavoda, in the period 2001-2017 (hourly data)	170
59.	Figure 3.5.3 Distribution of frequencies (in percentages) by wind speed classes in Cernavoda, in the period 2001-2017 (hourly data)	171
60.	Figure 3.5.4 Forecast changes in maximum daily temperatures of the hottest days in the period 2080-2099 according to RCP8.5 (compared to 1986-2005)	173
61.	Figure 3.5.5 Expected changes in monthly precipitation in Cernavoda in the period 2080-2099 according to RCP8.5 (compared to 1986-2005)	175
62.	Figure 3.5.6 Expected changes in precipitation from the days when a very large amount of precipitation is recorded in Cernavoda in the period 2080-2099 according to RCP8.5 (compared to the reference 1986-2005)	176
63.	Figure 3.5.7 Walter-Lieth Climate Chart for 2011-2020 (Multiannual Monthly Averages)	180
64.	Figure 3.5.8 Spatial distribution of tornadoes in Romania	181
65.	Figure 3.7.1 Noise map for normal operation	191
66.	Figure 3.7.2 3D noise map for normal operation	191
67.	Figure 3.7.3 Location of noise measurement points outside the NPP site	193
68.	Figure 3.8.1 Spatial variation of the number of inhabitants in the localities in the area of influence of the CTRF project	196
69.	Figure 4.5.1.1 The average increase of the monthly average value of the maximum daily temperature in the period 2018-2057 compared to 1971-2010, under the conditions of the RCP 4.5 scenario	224
70.	Figure 4.5.1.2 The average increase of the monthly average value of the maximum daily temperature in the period 2018-2057 compared to 1971-2010, under the conditions of the RCP scenario 8.5	224

71.	Figure 4.5.2.1 The evolution of the Palmer Index of Drought Severity (in standardized units) observed (1970-2005; black line), simulated (1970-2005): gray band and gray line representing all regional models used) and projected into the future (2006-2100; gray band and gray line representing all regional models used), Climate scenario used is moderate (RCP 4.5)	226
72.	Figure 4.5.2.2 The evolution of the Palmer Index of Drought Severity (in standardized units) observed (1970-2005; black line), simulated (1970-2005): gray band and gray line representing all regional models used) and projected into the future (2006-2100; gray band and the gray line representing all the regional models used), the climate scenario used is the worst case one (RCP 8.5)	226
73.	Figure 4.5.3.1 Probability density calculated using the Burr distribution (4P) for the histogram of the absolute maximum amounts of precipitation falling in 24 hours in the area of the 3 analyzed stations (1962-2017)	227
74.	Figure 4.5.5.1 The average change in the average monthly value of the maximum wind speed, in the period 2018-2057 compared to 1971-2010, under the conditions of the RCP 4.5 scenario	231
75.	Figure 4.5.5.2 The average change in the average monthly value of the maximum wind speed, in the period 2018-2057 compared to 1971-2010, under the conditions of the RCP scenario 8.5	231
76.	Figure 4.7.1.1 Annual emissions of tritium in the form of liquid effluents from Cernavoda NPP	241
77.	Figure 4.7.1.2 Annual tritium emissions in the form of gaseous effluents from Cernavoda NPP	241
78.	Figure 4.8.1 CTRF operating graph for reactors 1 and 2 with a proposed operating target of 10 Ci / kg	247
79.	Figure 5.2.6.1 Noise map for CTRF operation	264
80.	Figure 5.2.6.2 3D noise map for CTRF operation	264
81.	Figure 5.5.1 The time variation of the tritium residence fraction following an acute soil contamination	272

List of tables

No.	Name	Page
1.	Table 1.2.2.1 CTRF project implementation schedule	26
2.	Table 1.2.3.3.1 Expected territorial balance for the CTRF objective	33
3.	Table 1.2.5.1 Types and quantities of chemicals used during construction	34
4.	Table 1.2.6.1 The main types of waste that can be generated during the construction / assembly stage of the CTRF installation	35
5.	Table 1.2.7.1 Natural resources and raw materials used in the project	37
6.	Table 1.2.14.1 Relevant existing or future projects on the Cernavoda NPP site	41
7.	Table 1.3.1.1 Technical characteristics for the catalyst types mentioned	47
8.	Table 1.3.2.1 Raw materials used for the operation of the CTRF installation	52
9.	Table 1.3.6.1 Estimated quantities of hazardous materials used, stored or handled during operation	58
10.	Table 1.4.2.1 Estimated amounts of non-radioactive waste generated during the construction period	63
11.	Table 1.4.3.1 Estimated amounts of non-radioactive waste generated during operation	64
12.	Table 1.4.3.2 Estimated main amounts of radioactive waste generated during operation	65
13.	Table 1.4.4.1 Estimated amounts of non-radioactive waste generated during decommissioning	66
14.	Table 1.4.4.2 Estimated quantities of radioactive waste generated during the decommissioning period	66
15.	Table 1.4.8.1 Dispersion parameters for H-3 and C-14 radionuclides [3]	75
16.	Table 1.4.9.1.1 Types / quantities of gaseous emissions generated by the project	76
17.	Table 1.4.9.1.2 Tritium activity concentration (Bq / kg) measured within the environmental monitoring program of Cernavoda NPP in 2020	77
18.	Table 1.4.9.2.1 Emissions from burning fossil fuels from stationary sources - Diesel generator	78
19.	Table 1.4.9.2.2 Results of the evaluations for the average levels of tritium activity concentrations in gaseous radioactive emissions for the normal operation of CTRF installations and U1 and U2 units from Cernavoda NPP	79
20.	Table 1.4.12.1 Construction and functional characteristics of ventilation stacks	82
21.	Table 1.4.13.1 Parameters used in the calculation of dispersion factors for gases from Diesel groups - backup generator	82
22.	Table 1.4.14.2 Concentrations calculated at an average ambient temperature of 22 ° C, average wind speed > 6 m / s, at 0 m from the ground (1 diesel generator in operation)	83
23.	Table 1.4.13.3 Concentrations calculated at an average ambient temperature of 22°C, average wind speed > 6 m / s, at 0 m from the ground (2 diesel generators in operation)	83
24.	Table 1.4.13.4 Dispersion coefficients for pollutants taken into account under the conditions described above (1 diesel generator in operation)	84
25.	Table 1.4.13.5 Dispersion coefficients for pollutants taken into account under the conditions described above (2 diesel generators in operation)	84
26.	Table 1.4.14.1 The values of the dispersion factors	87
27.	Table 1.4.14.2 Statistical analysis of the set of values for the empirical dispersion factors in the monitoring locations	89
28.	Table 2.1.2.1 The impact of the variants of the location of the tritium removal installation in the perimeter of Cernavoda NPP, on the environmental factors possible to be affected	97
29.	Table 2.1.3.1 The potential impact on the comparative environment of the 3 alternatives - zero, on-site and off-site	101
30.	Table 3.1.3.1.1 Results of the monitoring carried out by ICSI Rm. Vâlcea in September 2020	110
31.	Table 3.1.3.1.2 The content of alpha-emitting radionuclides (actinides), originating from the nuclear activities on the Cernavoda NPP platform in the surface water of the Seimeni canal	110
32.	Table 3.1.3.1.3 The content of alpha-emitting radionuclides (actinides), originating from the nuclear activities on the Cernavoda NPP platform in the sediment of the Seimeni canal	111
33.	Table 3.1.3.1.4 The results of the monitoring from the domestic water network on the Cernavoda NPP platform	111

34.	Table 3.1.3.1.5 Monitoring results from drinking water and deep groundwater	113
35.	Table 3.1.3.1.6 Dispersion parameters for H-3 and C-14 radionuclides	114
36.	Table 3.2.1.1 Location of sampling points	120
37.	Table 3.2.1.2 Global beta activity and concentration activity of radiation emitting gamma radionuclides from locations in the vicinity of the CTRF site	122
38.	Table 3.2.1.3 Gamma-emitting radionuclides, specific to Cernavoda NPP	123
39.	Table 3.2.1.4 Results of determinations of alpha-emitting radionuclides (actinides)	123
40.	Table 3.2.1.5 Values of tritium concentration in the water from atmospheric air in 2020	126
41.	Table 3.2.1.6 Estimation of tritium concentrations	126
42.	Table 3.2.1.7 Alpha-emitting radionuclides in wet atmospheric deposits in the vicinity of the CTRF site	127
43.	Table 3.2.1.8 C-14 concentration in atmospheric air, determined by ICSI Rm Valcea for locations in the vicinity of CTRF	128
44.	Table 3.2.1.9 Estimation of C-14 concentration	128
45.	Table 3.2.1.10 Empirical dispersion factors for C-14 in the three monitoring locations in the vicinity of the plant	129
46.	Table 3.4.1 Habitat Types (Corine Land Cover, 2018)	135
47.	Table 3.4.2 Sites located within a 30 km radius of the CTRF project location	137
48.	Table 3.4.3 Presence of existing habitats in areas of interest for nature protection	141
49.	Table 3.5.1 Maximum wind speed (m / s) with different probabilities, respectively, return periods, in the Cernavoda area	171
50.	Table 3.5.2 Extreme temperatures	172
51.	Table 3.5.3 Maximum precipitations in 24 hours (mm), monthly and annual and the date of production at the Cernavoda, Fetești and Medgidia meteorological stations	174
52.	Table 3.5.4 Maximum amount of precipitation in 24 hours with different probabilities, respectively, return periods in the Cernavoda area	175
53.	Table 3.5.5 The maximum thickness of the snow layer (in cm) with different probabilities, respectively, return periods, in the Cernavoda area (with historical data covering the period 1945-2017, from the 3 analyzed weather stations)	176
54.	Table 3.5.6 Average monthly and annual number of blizzard days (1961 - 2017)	177
55.	Table 3.5.7 The absolute maximum number, monthly and annually, of blizzard days (1961 - 2017)	177
56.	Table 3.5.8 Absolute maximum number, monthly and annual, of hail days	178
57.	Table 3.5.9 International TORRO hail scale	179
58.	Table 3.5.10 Absolute maximum monthly and annual number of stormy days	180
59.	Table 3.5.11 Fujita scale of tornado intensity and associated effects in Europe	181
60.	Table 3.6.1 Dose conversion factors for exposure routes originating in gaseous emissions	183
61.	Table 3.6.2 Conversion factors established for exposure assessment in the case of exposure routes originating from liquid effluents	183
62.	Table 3.6.3 Annual averages of H-3 activity concentration in representative samples for affected environmental compartments	185
63.	Table 3.6.4 Annual emissions of H-3 and C-14 in radioactive gas effluents released by Cernavoda NPP and annual LDE values	185
64.	Table 3.6.5 Annual activity for H-3 and C-14 released by liquid effluents by Cernavoda NPP, in the period 2010 - 2020	186
65.	Table 3.6.6 Annual effective doses for H-3 in gaseous effluents	187
66.	Table 3.6.7 Annual effective doses for C-14 in gaseous effluents	187
67.	Table 3.6.8 Annual effective doses for H-3 in liquid effluents	188
68.	Table 3.6.9 Annual effective doses for C-14 in liquid effluents	188
69.	Table 3.6.10 Estimated results for the maximum effective dose of exposures due to releases of liquid and gaseous effluents	189
70.	Table 3.6.11 Results calculated for the maximum effective dose due to C-14 issued in the form of liquid and gaseous effluents by Cernavoda NPP, in the period 2010-2020	189
71.	Table 3.6.12 Additional effective doses calculated for excess against natural background	190
72.	Table 3.7.1 Noise sources located in Cernavoda NPP	190
73.	Table 3.7.2 Comparison between measured and estimated values	192
74.	Table 3.7.3 Summary of noise analysis results	192

75.	Table 3.8.1 The number of inhabitants of the localities within a radius of 30 km compared to the CTRF project	194
76.	Table 3.8.2 Population density in localities within a radius of 30 km in 2011	197
77.	Table 3.8.3 Industrial activities carried out in the area of influence of Cernavoda NPP	198
78.	Table 3.9.1.1 Archaeological sites registered at and near the National Archaeological Repertory of Cernavoda	201
79.	Table 3.9.1.2 List of archeological sites within a radius of 30 km around the site, other than those mentioned above	204
80.	Table 3.9.1.3 List of historical monuments in Cernavoda	204
81.	Table 4.1.2.1 The results of the physico-chemical analysis obtained for the monitoring point Danube Km 292 - Seimeni	208
82.	Table 4.1.2.2 The results of the physico-chemical analysis obtained for the monitoring point Saligny Bridge - Cernavoda	208
83.	Table 4.1.6.1 The results of physico-chemical analysis obtained for domestic water	211
84.	Table 4.2.1.1 Distance of aerosol sampling locations to the stack	213
85.	Table 4.3.1.1 Radiological characterization of soil samples - 2020	216
86.	Table 4.3.1.2 Radiological characterization of soil samples - 2021	216
87.	Table 4.3.2.1 Qualitative analysis of the soil environmental factor in terms of hydrocarbon contamination	217
88.	Table 4.4.1.1 Radiological monitoring for spontaneous vegetation - 2020	218
89.	Table 4.4.1.2 Radiological monitoring for spontaneous vegetation - 2021	219
90.	Table 4.5.1.1 Maximum annual temperature (in°C) with different probabilities, respectively, return periods, in the Cernavoda area (with data from the simulations in the conditions of the moderate increase of the greenhouse gas concentration - RCP 4.5, covering the period of 40 years (2018 -2057)	222
91.	Table 4.5.1.2 Maximum annual temperature (in°C) with different probabilities, respectively, return periods, in the Cernavoda area (with data from the simulations in the conditions of the worst case scenario of increasing the concentration of greenhouse gases - RCP 8.5, covering the period of 40 years 2018 -2057)	223
92.	Table 4.5.2.1 Maximum number of days of drought with various probabilities of occurrence	225
93.	Table 4.5.3.1 The maximum amount of precipitation in 24 hours with different probabilities, respectively, return periods, in the Cernavoda area (with historical data covering the period 1945-2017)	227
94.	Table 4.5.3.2 Maximum annual amount of precipitation in 24 hours (in mm) with different probabilities, respectively, return periods, in the Cernavoda area (with data from the simulations in the conditions of the scenario of moderate increase of the concentration of greenhouse gases - RCP 4.5, covering the period of 40 years 2018-2057)	228
95.	Table 4.5.3.3 The maximum annual amount of precipitation in 24 hours (in mm) with different probabilities, respectively, return periods, in the Cernavoda area (with data from the simulations in the conditions of the worst case scenario of increasing the concentration of greenhouse gases - RCP 8.5, covering the period of 40 years 2018 - 2057)	228
96.	Table 4.5.5.1 The maximum annual value of the maximum wind (in m / s) with different probabilities, respectively, return periods, in the Cernavoda area (with data from the simulations in the conditions of the moderate increase of the greenhouse gas concentration - RCP 4.5, covering the period of 40 years 2018 -2057)	229
97.	Table 4.5.5.2 The maximum annual value of the maximum wind (in m / s) with different probabilities, respectively, return periods, in the Cernavoda area (with data from the simulations in the conditions of the worst case scenario of increasing the concentration of greenhouse gases - RCP 8.5, covering the period of 40 years 2018 -2057)	230
98.	Table 4.5.8.1 Minimum annual temperature (in°C) with different probabilities, respectively, return periods, in the Cernavoda area (with data from historical simulations, covering the period 1970-2010)	232
99.	Table 4.5.8.2 Minimum annual temperature (in°C) with different probabilities, respectively, return periods, in the Cernavoda area (with data from the simulations in the conditions of the moderate increase of the greenhouse gas concentration - RCP 4.5, covering the period of 40 years 2018 -2057)	233
100.	Table 4.5.8.3 Minimum annual temperature (in°C) with different probabilities, respectively, return periods, in the Cernavoda area (with data from the simulations in	233

	the conditions of the worst case scenario of increasing the concentration of greenhouse gases - RCP 8.5, covering the period of 40 years 2018 -2057)	
101.	Table 4.6.2.1 Residential areas in administrative-territorial unit Cernavoda City	234
102.	Table 4.6.3.1 Distribution of the population by economic activities in the city of Cernavoda in 2011	235
103.	Table 4.7.1.1 Fractionation of dose constraints with respect to radioactive effluent emission pathways and radionuclides likely to be present in effluents	238
104.	Table 4.7.1.2 Derived evacuation limit values for tritium	239
105.	Table 4.7.1.3 Dose conversion factors for gaseous exposure routes	239
106.	Table 4.7.1.4 Dose conversion factors for liquid effluent exposure routes	239
107.	Table 4.7.1.5 Excess risk coefficients for calculating fatal cancer cases	240
108.	Table 4.7.2.1 Results of radioactivity analysis in fish samples - 2020	242
109.	Table 4.7.2.2 Results of radioactivity analysis in fish samples	242
110.	Table 4.7.2.3 Results of radioactivity analysis in milk samples - 2020	243
111.	Table 4.7.2.4 Results of radioactivity analysis from meat samples- 2020	243
112.	Table 4.7.2.5 Results of radioactivity analysis in meat samples - 2020	243
113.	Table 4.7.2.6 Results of radioactivity analysis in food samples of plant origin	244
114.	Table 4.7.2.7 Results of radioactivity analysis in food samples of plant origin	244
115.	Table 4.7.2.8 Results of radioactivity analysis in food samples of plant origin	245
116.	Table 5.2.2.1 Existing sources of non-radiological emissions and calculated emissions for the Cernavodă NPP site, detailed for each source	254
117.	Table 5.2.2.2 Concentrations calculated at an average ambient temperature of 22 ° C, average wind speed of > 6 m / s, at 0 m from the ground for non-radioactive emission sources existing at the Cernavoda NPP site	255
118.	Table 5.2.2.3 Dispersion coefficients for existing non-radioactive emission sources at the Cernavoda NPP site	256
119.	Table 5.2.6.1 Noise levels associated with CTRF elements - Sound pressure level, dB	262
120.	Table 5.2.6.2 Modeled noise levels at the Cernavoda NPP site boundary, dB (A)	263
121.	Table 5.5.1 Results of the evaluation of the radiological consequences of some events at CTRF, according to KI CTRF-00437 Rev 05	269
122.	Table 5.5.2 Modeling results for estimating soil deposits under the analyzed accident conditions	271
123.	Table 7.2.1 Measures to avoid, prevent, reduce or compensate for any significant adverse effects identified	277
124.	Table 8.1.1 Description of major accident scenarios identified and selected in the Preliminary Hazards Assessment - PHA analysis, with a summary of the triggering events for the proposed situation (with Detritiated Installation)	283
125.	Table 8.2.2.1 Dose criteria for analysis of project base events for nuclear installations	285

List of abbreviations

SNN	"Nuclearelectrica" National Society
CNE	Cernavoda Nuclear Power Plant
WSP – UK Ltd	WSP - United Kingdom Limited
CTRF	Cernavoda Tritium Removal Facility
RATEN ICN	Autonomous Directorate of Nuclear Energy Technologies - Institute for Nuclear Research
ICSI Rm. Vâlcea	National Research-Development Institute for Cryogenic and Isotopic Technologies Ramnicu-Valcea
INCDDD	"Danube Delta" National Institute for Research and Development
RIM	Environmental impact report
CNCAN	National Commission for Nuclear Activities Control
MMAP	Ministry of Environment, Waters and Forests
ABADL	Dobrogea - Litoral Water Basin Administration
ANM	National Meteorological Administration
ADS	Atmospheric tritium removal system
C-14	Radioactive carbon isotope with mass number 14
CANDU	CANadian deuterium uranium
CBO₅	Biochemical oxygen consumption every 5 days
CDMN	Danube-Black Sea Canal
CDS	Cryogenic Distillation System
CECE – CD	Combined Electrolysis and Catalytic Exchange – Cryogenic Distillation –
CLM	Climate Limited-area Modeling
CMA	Maximum allowable concentration
COG	Candu Owners Group
CO₂	Carbon dioxide
COV	Volatile organic compounds
CTP	Thermal Start-up Plant
D₂/DT/HD	Molecular species of hydrogen which have deuterium as their component
D₂O	Heavy water
DBE	Design Basis Earthquake
DCF	Dose conversion factor for ingestion
DE – CD	Direct electrolysis - cryogenic distillation
DFDSMA	Final Storage Facility for Low and Medium Active Waste
DICA	Intermediate Storage Facility for Spent Fuel
DIDSR	Intermediate Storage Facility for Radioactive Solid Waste
DJ	County Road
DTO	Tritiated heavy water
DTRF	Darlington tritium removal facility
ENEV	Expected no effect values
EWS	Emergency water pumping station
F_j	Boreholes (wells)
GES	Greenhouse gases

H.C.L.	Local Council Decision
H-3	Tritium. Radioactive hydrogen isotope with mass number 3
HIRHAM5	High Resolution Hamburg Area Model version 5
HTET	High tritium expansion tank
HVAC	Heating, ventilation and air conditioning system
HWFS	Heavy water feed system
IAEA	International Atomic Energy Agency
ISU	Inspectorate for Emergency Situations
ITC	Immobilized Tritium Container
LBD	Licensing basis document
LCM	Environment control laboratory
LCS	Heavy water drainage and collection system
LDE	Derived emission limits
LEL	Lower explosion limit
LMI	List of historical monuments
LPCE	Liquid phase catalytic exchange system
LPCE - CD	Liquid phase catalytic exchange - cryogenic distillation
LTET	Low tritium expansion tank
nMB	Reference elevation above the Baltic Sea level
MEL	Liquid effluent monitor
NDR	Fundamental rules for the safe management of radioactive waste
NEx	Regulations for the design, execution, verification and operation of electrical installations in hazardous areas
NO_x	Nitrogen oxide
NP	Design regulations
NSR	Norms of Radiological Safety
ONG	Non-governmental organization
OPEX	Operational experience
ALARA	As Low As Reasonable Achievable
PCA	Access control point
PEHD	High density polyethylene
PESTD	Experimental Pilot Facility for Separation of Tritium and Deuterium
PSAR	Preliminary safety analysis report
PSI	Prevention and firefighting
PVC	Polyvinyl chloride
PVC-KG	Type of non-plasticized polyvinyl chloride pipes, triple layer, used for sewers
RACMO	Regional climate model
RCA4 - IPSL	Rosby center regional climate model 4 - Institute Pierre Simon Laplace
RCA4 - MPI	Rosby Center Regional Climate Model 4 - Max Planck Institut für Meteorologie
RCA4-ICHEC	Rosby Center Regional Climate Model 4 - Irish Center for High End Computing
REACH	Registration, Evaluation, Authorization and Restriction of Chemicals
REMO	Regional model
RIM	Environmental impact report
RNMCA	National Air Quality Monitoring Network

SCI	Site of Community Importance
SDG	Stand-by Diesel Generator
SF	Feasibility study
SLD	Below the detection limit
SO₂	Sulphur dioxide
SPA	Avifauna Special Protection Area
STA	Water Treatment Plant
TGHSS	Tritium gas handling and storage system
TRS	Tritium retention system
U.T.R	Territorial Reference Unit
U1	Unit 1
U2	Unit 2
UAT	Territorial administrative unit (TAU)
UEL	Upper explosion limit
UNESCO	United Nations Educational, Scientific and Cultural Organization
VCE	Vapor cloud explosion
VPCE-CD	Vapour phase catalytic exchange - Cryogenic Distillation
WRF	Weather Research and Forecasting model
WTRF	Wolsong tritium removal facility
Zdl	Zone of influence
Measurement units	
Ci	Curie
Bq	Becquerel
dB	Decibel
kBq	KiloBecquerel
LAeq	Equivalent continuous sound level
Sv	Sievert

GENERAL INFORMATION

Introduction

This paper represents the Environment Impact Assessment Report for the project "**Construction works of the heavy water tritium removal facility**" (CTRF) at Cernavoda NPP, an investment made by Nuclearelectrica SA National Company, the beneficiary of the Report.

This project is located on the NPP Platform, Cernavoda city, Constanța county. This paper has been prepared in order to obtain the Environmental Permit for carrying out the investment.

The environmental impact assessment report was prepared at the request of the owner within the environmental impact assessment procedure, in accordance with the provisions of Law no. 292/2018 on assessing the impact of certain public and private projects on the environment.

Following the screening stage, the Ministry of Environment, Waters and Forests (MMAP) issued the Screening Stage Decision no. 1 of 23.12.2019, according to which the project is subject to the Environmental Impact Assessment procedure, being compliant, according to Law no. 292/2018 on the assessment of the impact of certain public and private projects on the environment, in Annex no. 2, point 13, letter a).

The environmental impact assessment report is drawn up in accordance with Annex no. 4 of Law no. 292/2018 on the assessment of the impact of certain public and private projects on the environment, taking into account the requirements of the MMAP transposed by the Guideline on issues relevant to environmental protection to be developed in the Environmental Impact Report, depending on the nature, size and location of the project no. DEICP / 8885 of 10.09.2020.

DSPJ Constanța issued the Sanitary Permit for Site location and Construction no. 14497 / 17.08.2020, while the the Environmental Impact Assessment Report for the CTRF Project was wrote. Also, the Water Management Permit from ANAR was applied for the decision of this authority being that it is not necessary to elaborate SEICA (ANAR letter no. 26518 / DSC / 23.12.2019).

In preparing this Report on the environment impact assessment of CTRF, the provisions of the following normative acts were also considered:

- Law no. 292/2018 on assessing the impact of certain public and private projects on the environment;
- Law no. 59/2016 on the control of major accident hazards involving dangerous substances;
- Law no. 95/2006 on health care reform, as subsequently amended and supplemented;
- Water Law no. 107/1996, with subsequent amendments and supplements;
- Law no. 111/1996 on the safe conduct, regulation, authorization and control of nuclear activities, as subsequently amended and supplemented;
- Law no. 22/2001 for the ratification of the Convention on Environmental Impact Assessment in a Transboundary Context, adopted at Espoo on 25 February 1991;
- Law no. 289/2015 for the acceptance of the second amendment to the Convention on Environmental Impact Assessment in a Transboundary Context, adopted at Espoo on February 25, 1991, ratified by Romania by Law no. 22/2001, adopted by Decision III / 7 of the Third Meeting of the Parties in Cavtat on 1-4 June 2004;
- Law no. 49/2011 for the approval of the Government Emergency Ordinance no. 57/2007 on the regime of protected natural areas, conservation of natural habitats, wild flora and fauna;
- Law no. 5/2000 on the approval of the National Territory Infrastructure Improvement with subsequent amendments and supplements;
- Law no. 104/2011 on ambient air quality with subsequent amendments and supplements;
- Law no. 249/2015 on package and waste package management;
- Law no. 301 / 27.11.2015 on establishing the requirements for the protection of the public health regarding radioactive substances in drinking water;

- Law no. 458/2002 on drinking water quality with subsequent amendments and supplements;
- Order 269/2020 on the approval of the general guide applicable to the stages of the environmental impact assessment procedure, the guide for environmental impact assessment in a transboundary context and other specific guidelines for different areas and categories of projects;
- Order no. 828/2019 on the approval of the Procedure and powers for issuing, amending and withdrawing the water management permit, including the procedure for assessing the impact on water bodies, the Content Standard of the technical documentation subject to approval, as well as the Framework Content of the Study on impact assessment on water bodies;
- Order no. 119/2014 of February 4, 2014 for the approval of the Norms of hygiene and public health regarding the living environment of the population, with the subsequent modifications and supplements;
- Order no. 994/2018 for the amendment and completion of the Norms of hygiene and public health regarding the living environment of the population, approved by the Order of the Minister of Health no. 119/2014;
- Order no. 1524/2019 for the approval of the Methodology for organizing studies to assess the impact of certain public and private projects on the health of the population;
- Order no. 3299/2012 for the approval of the methodology for conducting and reporting inventories on emissions of pollutants into the atmosphere;
- Order no. 19/2010 for the approval of the Methodological Guide on the adequate assessment of the potential effects of plans or projects on protected natural areas of Community interest with the additions and amendments in force (Order No. 262/2020 amending the Methodological Guide on the adequate assessment of the potential effects of projects on protected natural areas of community interest, approved by Order of the Minister of Environment and Forests No. 19/2010);
- Order no. 381/2004 on the approval of the Basic Sanitary Norms for the safe conduct of nuclear activities, with subsequent amendments and supplements;
- Order of the Minister of Health, of the Minister of National Education and of the President of the National Commission for the Control of Nuclear Activities no. 752 / 3.978 / 136/2018 for the approval of the Norms regarding the basic requirements of radiological safety;
- CNCAN Order no. 72 / 30.05.2003 approving the CNCAN Norms regarding the specific requirements for the quality management systems applied to the construction- installation activities for nuclear installations (NMC-08);
- CNCAN Order no. 145/2018 for the approval of the Norms regarding the estimation of the effective doses and of the equivalent doses due to the internal and external exposure;
- CNCAN Order no. 286 / 24.09.2004 (NMC 02) - Norms regarding the general requirements for the quality management systems applied to the construction, operation and decommissioning of nuclear installations, approved by the Order of the CNCAN President no. 66/2003, published in the Official Gazette of Romania, Part I, no. 681 bis of September 26, 2003, amended by Order no. 286/2004 of 27.08.2004 published in the Official Gazette of Romania, Part I, no. 874 of 24/09/2004;
- CNCAN Order no. 360/2004 - Norms regarding the calculation of the dispersion of radioactive effluents discharged into the environment by nuclear installations approved by Order of the President of CNCAN no. 360 / 20.10.2004 and published in the Official Gazette of Romania, Part I no.1.159 bis / 08.12.2004;
- CNCAN Order no. 361/2004 - The norms regarding the meteorological and hydrological measurements at the nuclear installations approved by the Order of the President of CNCAN no. 361 / 20.10.2004 and published in the Official Gazette of Romania, Part I no. 1,189 bis / 13.12.2004;
- Order no. 2202/2020 regarding the approval of the lists with the administrative-territorial units drawn up following the classification in the management regimes of the areas from the zones and agglomerations provided in annex no. 2 to Law no. 104/2011 on ambient air quality;

- Order of the Minister of Culture no. 2314/2004, with subsequent amendments and of the National Archaeological Repertory provided by Government Ordinance no. 43/2000 on the protection of the archaeological heritage and the declaration of some archeological sites as areas of national interest, republished, with the subsequent modifications and supplements;
- Emergency Ordinance no. 195/2005 on environmental protection, with subsequent amendments and supplements;
- Government Emergency Ordinance no. 92/2021 on the regime of waste products;
- Emergency Ordinance no. 57 of June 20, 2007 on the regime of protected natural areas, conservation of natural habitats, wild flora and fauna;
- Emergency Ordinance no. 5/2015 on waste electrical and electronic equipment;
- Decision no. 856/2002 on the record of waste management and for the approval of the list of wastes, including hazardous waste with subsequent amendments and supplements;
- Government Decision no. 431/2020 for the amendment and completion of the Government Decision no. 786/2014 on the approval of the List of installations and special objectives of national interest, financed from the funds of the Ministry of Education and Scientific Research;
- Government Decision no. 84/2019 on the issuance of the environmental permit for the National Society "NUCLEARELECTRICA" - SA - Branch "Cernavoda NPP - Unit No. 1 and Unit No. 2 of the Cernavoda Nuclear Power Plant";
- Government Decision no. 352/2005 regarding the modification and completion of the Government Decision no. 188/2002 for the approval of some norms regarding the discharge conditions in the aquatic environment - The norm regarding the wastewater discharge conditions in the sewerage networks of the localities and directly in the treatment plants, NTPA-002/2002;
- Government Decision no. 617/2014 on the establishment of the institutional framework and measures for the implementation of Regulation (EU) no. 528/2012 of the European Parliament and of the Council of 22 May 2012 on the making available on the market and use of biocidal products, as subsequently amended and supplemented;
- Government Decision no. 1061/2008 regarding the transport of waste on the Romanian territory;
- Decision no. 1425/2006 for the approval of the Methodological Rules for the application of the provisions of Law no. 319/2006 on the occupational health and safety;
- Directive 2000/60 / EC of the European Parliament and of the Council of 23 October 2000 establishing a framework for Community action in the field of water policy;
- Directive 2014/52 / EU of the European Parliament and of the Council of 16 April 2014 amending Directive 2011/92 / EU on the assessment of the effects of certain public and private projects on the environment (including annexes);
- Directive no. 49/2002 on the assessment and management of ambient noise;
- Council Directive 79/409 / EEC on the conservation of wild birds as amended by Directive 2009/147 / EC of 30 November 2009;
- Directive 2009/147 / EC of the European Parliament and of the Council of 30 November 2009 on the conservation of wild birds;
- Council of the European Union Directive 92/43/1992 on the conservation of natural habitats and of wild fauna and flora (Habitats Directive) - last amended in 2013 following Croatia's accession to the EU;
- NSR 21 - Standard for monitoring radioactive emissions from nuclear and radiological installations;
- NSR 22 - Standard for monitoring the radioactivity of the environment in the vicinity of a nuclear or radiological installation;
- NSR 23 - Rules for the calculation of the dispersion of radioactive effluents discharged into the environment by nuclear installations;
- NDR 01 - Fundamental norms for the safe management of radioactive waste;
- NDR 04 - Rules on limiting the release of radioactive effluents into the environment;
- NDR 03 - Rules on the classification of radioactive waste;

- I 9-2015 - Norm regarding the design, execution and operation of sanitary installations related to buildings, M.D.R.A.P(Ministry of Regional Development and Public Administration);
- NP 120-2014- Norm regarding the requirements for design, execution and monitoring of deep excavations in urban areas;
- NP 099-04 / 2005 - Norm for the design, execution, verification and operation of electrical installations in areas with danger of explosion;
- NCN-01 - Norm regarding the authorization of the execution of nuclear-specific constructions, NCN-01 approved by the Order of the CNCAN President no. 407/2005;
- NSN-02 - Nuclear safety standard for the design and construction of nuclear power plants;
- NSN-09 - CNCAN norms regarding the protection of nuclear power plants against fires and explosions;
- NEx 01-06 / 2007 - Explosion prevention regulations for the design, installation, commissioning, use, repair and maintenance of technical installations operating in potentially explosive atmospheres;
- NSN-22 - CNCAN rules regarding the authorization of nuclear installations.

Name of the investment objective:

"Construction works for the heavy water tritium removal facility"

Location and Address:

NPP platform, Cernavoda city, Constanța county

Project holder / Beneficiary:

SN Nuclearelectrica SA

Headquarters address:

Bucharest 010494 Sector 1
65 Polona Street, ZIP CODE 22-102
Tel: + 40 21 203 8200
Fax: + 40 21 316 9400
Email: office@nuclearelectrica.ro
Web: www.nuclearelectrica.ro

Cernavoda NPP branch

Address:

Cernavoda 905200
2. Medgidiei Street, ZIP CODE 42
Constanta County, Romania
Tel: + 40 241 239 340 ÷ 346
Fax: +40 241 239 266
Email: corespondenta@cne.ro

The developer of the Environmental Impact Assessment Report:

"Danube Delta" National Institute for Research and Development - DDNI Tulcea

Certificate of attestation Series RGX no. 077 / 25.11.2021, certified expert - main level for the elaboration of the following environmental studies in the fields of attestation: RIM1, RIM2, RIM3, RIM4, RIM6, RIM8, RIM11a, RIM11b, RIM11c, RIM13b; RA1, RA8, RA11b; RM1, RM3, RM11a, RM11b, RM12, RM13b; RS3, RS11c; BM1, BM3, BM8, BM11a, BM11c, BM13b; EA; EGCA; MB; issued by the Romanian Environmental Association 1988; valid until 25.11.2024.

Address:

Tulcea 820112
165 Babadag Street
Tulcea County, Romania
Tel: (+4) 0240 524546
Fax: (+4) 0240 533547
Email: office@ddni.ro
Web: www.ddni.ro

1. PROJECT DESCRIPTION

1.1 Project location

1.1.1 General description of the site

The project "Construction works for the heavy water tritium removal facility" - CTRF will be developed on the current site of Cernavoda NPP, in Constanța County at approx. 2 km southeast of the town of Cernavoda, approx. 1.5 km northeast of the first lock of the Danube-Black Sea waterway, on the land in the area of the platform resulting from the excavations of the former limestone quarry "Ilie Barza".

The NPP site is bordered on the north by the Cișmelei Valley, and on the southwest by DJ 223(county road). The land inside the Cernavoda NPP, on which the CTRF project will be built, is located in the fixed front of the power plant and is limited by the slope towards Saligny Hill and the main road from the NPP premises - which allows access from the PCA1 gate to the Water Treatment Plant (STA), the Thermal Start-up Plant (CTP) and leads to the Intermediate Storage Facility for Radioactive Solid Waste (DIDSR). On one side it is partially bordered by a concrete wall which acts as protection against explosion (Figure 1.1.1.1).



Figure 1.1.1.1 Location of the CTRF project site inside the Cernavoda NPP

1.1.2 Land use regime in the site area

In accordance with the legislation in force in the nuclear field, the lands related to the Cernavoda NPP site will be used only with the approval of the National Commission for Nuclear Activities Control, allowing only constructions related to the operation of the Nuclear Power Plant.

The legal situation of the land on which the CTRF project is located was established by the Decree of the State Council no. 31 / 27.01.1986 (for the construction of Cernavoda NPP Units 1-5), the land being expropriated.

The land occupied by Cernavoda NPP and implicitly CTRF is the property of SNN SA according to the Certificate of attestation of the ownership right over the lands, series M03 no. 5415 issued by the Ministry of Industries and Resources, on 25.04.2000. According to the Urbanism Certificate no. 97 of 16.05.2018 the land on which the CTRF project is located [1]:

- is located in the town of Cernavoda, Constanța County, according to PUG (General Urban Plan) approved by HCL (Local Council Decision) no. 242/2014;
- is located in UTR A3 - subzone of production units related to NPP.

1.1.3 Distance to the Borders of Bulgaria, Ukraine and the Republic of Moldova

The Project falls under the Convention on Environmental Impact Assessment in a Transboundary Context, adopted at Espoo on 25 February 1991, ratified by Law no. 22/2001, with subsequent supplements.

Figure 1.1.3.1 shows the distance from the Cernavoda NPP site to the borders of the nearest states in the vicinity of Romania [1].

- approx. 36 km from Bulgaria;
- approx. 110 km from Ukraine;
- approx. 127 km from the Republic of Moldova.



Figure 1.1.3.1 Distances to the nearest borders

1.1.4. Objectives located in the vicinity of the site

The objectives located in the vicinity of the CTRF project site are the following (Annex 1): Drinking Water Pumping Station, Drinking Water Tanks, Diesel Pump Station, Diesel Tanks, Stand-by Diesel Generator Groups, Technical Gas Storage, Demineralized Water Storage Tanks, Power

Output Transformers, Chillers Unit, Start-up Power Plant, Own Services Electric Unit, Pipe Support (from Unit 0).

The distances from the CTRF project site to these points are as follows:

- 34 m from the Drinking Water Pumping Station;
- 20 m from the Drinking Water Tanks;
- 19.5 m from the Diesel Pump Station;
- 35 m from the Diesel Tanks;
- 44 m from the Stand-by Diesel Generator Groups;
- 49 m from the Technical Gas Storage;
- 45 m from the Demineralized Water Storage Tanks;
- 100 m from the Power Output Transformers;
- 90 m from the Chillers Unit;
- 75 m from the Start-up Thermal Power Plant;
- 120 m from the Common Station Services Electric Unit;
- 25 m from the Pipe Support (from Unit 0).

1.1.5 The distances between the location of the works and the objectives of interest

The public interest objectives, distance from human settlements, respectively from historical and architectural monuments, other areas on which there is a restricted regime, areas of traditional interest, etc.

Around each nuclear unit the following are established:

- *exclusion zone with a radius of 1 km* - in which no other activities are admitted than those carried out within the NPP; Measures are taken to exclude the location of permanent residences for the population and the development of socio-economic activities that are not directly related to the functioning of the nuclear objectives of the Cernavoda NPP.
- *sparingly populated area* - within a radius of 2 km from the nuclear objective - in which measures are taken to restrict the location of permanent residences for the population and the development of socio-economic practices.

The closest localities in the area of influence of Cernavoda NPP as a whole are [1]:

- The city of Cernavoda with 18602 persons domiciled on January 1, 2020 - located at approx. 1.6 km NW compared to the NPP-Cernavoda platform;
- The village of Stefan cel Mare with a population of approx. 546 inhabitants in 2011 – located approx. 2 km SE of Cernavoda NPP.

The localities Seimeni (about 8.1 km), Capidava (about 19.5 km) and Topalu (about 25.3 km) are located downstream of the discharge of the cooling water from NPP Cernavoda into the Danube.

The Cernavoda NPP platform is located in an area with a concentration of the built cultural heritage of national interest in the territory - Cernavoda city, Mircea Voda and Topalu communes [1].

The location of the site in relation to the cultural heritage according to the List of Historical Monuments, updated, approved by the Order of the Minister of Culture no. 2314/2004, with subsequent amendments and the National Archaeological Repertory provided by Government Ordinance no. 43/2000 on the protection of the archaeological heritage and the declaration of some archaeological sites as areas of national interest, republished, with subsequent amendments and supplements

The nearest are the archeological sites from Axiopolis - approx. 2.6 km VSV, medieval settlement Dealu Viforului - approx. 3.6 km VSV and Valul de piatră de la Cernavodă - approx. 2.7 km VSV.

Among the closest representative historical monuments in the city of Cernavoda is Geamia ~ 3 km, the Church "Sf. Împărați Constantin și Elena" ~ 3.5 km and Carol I Bridge with the statues "Dorobanții" ~ 4 km. The following historical monuments can be found at a distance of up to 30 km from the NPP platform: Cetatea Capidava ~ 20 km (Capidava locality), Cetatea Sacidava ~ 25 km (Dunăreni locality) and the "Inginer Anghel Saligny " Bridge - approx. 3.8 km VNV.

1.2 The physical characteristics of the whole project

1.2.1 The need for the project

SNN - SA Cernavoda NPP Branch currently owns 2 nuclear power units in commercial operation, Unit 1 since December 1996, and Unit 2 since October 2007, each being equipped with a CANDU 6 –PHWR (Canadian Deuterium Uranium 600 MWe - Pressurized Heavy Water Reactor, with a thermal power of 2061.4 MWt and a turbogenerator with an electric power of 706,5 MWe. For Units 1 and 2 of Cernavoda NPP, the Environmental Permit was issued, by GD no. 84/2019 replacing the Environmental Permit issued by GD 1515/2008, which in turn replaced the Environmental Permit No. 2 of 23.08.2005 (GD 1008/2005).

In a CANDU reactor that uses heavy water in nuclear systems as a moderator and primary heat transfer agent (coolant), tritium is produced by the transformation of deuterium (the isotope of hydrogen in the heavy water component) under the influence of neutron fields, resulting in generation of tritiated heavy water (DTO). In the normal operation of a CANDU reactor, the concentration of tritium formed in heavy water increases to a steady state, in which the formation of tritium is balanced by its radioactive decay.

For the typical CANDU-6 reactor, the steady state tritium level is reached after 2/3 of the reactor's life cycle. By operating CTRF the value of tritium concentration for heavy water in the Moderator System will be reduced from 80-90 Ci / kg to about 10 Ci / kg and below 2-2.5 Ci / kg for the heavy water in the Primary Heat Transport System.

The tritium concentration of the heavy water moderator when feeding the CTRF installation is max. 54 Ci / kg. For higher values of tritium concentration, in the first months of operation of the plant, its reduction will be achieved by dilution with heavy water with low tritium concentration. As, for Unit 1, the concentration of tritium in the moderator circuit has exceeded the CTRF operating limit, initially the supply to the plant will be performed by reducing this concentration by dilution with virgin heavy water. Thus, if a concentration of 85 Ci / kg is considered in the U1 moderator circuit, a dilution of approximately 1.6 times will be required for the first portion transferred to CTRF. This dilution will gradually decrease until the supply can be made directly without dilution.

The CTRF installation planned to be carried out by this Project will take over alternately and will ensure the Tritium removal of the heavy water used in the nuclear systems from the U1 and U2 reactors of Cernavoda NPP [1]. The Tritium removal plant will be used in the operation phases of U1, respectively of U2 Cernavoda NPP and in the decommissioning phase of U1 and U2 Cernavoda NPP. CTRF will reduce the amount of radioactive waste resulting from the decommissioning phase of U1 and U2 Cernavoda NPP, by removing the tritium from the heavy water used by the two reactors.

The CTRF installation can ensure the Tritium removal of tritiated heavy water from the nuclear systems of the future project Cernavoda NPP Units 3 and 4, in this case the value at which the tritium concentration will be reduced in the moderator of each unit will be established as well as the way of transfer of the heavy water units from Units 3 and 4 to the CTRF.

The CTRF project represents a concretization at the highest level of the continuous commitment of Cernavoda NPP for improving the environmental performance and reducing the discharge of tritium into effluents, with a positive impact on the protection of the population and the environment, while ensuring the reduction of workers' occupational exposure to tritium, with a positive impact on ensuring the protection of staff health.

The performance and implementation of the project avoids the classification of tritiated heavy water as radioactive waste at the end of nuclear reactor operation and the inclusion of management stages of this category of radioactive waste in the decommissioning plan of Units 1 and 2 Cernavoda NPP, thus avoiding the need to manage larger volumes of radioactive waste, including its final disposal.

The implementation of the CTRF project has a positive impact because it allows a significant reduction of the total inventory of tritium (radioactive isotope of hydrogen) from the CANDU type Nuclear Power Plant by:

- reducing the level of risks of generating radioactive effluents and emissions of tritium in the environment, risks associated with the transport of a large amount of heavy water with a high concentration of tritium through the nuclear systems of the plant,
- reducing staff exposure and reducing the cost of providing personal radiation protection equipment.

1.2.2 The program for the implementation of the project

The major steps in the implementation of the CTRF project are the following:

- Awarding the implementation contract of the project "Engineering Procurement Construction" - 2022;
- Completion of the detailed design by the contractor to be able to start the supply of components with a long delivery period "long lead items" -2022;
- Start of construction and installation works - 2023;
- Commissioning - 2024;
- Trial operation - 2025 - 2026 (6 months from PIF);
- Transfer to operation - 2026.

1.2.2.1 The main stages of the project

The implementation of the project involves the following main steps:

- Completion period - which includes construction - installation activities, technological tests / commissioning;
- Operating period;
- Decommissioning of the installation;
- Subsequent restoration of the area.

1.2.2.2 Estimated duration

The estimated duration is presented in the CTRF Project Implementation Chart (Table 1.2.2.1).

Table 1.2.2.1 CTRF project implementation schedule

Major stages of CTRF project implementation	2022		2023		2024		2025		2026	
Award of the implementation contract for the project "Engineering Procurement Construction"	■	■								
Completion of the detailed design for the start-up by the contractor of the "long lead items" supply	■	■								
Carrying out construction and installation works			■	■	■					
Commissioning							■	■		
Trial operation (6 months from PIF)									■	
Transfer to operation										■

1.2.2.3 Description of main components of the project, including associated / auxiliary works and facilities for public safety and environmental protection

The description of the project used for the environmental impact assessment in this Report is based on the conceptual design documentation produced so far. Following the development of the details design and completion of the equipment configuration, some deviations may occur from the data considered in the conceptual project. The beneficiary of the installation will follow these possible deviations and will ensure that they will be in the direction of improving the project, without negatively affecting the environmental impact assessments in this Report.

The technological systems part of the CTRF that ensure the reduction of the tritium content in heavy water, its separation and storage (T2) are structured as follows: main process systems and operational support systems, presented below [1].

A. Three main technological systems:

1. Liquid phase catalytic exchange - LPCE (The flow diagram in principle is shown in Figure 1.2.2.3.1) constitutes the initial "front-end" area of the installation and has as main elements [1]:

- a) isotope exchange columns (which are equipped with mixed catalytic packing);
- b) one temporary storage vessel of tritiated heavy water (supply) and detritiated (heavy water product);
- c) purification-drying of the process gas containing tritiated deuterium in order to supply the cryogenic distillation system (CD);
- d) process compressors, which transport the process gas in the closed circuit between the LPCE and the CD;
- e) process pumps, which ensure the circulation of heavy water in the LPCE system and the return to U1, U2, after tritium removal.

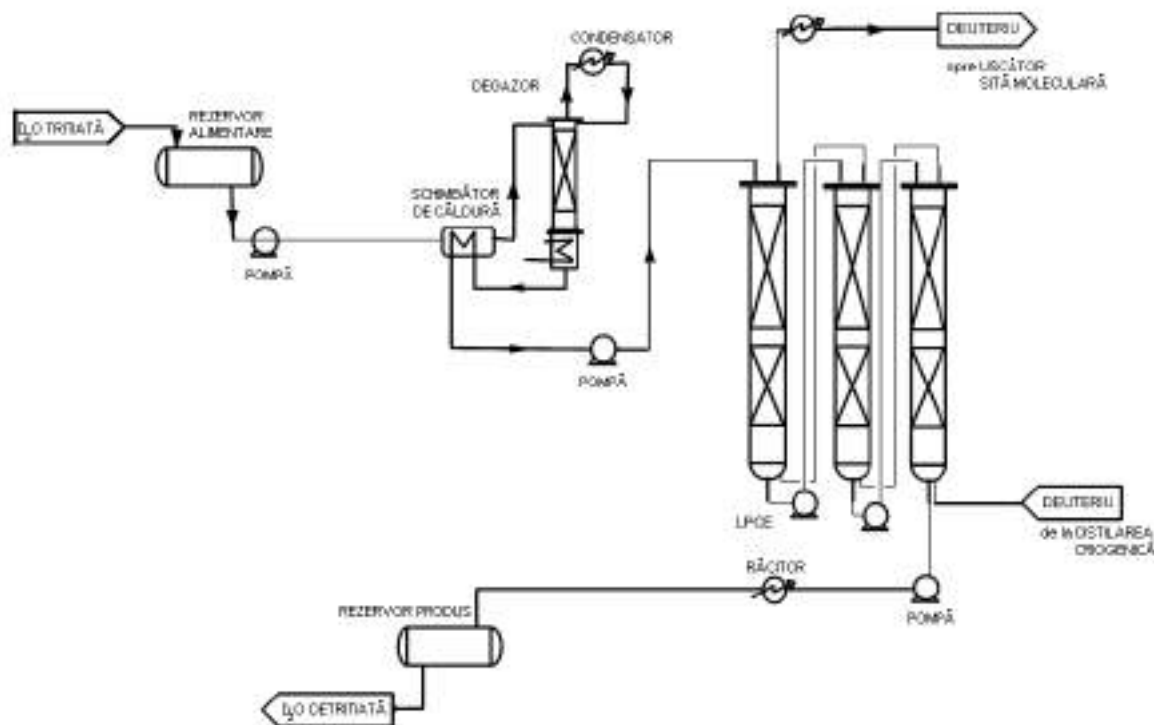

Figure 1.2.2.3.1 Schematic diagram of the isotope exchange system-LPCE

Source: "Nuclearelectrica" SA National Society, Presentation Memorandum - Construction works for Heavy Water Tritium Removal Facility, Variant for authorities - May 2019

Inputs to the LPCE system:

- *tritiated heavy water* (3,000 kg in campaigns, at a maximum interval of 3 days; heavy water process flow 40 kg / h, tritium content - 54 Ci / kg in the case of moderator heavy water from U1 or U2. The purification flow of the heavy water supply system is within the input limits for LPCE, it can be between 0.4 l / s and 1.1 l / s depending on the condition of the resin. This flow will ensure the purification of tritiated heavy water, necessary for the continuous operation of the Catalytic Isotopic Exchange System, according to 79-38570-613-DR-1 rev.2.
- *D₂ process gas*- supplied by the cryogenic distillation system (CDS). The initial inventory of D₂, as well as the subsequent make-up are obtained by electrolysis of virgin heavy water¹, within the deuterium gas supply system.

Note¹: Nuclear heavy water which has not been exposed to radiation.

The moderator purification system, in normal operation, without extraction of poison, ensures a normal purification for the corrosion products formed in the Main Moderator System, on the components made of stainless steel and zirconium alloy. The normal purification flow rate is passed through a mechanical filter with a 5µm mesh and a deionizer with ion exchanger resin, a half-life of approx. 8.30 hours. The determined activity for the specified radionuclides, except for noble gases (Na-24, Cr-51, Mn-56, Co-58, Fe-59, Co-60, Cu-64, Zn-65), at the exit of the purification system is below the detection limit. Thus, the operating efficiency of the moderator purification system (designed) in normal operation is achieved.

The primary heat transport agent purification system, in normal operation, to reduce the concentrations of impurities in heavy water, provides a combined filtration for the control of insoluble impurities (mechanical filtration with 2 µm mesh) and the use of ion exchange columns (in normal operation a deionizer with ion exchange resin is in service) for the control of soluble impurities and fission products (iodine). The normal purification flow rate provides a half-life of 1 hour necessary to reduce the concentration of impurities by half. The determined activity for radionuclides specified in the chemical operating documentation (Na-24, I-134, I-131, Co-60), except for the noble gases, at the output of the Primary Heat Transport purification system is below the detection limit. Thus, the operating efficiency of the primary heat transport (designed) system in normal operation is achieved.

Outputs from the LPCE system:

- *detritiated heavy water* (tritium content - 0,5 Ci / kg) which is collected from the base of the last catalytic isotope exchange column in a temporary storage vessel of processed heavy water with a maximum storage capacity of 3500 kg and which is transferred to the HWPS heavy water purification system, after which it returns to the U1 or U2 heavy water management systems, depending on the source of the heavy water;
- *tritium-enriched gas flow* (D₂ / DT / HD) which is collected at the top of the first isotope exchange column and which after a purification step (moisture retention and possible traces of oxygen and nitrogen), is transferred to the cryogenic distillation system.

2. Cryogenic distillation system - CDS (schematic flowchart is presented in Figure 1.2.2.3.2) constitutes the tritium concentration zone, the final "back-end" zone of the facility and has the following main elements:

- 4-column cryogenic distillation cascade, in which the separation and concentration of tritium from the gas phase takes place, and
- helium refrigeration unit, which has the role of cooling the condensers of the distillation columns.

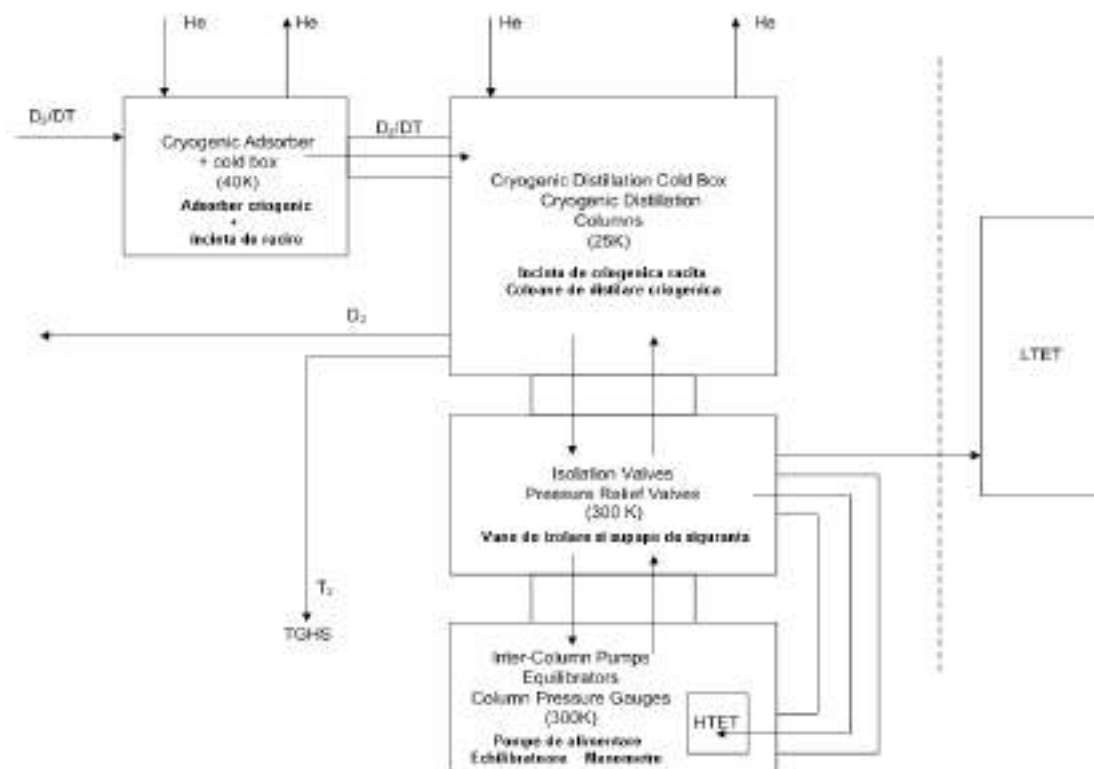

Figure 1.2.2.3.2 Schematic diagram of the cryogenic distillation system - CDS

Source: "Nuclearelectrica" S.A. National Society, Presentation Memorandum - Construction works for heavy water tritium removal facility, Variant for authorities - May 2019

CDS system inputs:

- D₂ / DT / HD gas flow

CDS system outputs:

- tritium gas, which is transferred to the handling and storage system
- deuterium gas, which is recirculated to LPCE

If it is necessary to empty the distillation system in a controlled manner or as a result of an incident/accident occurring during operation, expansion vessels have been provided for the entire inventory of gas in processing within the cryogenic distillation columns.

3. Tritium gas handling and storage system - TGHS (Figure 1.2.2.3.3), is located in a glove box, made of stainless steel and removable polycarbonate windows containing glove inlets and comprises the following main elements:

- a) the tank for measuring the specific activity of tritium from CDS;
- b) tritium storage containers on titanium bed (active and reserve) - Immobilized Tritium Container (ITC);
- c) uranium bed storage vessel used to clean the gas by adsorbing any other gas (deuterium and protium) generated as a result of abnormal operation. Abnormal operation refers to a quantitative presence of deuterium and protium (light hydrogen atom, whose nucleus consists of a single proton) in the tritium gas stream transferred to TGHS, which may be the result of an inefficient process of tritium separation in LCPE, respectively of tritium concentration in CDS;
- d) storage container transfer port.



Figure 1.2.2.3.3 WTRF-Korea tritium gas handling and storage system

Source: "Nuclearelectrica" SA National Society, Presentation Memorandum - Construction works for Heavy Water Tritium Removal Facility, Variant for authorities - May 2019

The analysis of tritium inventory in TGHSS must have an accuracy of $\pm 3\%$.

The Immobilized Tritium Containers are store in a room with concrete walls located in the basement of the CTRF building, ensuring the storage of ITCs resulting from the processing of heavy water in the CTRF. The tritium storage vault is an integral part of the building and is designed with a wall and ceiling thickness of approx. 1000 mm and floor thickness of approx. 1200 mm. The storage capacity is sized for the storage of all the resulting ITCs during the entire period of operation of the CTRF.

B. Operational support systems to ensure safety and maintenance in operation, as well as in the event of unplanned shutdowns or breakdowns [1].

- **Ventilation system - HVAC** aims to reduce the likelihood of explosion in the CTRF, to ensure air circulation between the CTRF radiological areas and to provide an adequate environment (ventilation and air conditioning) for the protection of personnel and the operation of equipment. The ventilation system comprises of 6 separate mechanical ventilation subsystems, respectively for the area of the hydrogen process systems, the area of the CTRF control room, the area of the battery room, the rooms of the compressors (helium and air) and the area occupied by process equipment without hydrogen.
- **Atmospheric tritium removal system** - The role of **ADS** is to reduce the concentration of tritium in the atmosphere of the rooms with, where tritium heavy water is transported and processed, when the tritium concentration in the air exceeds the established thresholds, in case of accidental leakage or damage. ADS uses a blower to make a negative pressure gradient in these rooms and ensures, by means of a catalytic recombinator, a recovery of tritium vapors, in order to keep the tritium concentration below the allowed limit, when evacuating the air to the installation stack.
- **Tritium retention system - TRS** it is of the stand-by type, it comes into operation at the time of maintenance, commissioning and unplanned shutdowns. TRS has the basic

function of recovering tritium and deuterium from the systems that process these gases and is equipped with dynamic equipment (pumps and blowers) and mechanical filters, 100% redundant.

- **Heavy water drainage and collection system** - The role of **LCS** is to manage the heavy water resulted when the installation is emptied, during periods of outage and maintenance operations, in order to be reused in the process or returned to the NPP systems, as the case may be. The LCS consists of a network of drain pipes from the equipment containing process water (LPCE, TRS and ADS) which is connected to a collector that supplies a 0.8 m³ tank located at the bottom of the drainage in the technological area of CTRF.

The tank is equipped with a water sampling point for the analysis of tritium and deuterium content, before being returned to the heavy water supply or product tanks, from the LPCE system, or to the active drainage system of the facility. Ventilation of the drainage and heavy water collection system is performed in the supply collector of the tritium retention system - TRS.

1.2.3 Structural components

1.2.3.1 Construction details

The construction of the CTRF is to be carried out based on the Site Approval and Construction Permit issued by CNCAN in accordance with the Norms regarding the authorization of nuclear installations, NSN-22, approved by the CNCAN President Order no. 336/2019 and with the Norm on the authorization of the execution of nuclear-specific constructions, NCN-01 approved by CNCAN President Order no. 407/2005.

The construction of the CTRF building, with a height of approximately 25 m, is a DBE (Design Basis Earthquake) and consists of:

Infrastructure: a C16 / 20 reinforced concrete foundation plate foundation and a 2-level basement, which will be a rigid structure with C30 / 37 reinforced concrete elements (walls, pillars, beams and floor).

Superstructure: tiered metal structure developed on 5 levels (ground floor, 3 levels and 1 partial level), with the resistance elements made of OL52.2k steel sections. The CTRF construction will be provided with 3 types of floors, arranged as follows:

1. For the basement area, reinforced concrete floors class C30 / 37 cast monolith;
2. For superstructure, reinforced concrete floors class C30 / 37 cast monolith with corrugated sheet metal formwork;
3. For the technological area, metal grate floors.

Exterior closures shall be made according to the degree of fire and explosion protection, either of brick, ROMPAN type panels or explosion panels.

In addition to the actual CTRF building, other facilities necessary for its operation will be located within the premises of the Project (Annex 1):

- Nitrogen tank platform;
- Helium tank;
- Deposits with inergen cylinders (inert gas for fire extinguishing);
- Oxygen cylinder storage;
- Helium cylinder storage;
- Dispersion stack;
- Stand-by Diesel generator group building;
- Medium voltage transformers,
- Instrument air compressors

The on-site traffic road will be developed as a concrete platform on the entire area.

In addition to roads, platforms and fences, the site provides technological networks, electrical cables and low currents, water supply and sewerage. The transfer of heavy water, demineralized water and active liquid drainage between the CTRF and the existing plant systems will be done through an external/above-ground route.

In Unit 1 and Unit 2, the service building, elevation 93.90 m, the system 38570 and the system 38580 will be connected to the heat systems (moderator / primary system, D₂O treatment system, D₂O supply system, etc.) and will have in the local configuration ion exchangers (additional filtration), tanks (buffer), D₂O transfer pumps and connecting pipes with related valves.

Positioning: the construction of the CTRF is on the site of Cernavoda NPP in the vicinity of Unit 1 and is limited by the slope to Saligny Hill and the main road inside the NPP that allows access from the PCA 1 gate to the Water Treatment Plant - STA.

Site organization

The organization of the site will be done in the vicinity of CTRF.

The existing concrete platforms will be used and, if necessary, any additional areas will be temporarily covered with a layer of 20 cm of ballast and another 10 cm of broken stone, to allow the access of mobile cranes and trucks during the works.

Where necessary, the sewers will be covered with wooden beams or metal plates embedded in the gravel layer.

The area of the sewer holes will be properly signaled by adjacent panels.

The excavated soil will be temporarily stored inside the NPP for verification of potential radioactive contamination. After verification, the intention is to reuse it as filling material.

The drainage of rainwater from the site organization area is done by portable drainage pumps located in the low points of the excavation and connected with flexible hoses to the rainwater drainage network of the Cernavoda NPP platform, in the immediate vicinity.

The organization of the site will include:

- **Access routes** - approved access routes;
- **Changing rooms;**
- **Drinking water supply, restroom** - according to the Cernavoda NPP procedures applicable to contractors (either the existing restrooms will be used or ecological toilets will be used);
- **Specific measures on occupational safety and security** - which involve the signing and implementation of a Labor Safety Convention as an integral part of service contracts to be engaged with future contractors.

1.2.3.2 Construction methods adopted

The construction works will be carried out in compliance with Law no. 111/1996 on the safe conduct, regulation, authorization and control of nuclear activities, with subsequent amendments and supplements, republished and CNCAN Order no. 72 / 30.05.2003 approving the CNCAN Norms regarding the specific requirements for the quality management systems applied to the construction-assembly activities intended for nuclear installations (NMC-08), as well as other applicable CNCAN Norms in conjunction with ISCIR nuclear prescriptions.

The classification of the constructions, systems and components of the Tritium removal facility that are important for security is made in security classes based on the security functions that they fulfill in accordance with the provisions of CNCAN Order no. 286 / 24.09.2004 (NMC 02).

The designer classified the building in the second degree of fire resistance, the fire hazard categories being "A" and "C" for the technological area, respectively "D" and "E" for the adjacent function area, in accordance with the provisions of the following regulations: NSN-09 CNCAN norms regarding the protection of nuclear power plants against fires and explosions; NP 099-04 / 2005 Norm for the design, execution, verification and operation of electrical installations in areas with danger of explosion; NEx 01-06 / 2007 Norm on explosion prevention for the design, installation, commissioning, use, repair and maintenance of technical installations operating in potentially explosive atmospheres; SR EN 60079-0 Explosive atmospheres - Part 0: Equipment. General Requirements (equivalent to IEC60079-0 ED.6.0 B COR.1: 2012); Canadian standard CSA N393: 13 Fire Protection for facilities that process, handle or store nuclear substances - 2018; NFPA 801/2008 * Standard for Fire Protection for Facilities Handling Radioactive Materials

2008; NFPA 2001 - 2008 Standard on Clean Agent Fire Extinguishing Systems 2008. Fire resistant construction materials 30 ÷ 180 minutes will be used, as appropriate.

For the evaluation of the foundation soil for the Heavy Water Tritium removal facility, an F1 drilling was carried out, and the results are presented in the Geotechnical Study which confirms the suitability of the location of the plant on this soil.

The foundation is made on the bedrock, by laying the basement of the building or by rigidly fixed piles. For the execution of the infrastructure, taking into account the need to protect the existing constructions, trestle, cable ducts, etc., the excavation will be carried out in a closed enclosure, of Berlin support type [1].

1.2.3.3 Permanently and temporarily occupied land area

The land on which the CTRF installation is being built is free of construction, with no demolition required. The surface of the land related to the CTRF installation is approx. 1350 sqm and divided according to table 1.2.3.3.1.

Table 1.2.3.3.1 Expected territorial balance for the CTRF objective

Category	Area (sqm)	Occupancy rate (%)
Total land area	1350	100
Built area	591	44
Estimated land area to be occupied temporary (site organization)	50	4

1.2.3.4 Land areas occupied by each of the permanent components of the project

In figure 1.2.3.4.1. the permanent components of the CTRF project site are quantified and indicated (including associated access roads, landscaping and auxiliary facilities).

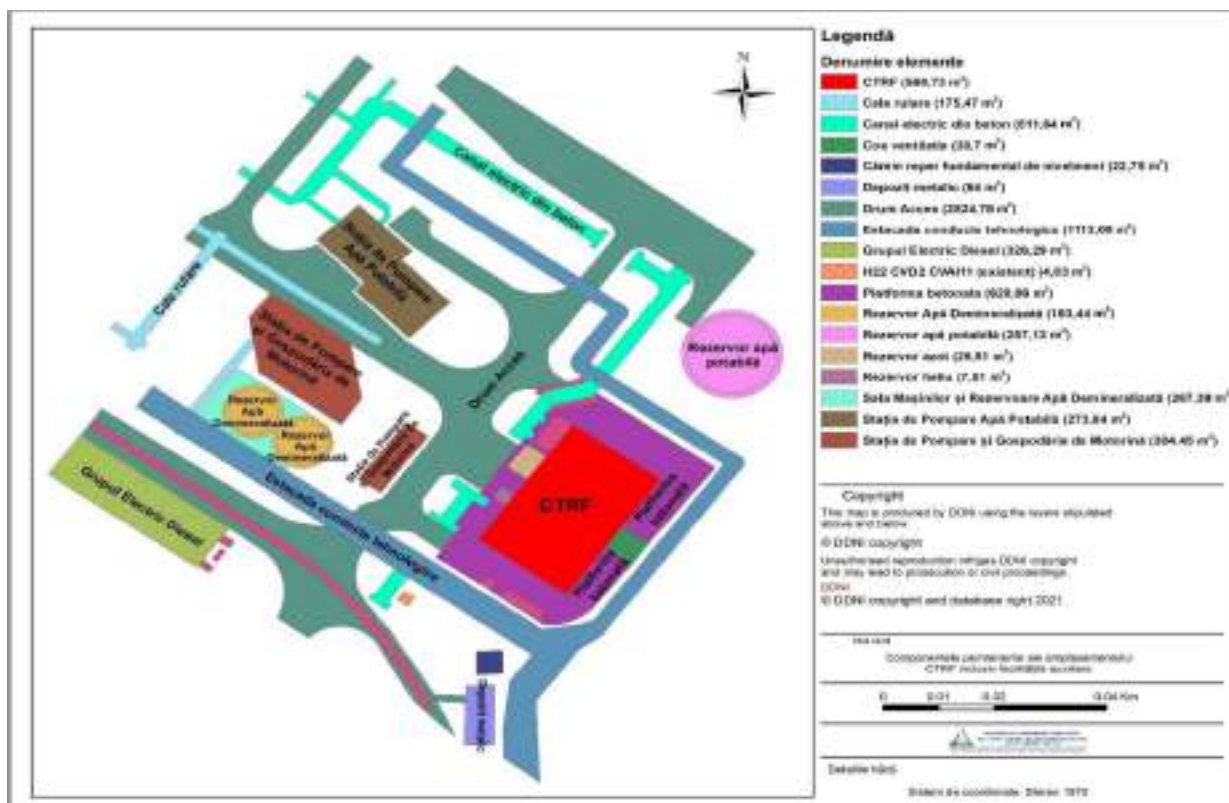

Figure 1.2.3.4.1 Map of land areas occupied by each of the permanent components of the CTRF project

1.2.4 Emissions

Potential dust emissions caused by soil excavation and the temporary location of excavated soil for fillings will be generated during construction. There is also the possibility of potential dust emissions during transport / evacuation operations.

Another possible source of dust is the transport of raw materials used for construction work. This category includes small-grained materials (sand).

Also, during the construction phase potential emissions will be generated from the burning of fossil fuels, used by the engines of the machinery / equipment that will be working on site.

1.2.5 Types and quantities of chemicals used

At this stage of the project, it is not possible to estimate the quantities of chemicals that will be used in the construction phase. Hydrocarbons (diesel, engine oils, lubricants), paints and solvents are expected to be used from the chemical category in the construction stage. It is expected that the chemicals used in the construction phase, will be hydrocarbons (diesel, engine oils, lubricants), paints and solvents.

In carrying out the project as well as subsequently in the current activity of the CTRF, it is estimated that chemical substances and preparations classified as hazardous will be used, such as those presented in Table 1.2.5.1.

Table 1.2.5.1 Types and quantities of chemicals used during construction

Chemicals used	Amount
Equipment cleaning products (avesta paste)	The quantities will be defined by the Contractor of the work
Degreasing solvents	The quantities will be defined by the Contractor of the work
Coating mixtures (primer, paint)	The quantities will be defined by the Contractor of the work
Lubricants (oils and Vaseline)	The quantities will be defined by the Contractor of the work
Fuel (Diesel)	Estimated 4000 t

During the construction phase, the chemicals will be used in small quantities on the CTRF site, and the remaining quantities of chemicals will be stored in the specially designed spaces of Cernavoda NPP, respecting the NPP procedures for storage and record of consumption.

Management of hazardous chemicals and solutions shall be carried out only in accordance with their Safety Data Sheets drawn up in accordance with Regulation (EC) no. 1907/2006 of the European Parliament and of the Council of 18 December 2006 on the Registration, Evaluation, Authorization and Restriction of Chemicals (REACH) and on the requirements for listing chemicals approved for use in the Cernavoda NPP. Only chemicals that comply with the requirements for classification, packaging and labeling in accordance with Regulation (EC) No 1272/2008 shall be accepted for use.

All chemicals, except those delivered in bulk (for example: diesel) will be stored in the manufacturer's packaging, with the integrity and tightness of the packaging checked in temporary storage facilities and taken over for use; the packaging and labeling being mandatory in accordance with the legal provisions in force. In order to avoid multiple releases from storage (sealing / unsealing of manufacturers' containers until the whole quantity is used), the optimum volume of a container shall be indicated as far as possible, depending on the actual quantities required during the works for a chemical used in quantities smaller than the volume of the package in which it was delivered.

The diesel required for the CTRF Stand-by Diesel generator groups is discharged directly from the tanks into the special storage tanks on the CTRF site according to the NPP procedures.

The gases will be delivered in containers specific to the respective product type, labeled and sealed, according to ISCIR prescriptions and regulations regarding pressure vessels [18].

Substances with potential for oxidation, explosion and flammability, respectively oxygen, hydrogen (up to 300 Nm³ isomers in the installation) and diesel will be on the site of the CTRF in quantities less than 2% compared to the relevant quantities for the classification of lower-level sites.

The biocidal products will be accompanied by the Approvals given by the Ministry of Health in accordance with the provisions of GD no. 617/2014 on the establishment of the institutional framework and measures for the implementation of Regulation (EU) no. 528/2013 of the European Parliament and of the Council of 22 May 2012 concerning the making available on the market and use of biocidal products, with subsequent amendments and additions.

Personnel handling, storing, transporting and using chemicals shall be trained for these activities in accordance with occupational safety and fire protection regulations and will always wear appropriate personal protective equipment.

1.2.6 Generated waste and wastes management

In the construction / assembly stage of the CTRF installation, mainly inert waste will be generated. Most wastes with recovery potential (Table 1.2.6.1). Waste without potential for recovery will be disposed of. The Responsibility for good waste management is transferred by detailing the requirements of the Environmental Permit and other permits, approvals, etc. under the contract of execution and its annexes (Environmental Protection Convention, etc.).

Table 1.2.6.1 Main types of waste that may be generated during the construction / assembly of the CTRF installation

Types of waste	Description	Waste code	Management mode	
			Recovery	Eliminated
Soil and stones, other than those mentioned in 17 05 03 *	Soil and stones from excavations	17 05 04		x
Concrete	Simple concrete	17 01 01		x
Mixtures of concrete, bricks, tiles and ceramic materials other than those mentioned in 17 01 06	Concrete / bricks / slabs (mixed, non-hazardous)	17 01 07		x
Mixed municipal waste	Household waste - office area	20 03 01		x
	Household waste - Pre-assembly area + work staff			x
Iron and steel	Structural steel elements and HVAC units	17 04 05	x	
	Stainless steel pipes for project networks		x	
Metal mixtures	Metal grid	17 04 07	x	
	Waste from scaffolding		x	
	Welding electrodes and fasteners		x	
	Metal scrap from plate elements (corrugated iron)		x	

Soil and stones containing dangerous substances	Contaminated soil (accidental oil / diesel spills, etc.)	17 05 03 *		x
Paper and cardboard	Waste paper and cardboard - Office area	20 01 01	x	
	Paper and cardboard waste - Pre-assembly area + work staff		x	
Plastic materials	Plastics resulting from office and pre-assembly areas	20 01 39	X	
Construction and demolition plastics	Plastic elements and plastic pipes	17 02 03	x	
Packaging that contains residues or is contaminated with hazardous substances	Contaminated packaging (non-radioactive)	15 01 10 *		x
Absorbents, filter materials (including oil filters not otherwise specified), filter materials polishing, protective clothing contaminated with hazardous substances	Absorbents, filter materials (polishing materials, protective clothing contaminated with dangerous substances)	15 02 02 *		x
Glass	Glass waste - results from office and pre-assembly areas	20 01 02	x	
Metals	Metal elements resulting from office and pre-assembly areas	20 01 40	x	
Wooden packaging	Packaging waste - Wood	15 01 03	x	
Plastic packaging	Packaging waste - plastic	15 01 02	x	
Composite packaging	Composite packaging materials	15 01 05	x	

Note: 1. The above codes for waste are estimated, the classification being made when they are generated in accordance with the applicable legal requirements.

The organization responsible for the site will develop its own waste management plan that will include the necessary measures for the collection and proper storage of non-radioactive industrial waste generated during the project, according to the legal provisions in force and the NPP procedures.

Thus, non-radioactive waste will be managed in accordance with the following procedures:

- RD-01364-Q10 - Environmental management at Cernavoda NPP;
- Instruction SI-01365-A033 - Non-radioactive waste management at Cernavoda NPP;
- Instruction SI-01365-P022 - Order and cleanliness at NPP;
- Process specific procedure PSP-Q010-005 - Non-radioactive industrial waste management at Cernavoda NPP;
- Process specific procedure PSP-A001-006 - Carrying out operations with restricted explosive precursors within Cernavoda NPP;
- Process specific procedure PSP-Q010-007 - Method of administration of chemicals with special regime within Cernavoda NPP;
- IDP-SAD-005 procedure - Classification, collection, transport, temporary storage and shipment of hazardous and non-hazardous waste.

1.2.7 Natural resources, raw materials and energy required to carry out the project

Natural resources and raw materials

A series of natural resources and raw materials will be used to carry out the project, presented in table 1.2.7.1.

Table 1.2.7.1. Natural resources and raw materials used in the project

Category	Estimated quantity (tonnes)
Natural Resources	
River stone / broken stone	490
Sand	226
Soil (land on which the building is located)	6000
Water	400
Raw materials	
Reinforced concrete	7,049
Steel (structural, reinforcements and grilles)	1,100
Metal pipes	35
HDPE pipes (plastic)	10

Energy

During the construction phase of the CTRF installation, the power supply will be provided from the Cernavoda NPP's own network.

Natural resources management

The management of natural resources and raw materials, necessary for the construction stage will be done according to the applicable legal provisions in force and to the Cernavoda NPP procedures in order to maximize the use of these resources and to minimize the resulting waste quantities. Thus, materials will be stored and protected in accordance with the manufacturer's recommendations. Weather-sensitive materials will be covered with tarpaulins or waterproof covers and will be provided with an adequate ventilation system to prevent condensation.

1.2.8 Tools, equipment and other means necessary to be used

In the construction / assembly stages, there will be used tools, equipment, machines and other means such as [1]:

- trucks for the supply of raw materials and products, respectively for the evacuation of construction waste, or moving machinery and equipment;
- concrete mixers;
- 1-2 bulldozers, 1-2 excavators, 2-3 mobile cranes; pneumatic hammers, welding machines (electric and oxyacetylene arc), shovels, metal scaffolding, etc.

1.2.9 Route, horizontal and vertical alignments, excavations and earthworks

The linear works executed for the construction of CTRF include both underground and above-ground routes. For the underground routes, the excavations will be made with vertical slopes (where applicable), and the support of the excavation will be dimensioned according to its depth and opening, respecting the requirements of the Norm on the requirements for design, execution and monitoring of deep excavations in urban areas – “NP 120-2014”.

The category of linear works requiring excavations includes the following:

Drinking water supply system which will be connected to the existing network of the plant through a valve manhole (CV5). The route of the drinking water supply network is approximately 30 meters and starts from the immediate vicinity of the CTRF to the connection point located in the vicinity of Unit 1. The pipeline made of HDPE PE 100 Dext. 63 x 2.5 mm, SDR 26, Pn 6, will be installed below the frost depth (Appendix 1).

CTRF sewer system will be gravitational connected to an external connection made in a separate system, in the existing U1 sewerage network on the Cernavoda NPP platform, in the immediate vicinity of the site. For the external sewer the pipeline will be made of HDPE, class PE 80, SDR 17.6 with Dext. 90 x 5.1 mm, according to SR ISO 161-1: 2008, VALROM type or equivalent, will have elastomer sockets and gaskets and a route of approximately 50m and will be provided with a manhole DN 1000 of HDPE, Kessel type (Annex 1).

Rainwater drainage system is made up of a collector channel, made of polyvinyl chloride tubes - PVC, class SN8, with Dn 160 mm for external sewerage, with plugs and gaskets made of elastomers. The route of this collector channel located in the immediate vicinity of the new CTRF building, is of approx. 50 m, having the point of unloading in the existing drainage sewer on the Cernavoda NPP platform (Annex 1).

Water supply for fire extinguishing of the CTRF installation will be performed by means of a HDPE PE 100 pipe with Dext. 75x6.8 mm, SDR 11, PN 16, according to SR ISO 161-1:2008, which will be linked by a connection to the water supply system for extinguishing fires of the Cernavoda NPP platform. The route of this system will be of approximately 20 meters and will start from the vicinity of the CTRF to the connection point located in the vicinity of the CTRF Depot - Oxygen and helium cylinders (Annex 1).

The category of linear works that do not require excavations includes tritiated / detritiated heavy water transport system and the radioactive liquid waste system on the route between CTRF and Units 1 and 2. The pipes in the tritiated / detritiated heavy water transport system and in the radioactive liquid waste system will be made of nuclear grade stainless steel, which will be placed on reinforced concrete supports in compliance with the characteristics imposed by the regulations in the field, including seismic qualification (Annex 1).

Excavations and earthworks

For the construction of the CTRF foundation, excavations on a length of 40 m and a width of 25 m will be required. The depth of the excavations will be approximately 11.00 m - 12.00 m. Due to the great depth and the lack of workspace, there will be vertical walls that must be supported to ensure the safety of the works, the personnel as well as the protection of the existing constructions (pipe bridge, explosion-proof wall, cable ducts, etc.).

For the construction of the Drinking Water Supply System, the Domestic Sewerage System, the Rainwater Sewerage System and the Fire Supply of the CTRF installation, earthworks will be carried out in limited spaces for hard ground pipes. The filling will be made with a 15 cm sand substrate and a 30 cm coating, and the pressing of the fillings will be done with the handheld compactor, in layers of 10 cm thickness.

1.2.10 Demolishing activities required for project implementation

No demolishing work is required in order to carry out the CTRF project. The land on which the CTRF installation is being built is free of construction, with no demolition required.

1.2.11 Installations / Constructions required for the project

Other installations / constructions necessary for the operation of the heavy water tritium removal installation will be located both inside and outside the CTRF premises, namely [6]:

Liquid nitrogen tank will be located on a reinforced concrete platform, with an area of 6.00 m x 4.00 m.

The helium cylinder storage will be located on reinforced concrete platform, with an area of 2.5 m x 2.5 m.

Oxygen cylinder storage will be provided with natural ventilation and fireproof material floor and will ensure the storage of 16 oxygen cylinders.

Oxygen and helium cylinder storage building will be connected to the CTRF building by the helium distributor collector which will be located on the new CTRF pipe trestle (2) and on the existing CTRF trestle (1). The helium distributor collector and the distribution pipes will be designed, executed and installed by the Unit responsible for these activities within the CTRF, selected by Cernavoda NPP.

Helium supply system will be located in the building of the oxygen and helium cylinder storage with an area of 16 m² with sides of 4.00 m x 4.00 m and a maximum height of 3 m. The ventilation of this storage will be done naturally.

Inergen cylinder Store (inert gas for fire extinguishing) will include a number of 30 active cylinders and a number of 30 backup cylinders.

Dispersion stack will be supported on a foundation with an area of approx. 25 m² and will have a height of 50 m and a diameter of 1,700 mm. The dispersion stack will have an evacuation capacity of 103,000 m³ / hour [7, 17].

Two electrical transformers of medium voltage 6 / 0.4kV will be located near the CTRF building on a concrete platform.

Stand-by Diesel generator groups building will be made of light structure, with an area of 80 m², with a height of 4 m (10 x 8 x 4m). It will have 2 identical rooms (DG) of 28 m² each (7 x 4 x 4 m), which will be separated by a wall to ensure separation and fire protection. There will be 2 buffer chambers measuring 4x1 (1.5) m each that will make the connection between the DG and the fuel transfer pump chamber in the fuel tank. Another 2 rooms with an area of 12 m² each (4x3x4 m) will be designed for the transfer pump and the fuel tank.

Fluids belonging to the following systems are conveyed through the pipes located on the CTRF pipe bridge:

- Heavy Water Feed System (HWFS);
- Heavy Water Product System (HWPS);
- Demineralized water supply system;
- Active drainage system.

External connections

CTRF will be connected to the rainwater (meteoric) sewerage, domestic water sewerage, demineralized water supply, drinking water supply, fire water supply utilities, through an external utilities connection [6].

The stormwater from CTRF will be collected (via collection slopes), transported and discharged in the existing stormwater sewer network on the platform [6].

Sewage from the objective will be collected, transported and discharged through a separate system in the existing sewer network on the platform [6].

The water flow required for the drinking water supply will be provided through a connection to the existing drinking water supply network on the platform [6].

The demineralized water flow required for the initial inventory and the completion of losses from the cooling water system and the chilled water system will be provided through a connection in the demineralized water supply system coming from STA.

The water required to supply the CTRF building with fire-fighting water will be taken over through a connection from the existing fire-fighting water supply network on the platform [6].

The roadway will be provided as a concrete platform over the entire surface [1].

In addition to roads, platforms and fences, the site provides technological networks, electrical cables and low currents, water supply and sewerage [6].

1.2.12 Further developments that may occur as a result of the project

Existing access routes will be used. The roadway inside the CTRF installation will be provided as a concrete platform, on the entire surface. The road structure of the roadway will consist of ballast, crushed stone, sand, kraft paper or polyethylene foil and concrete pavement [1].

1.2.13 Existing activities that will be modified or changed as a consequence of the project

Following the implementation of the CTRF project, a series of existing activities on the Cernavoda NPP site will undergo changes, as follows:

- The water supply will require changes caused by the connection of the networks:
 - Water supply for hygienic - sanitary purposes
 - Process water supply
 - Water supply for extinguishing fires
- Domestic and rainwater drainage systems;
- Power supply;
- Modification of the existing pipe bridge by adding additional supports for CTRF technology pipelines. Also, two new pipe bridge (pipe bridge 1 and 2) will be built, which will be connected to the existing pipe bridge, according to the plan legend in Annex 1. The two new pipe bridge will support the CTRF pipes - heavy water supply (HWFS), heavy water product (HWPS), demineralized water supply, active drainage, oxygen supply and helium supply (pipe bridge 1). Oxygen supply pipes and helium supply pipes will be located on pipe bridge 2. The existing pipe bridge, the new pipe bridge, and additional supports are DBE qualified.

1.2.14 Relationship with other existing or future projects

A. Similar technological projects

Heavy water tritium removal plants are currently in operation in Darlington - Canada (DTRF) and Wolsong Korea (WTRF).

Darlington (DTRF)

Darlington Tritium Removal Facility (DTRF) was designed and built by Sulzer Canada Inc. for Ontario Hydro. DTRF has been operated by Ontario Power Generation since 1996, processing heavy water from the 20 CANDU units operating in Ontario, Canada. The plant uses a vapor phase catalytic exchange (VPCE) process combined with CD to separate tritium from deuterium. Separated tritium is stored as titanium hydride (tritride) in an immobilized tritium (ITC) container and stored in a specially designed room. The process met the design requirements for tritium removal and tritium purity with reliable tritium handling and accurate inventory management.

Moderator activity decreased from an average OPG (Ontario Power Generation) reactor unit of 23 Ci / kg heavy water in 1989 to about 9 Ci / kg in 2012 (~ 60% decrease). Tritium emissions and internal doses to workers showed similar reductions.

Wolsung (WTRF)

Wolsung Tritium Removal Facility (WTRF) was designed by AECL, Kinectrics Inc. and Korean partners and commissioned by Korea Hydro & Nuclear Power Company, being in operation since 2007. WTRF uses a Liquid Phase Catalytic Exchange (LPCE) / CD system, which is the same process system as CTRF. LPCE uses less energy than a VPCE system because it operates at approx. 70°C, without the need to evaporate heavy water.

The Wolsung - Korea (WTRF) tritium removal plant is designed to process 100 kg / hour of tritiated water with a tritium extraction efficiency > 97%, with an operating capacity of 80% and a lifespan of 40 years. This installation is technologically similar to the installation to be carried out at Cernavoda, applying the same processes for LPCE isotopic exchange, CDS cryogenic distillation and immobilization in titanium storage tanks TGHSS Tritium Gas Handling and Storage System.

The activity of the Wolsung U1 moderator decreased from 62.7 Ci / kg to 0.25 Ci / kg in 4 years due to the operation of WTRF. For U2, the activity of the moderator decreased from 48.3 Ci / kg to 5.5 Ci / kg in 3 years. Tritium emissions from U1 have been reduced by 85% in 6 years for U1. For U2, the reduction was 70% until 2012.

The above two units are the only industrial units for the removal of tritium from tritiated heavy water, which currently operates worldwide. Of these two industrial-scale installations, as mentioned above, the CTRF project is largely similar to the WTRF project in terms of technological process [24].

The CTRF installation project was developed under the coordination of the National Research-Development Institute for Cryogenic and Isotopic Technologies Râmnicu Vâlcea (ICSI Rm. Vâlcea), starting with 2008. ICSI Rm. Vâlcea carried out several projects within the institute that materialized by carrying out an experimental tritium removal plant (Experimental Pilot for Tritium and Deuterium Separation - PESTD) to confirm the technological data and functional characteristics of specific materials and equipment, in order to use them for the design of the heavy water tritium removal plant used in CANDU reactors.

The Pilot PESTD Installation is currently associated with EURATOM / JET (Joint European Torus) programs as a facility for studies and experiments specific to fusion reactor tritium removal facilities and is also involved in the development of projects for the ITER reactor from Cadarache, France.[1].

B. Relevant existing or future projects on the site of Cernavoda NPP

On the Cernavoda NPP platform, a series of projects are carried out which are intended to ensure the smooth and safe development of the existing activities of Units U1 and U2, respectively the implementation of future projects that aim at the safe continuation and development of nuclear activities on the platform, ensuring the protection of workers, the population and the environment.

Table 1.2.14.1 presents the existing or future projects considered relevant to the Project, in terms of estimating the cumulative environmental impact.

Table 1.2.14.1 Relevant existing or future projects on the Cernavoda NPP site

Project title	Type of project	Distance from CTRF project site	Project stage / destination
Intermediate Storage Facility for Spent Fuel (DICA) based on construction staged by MACSTOR 200 modules (DICA area: 24,000 sqm)	Existing project integrated into the Cernavoda NPP platform units U1 and U2	Approx. 800 m	DICA was put into operation in 2003 (Environmental Agreement no. 2058 / 22.02.2002 issued by the Constanța Environmental Protection Inspectorate). The technological solution of the existing DICA project was to store spent nuclear fuel in MACSTOR 200 type concrete modules.

			DICA is integrated in the approved environmental permit of the Cernavoda NPP by GD no.84 / 2019.
Refurbishment of Unit 1 of Cernavoda NPP and Extension of the Intermediate Storage Facility for Spent Fuel with MACSTOR 400 Modules (DICA area expanded 40,000 sqm)	project upcoming	Approx. 200 m, respectively 800 m	Future project that was notified to MMAP, for the initiation of a procedure for issuing the environmental agreement. In this procedure MMAP issued the Decision of the initial evaluation stage no. DEICP / 15817 / 19.10.2020. The project will also fall under the Espoo Convention.
Continuation of the works of construction and completion of Units 3 and 4 at NPP Cernavoda	Future Project	Approx. 400, respectively 500 m	The U3 and U4 Units will be built on the Cernavoda NPP platform, a project for which the Environmental Permit was issued by GD no. 737/2013.
Works necessary to change the destination of the existing constructions on the site of Unit 5 from nuclear power plant to other useful support objectives during the life of the NPP Units	Completion 2024	Approx. 800 m	Environmental agreement no.983RP / 08.11.2016.

1.2.15 Associated / auxiliary works that are excluded from the evaluation

The evaluation covers all works associated with the CTRF project.

1.2.16 Restoration work on the site in the area affected by the execution of the investment

The execution of the project does not require ecological reconstruction works, the location being in the industrial area, inside the Cernavoda NPP.

1.2.17 The size of any structures and other development works as part of the project

The size of any structures and other development works as part of the project is presented in subchapter 1.2.3.1.

1.2.18 Stage of technological tests and commissioning

The commissioning of the CTRF installation will be carried out in accordance with NSN-22 "Rules regarding the authorization of nuclear installations, approved by CNCAN President Order no. 336 / 03.01.2019 and in accordance with the provisions of the Final Nuclear Safety Report. [1].

The planned tests will follow the fulfillment of the following objectives:

- ensuring that the equipment has been made and installed according to the project;
- ensuring that the CTRF system performance requirements are met and validating safety assumptions;
- familiarization of CTRF personnel with the operation of the installation (training and certification of operating and maintenance personnel according to the regulations in force);
- approval of the operating procedures of the installation.

The CTRF commissioning plan will reflect relevant industry practices and use operating experience (OPEX) at the Wolsong Tritium removal facility (WTRF Korea).

The commissioning plan for the CTRF installation will be made in conjunction with the importance of structures, systems, equipment and components, classified as important for nuclear safety, according to CNCAN Standards applicable, as listed in the licensing bases (LBD), a document approved by CNCAN. The policy documents and the programmatic documents describing the objectives and the policy of the commissioning organization will be submitted and sent for

approval to the national regulatory authority in the Nuclear power field, CNCAN being the subject of the corresponding revision of the Integrated Management Manual of Cernavoda NPP.

The CTRF commissioning program will identify five steps specific to the verification / inspection stages at industrial installations, in a logical sequence, as follows [1]:

- *Step 1: Pre-Hydrogen* - includes the activities necessary for the general verification of the construction and ensuring the safety requirements, prior to the introduction of the hydrogen (deuterium) inventory in the installation.
- *Step 2: Deuterium testing* - involves filling the process systems with deuterium in order to confirm the operation of all hydrogen safety equipment in accordance with the design specifications.
- *Step 3: D₂O testing* - involves the introduction of heavy water (D₂O) into tritium removal equipment in order to confirm the operation of major CTRF systems in accordance with the design specifications.
- *Step 4: Low concentration tritium testing* - involves the introduction of tritiated heavy water (DTO) with a low concentration of tritium in the plant and aims to demonstrate effective tritium removal at low concentrations.
- *Step 5: High concentration tritium testing* - Heavy water with a high concentration of tritium is gradually added. The higher tritium concentration will demonstrate the achievement of the tritium removal factors and the processing rates provided in the project. Also, the compliance with the limits and operating conditions will be demonstrated, as well as the observance of the safety objectives for the CTRF installation.

At the end of a stage, the transition to the next stage will be made only after the successful completion of the previous sequence and only after obtaining the CNCAN authorization that is issued for each stage. Prior to declaring the CTRF operational, a performance test shall be taken to ensure the following [1]:

- The commissioning of the equipment was carried out in accordance with the documented procedures, with qualified and trained personnel;
- All operating parameters meet the specified criteria;
- All deficiencies have been identified and resolved;
- The analysis of the completion of the commissioning steps was carried out in accordance with the pre-established requirements.

The performance verification test will be taken as part of Stage 5. Thus, the corresponding provisions of the Norms on the requirements for the quality management system applied at commissioning will be applied, assimilated in the quality assurance policy of Cernavoda NPP.

All tests shall be performed in accordance with the test procedures and documentation developed for commissioning. The results of the performance test will be included in the Completion Report. All the procedures that will be developed for the commissioning of the CTRF installation will be integrated in the specific processes described in the Integrated Management System Manual of Cernavoda NPP, approved by CNCAN.

As part of the commissioning program, the organization responsible for commissioning will inform the National Commission for Nuclear Activities Control on the planning of commissioning activities and the stage of their fulfillment.

1.3 Main features of the operation stage of the project

1.3.1 Description of the plant and technological flows

The technological flow of the CTRF installation is shown in the Block diagram of the installation (Figure 1.3.1.1).

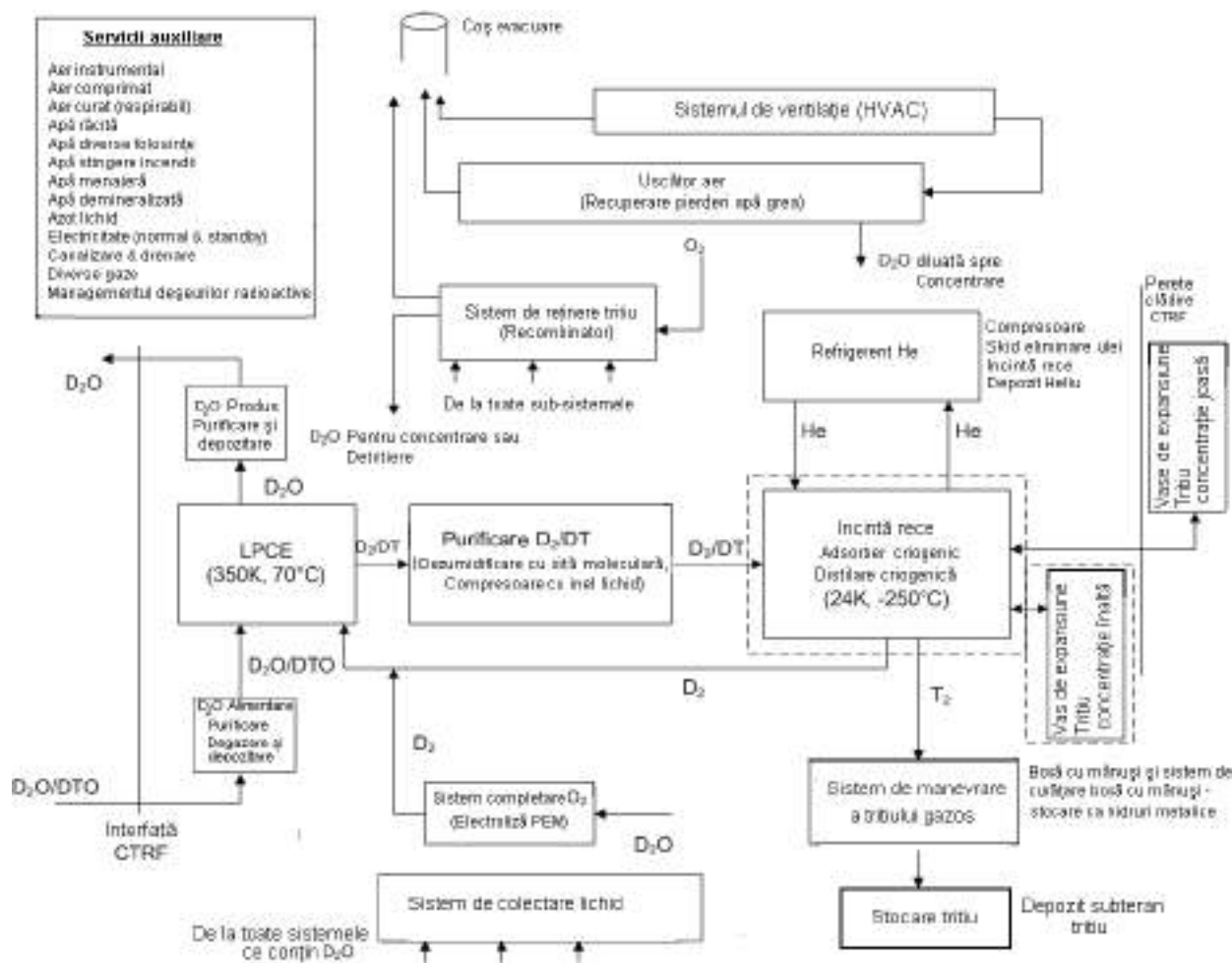

Figure 1.3.1.1 CTRF block diagram

Source: "Nuclearelectrica" SA National Society, Presentation Memorandum - Construction works for Heavy Water Tritium Removal Facility, Variant for authorities - May 2019

The technological flow of the Project includes the following main processes [1]:

Storage, purification and transfer of tritiated heavy water from reactor-associated systems for supplying CTRF

- Tritiated heavy water from reactor-associated systems may contain mechanical impurities and dissolved chemicals (including active beta-gamma impurities, mainly due to the activation of corrosion products), and their removal is necessary for the operation of catalytic columns.
- This purification is planned to be carried out in the tritiated heavy water supply system of the installation (HWFS - Heavy Water Feed System) which contains 2 tanks of 3 m³ each and two columns with ion exchangers, which ensure heavy water at the quality level required for feeding isotope exchange columns, LPCE.
- For the continuous operation and separate management of the heavy water inventory from U1 and U2, 2 similar HWFS installations have been provided, one for each unit, which is located in the service building of the respective units. The flow diagrams of the system of this process are presented separately for U1 and U2 in the figures 1.3.1.2 - 1.3.1.3.

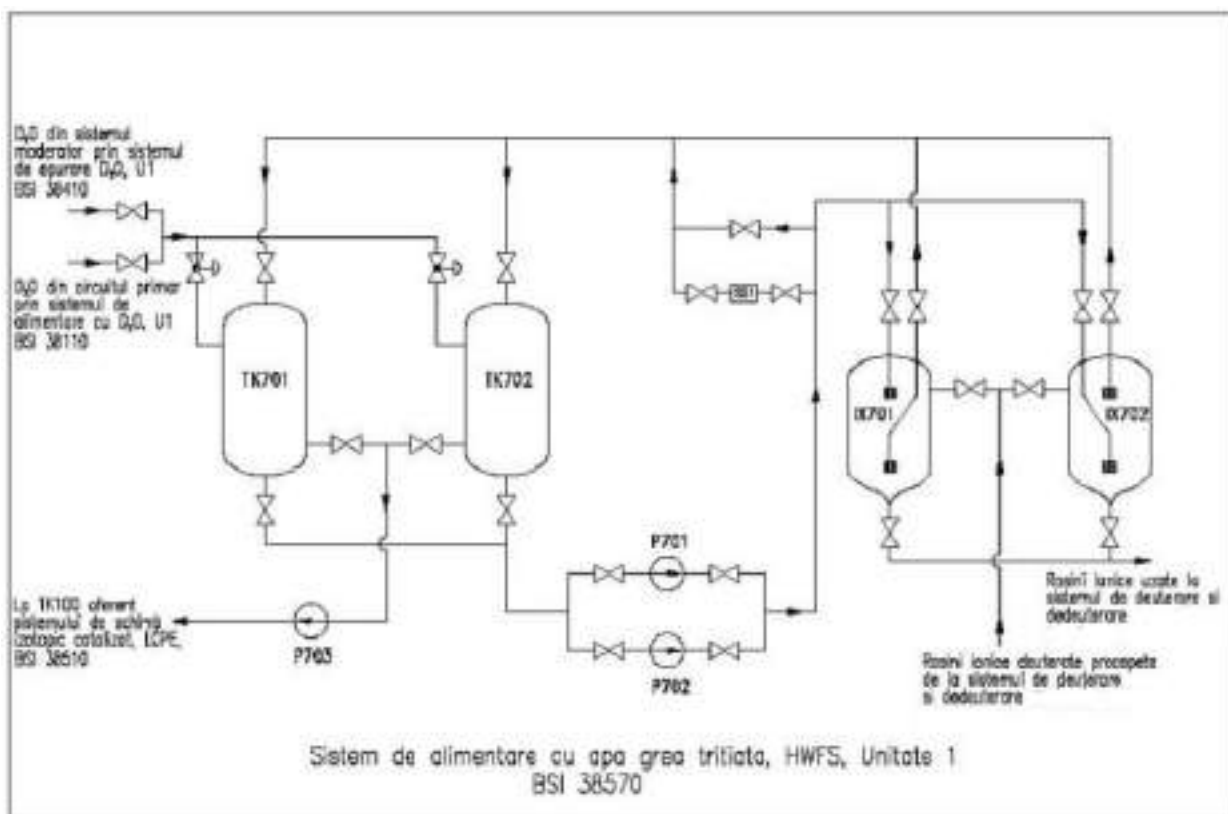

Figure 1.3.1.2 HWFS Tritiated Heavy Water Feed System (Unit 1)

Source: "Nuclearelectrica" SA National Society, Presentation Memorandum - Construction works for Heavy Water Tritium Removal Facility, Variant for authorities - May 2019

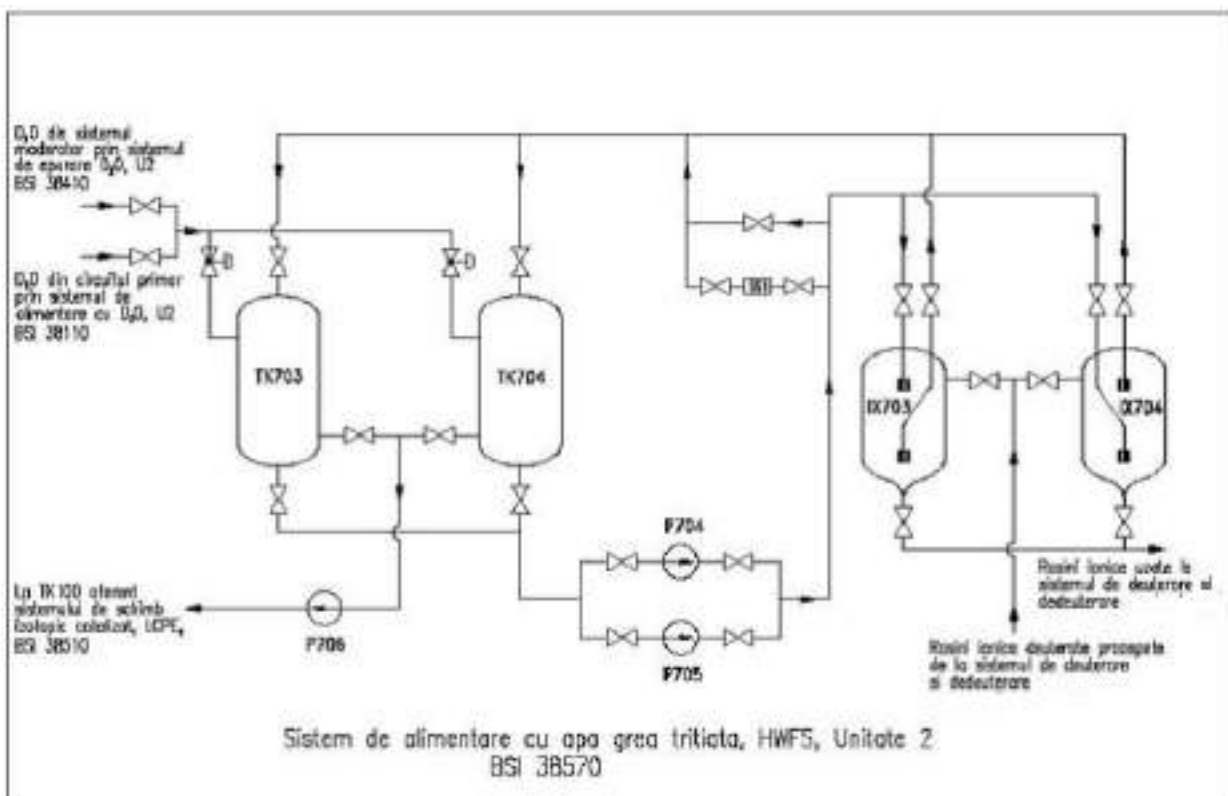

Figure 1.3.1.3 HWFS Tritiated Heavy Water Feed System (Unit 2)

Source: "Nuclearelectrica" SA National Society, Presentation Memorandum - Construction works for Heavy Water Tritium Removal Facility, Variant for authorities - May 2019

The system allows the quality control of the heavy water in the tanks during the purification operation, through the possibility of sampling.

The supply of CTRF with tritiated heavy water from HWFS tanks is done through a system of stainless steel pipes, pipe-in-pipe type, under the following conditions:

- 3000 kg of heavy tritiated water in campaigns;
- Each campaign is divided into tranches of 1000 kg of heavy tritiated water which is transferred to the supply tank of the next main system (LPCE);
- Tritium concentration of moderator heavy water when supplying the CTRF installation - max. 54 Ci / kg. For higher values of tritium concentration, in the first months of operation of the plant, its reduction will be achieved by dilution with heavy water with low tritium concentration;
- The supply is made by ensuring a flow rate of 40 kg / h.

The entire tritiated heavy water supply route from the U1 / U2 units to the CTRF is provided with a heating system to avoid freezing and is also online monitored in order to detect in real time any accidental fluid leakage along the way and to take the necessary measures to prevent such leakage.

Catalytic isotope exchange - LPCE that ensures the transfer of tritium from liquid phase (DTO) to gas phase (DT / HD / D2)

The tritium transfer process takes place in LPCE columns, in which the tritiated heavy water from HWFS flows in countercurrent with an upward flow of D₂ heated to 70°C, in the presence of a catalytic filler, having two components, a hydrophilic filler and a hydrophobic catalyst.

In fact, the transfer of tritium from heavy water to deuterium gas is the result of combining a classical process of water distillation (1) in the presence of hydrophilic packing with the isotope exchange reaction (2) in the presence of hydrophobic catalyst, as follows:

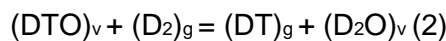
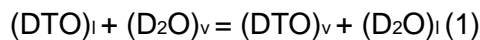

Where: (DTO)_l - tritiated heavy water in liquid phase;
(DTO)_v - tritiated heavy water in the vapor phase;
(D₂O)_l - virgin heavy water in liquid phase;
(D₂O)_v - virgin heavy water in the vapor phase;
(D₂)_g - deuterium gas;
(DT)_g - deuterium tritiated gas.

The hydrophobic catalyst rejects liquid water, but allows both heavy water vapor and deuterium gas to reach the active catalytic centers and accelerate the isotopic transfer process.

Worldwide, several types of catalysts have been developed and used in industrial installations, pilot stations, or tested only in the laboratory, with comparable performance on isotopic transfer coefficients and wettability (water adhesion to the surface of hydrophilic filler and respectively hydrophobic catalyst), some of which are presented below:

- Mixed catalytic filler in a single layer, developed by ICSI Rm. Vâlcea comprises a packing of profiled strips made of hydrophilic metal mesh (stainless steel), arranged in the form of cylindrical packages and the hydrophobic catalyst, in the form of platinum pellets deposited on carbon and polytetrafluoroethylene - Teflon (Pt / C / PTFE), inserted between metal strips. The mixed catalytic packing packages have a height of 100 mm and a diameter of 302 mm, in order to ensure both the best possible filling of the columns and the possibility of their introduction and removal from the column.

- the similar variant of mixed catalytic packing is the structured packing developed by AECL (Canada), which alternates between hydrophilic stainless-steel strips (plates) with identical strips covered with a thin layer of platinum catalyst on coal and Teflon.
- another potential solution for the LPCE catalyst is the one used at the Wolsong tritium removal plant, which consists of separate packages of platinum catalyst on styrene divinyl benzene and CY Sulzer type hydrophilic packing.

An analysis of the technical characteristics for the catalyst types presented above indicates similar overall technical performance (Table 1.3.1.1).

Table 1.3.1.1 Technical characteristics for the catalyst types mentioned

Specification / Catalyst type	ICSI	Wolsong	AECL
Theoretically equivalent plate height - HETP (cm)	26 - 31	30	Unavailable
Isotopic transfer coefficient - Ks (mol / g * sec)	$1.9 * 10^{-4}$	$1.6 * 10^{-4}$	$1.6 * 10^{-4}$
Tritium extraction efficiency (*)	≥ 98%	97%	97%

(*) **NOTE:** The efficiency of extraction of tritium from tritiated heavy water is a characteristic of the installation and depends on the tritium removal factor (ratio of tritium concentrations to entry / exit from isotope exchange columns) established as the design input. The tritium removal factor of 50-100, set for CTRF (compared to 35, chosen for the similar tritium removal plant in Wolsong-South Korea) can be obtained by properly sizing the height equivalent (number) of the catalytic isotope exchange columns (3 CTRF columns, respectively 2 WTRF columns) with any of the catalyst types shown.

It should be noted that the presence of liquid water in contact with the catalyst has the disadvantage of its deactivation over time, which may lead to the need to reactivate, or replace a part of the catalyst during operation of the plant and thus to generate different amounts of waste and increase operating expenses. Catalyst selection criteria are related to the generation of a smaller amount of radioactive waste, the duration of manufacture, the stability of the supplier, the availability for procurement throughout the lifespan of the plant and the price of the catalyst, each of which may favor one catalyst or another.

By establishing the type of catalyst, the input data will be provided for the elaboration of the detailed design for the LPCE columns, and the differences between the possible options and those compared to the conceptual design (presented in the figures 1.3.1.4 and 1.3.1.5) may be related to the arrangement inside the columns and possibly to the height of the columns, without having an impact on the height of the building, which is dictated by the dimensions of Cold Box.

The chemical requirements for the 2 process fluids are as follows:

- The deuterium gas must be at least 99.3% pure D₂ and must not contain elements that could have the effect of "poisoning" the catalyst with which the isotope exchange columns are equipped.
- The water in the moderator must have a minimum isotopic content of 99.75% D₂O, and the water in the primary heat transfer system (PHT) must have a minimum isotopic content of 99% D₂O and a maximum conductivity of 2 μS / cm.

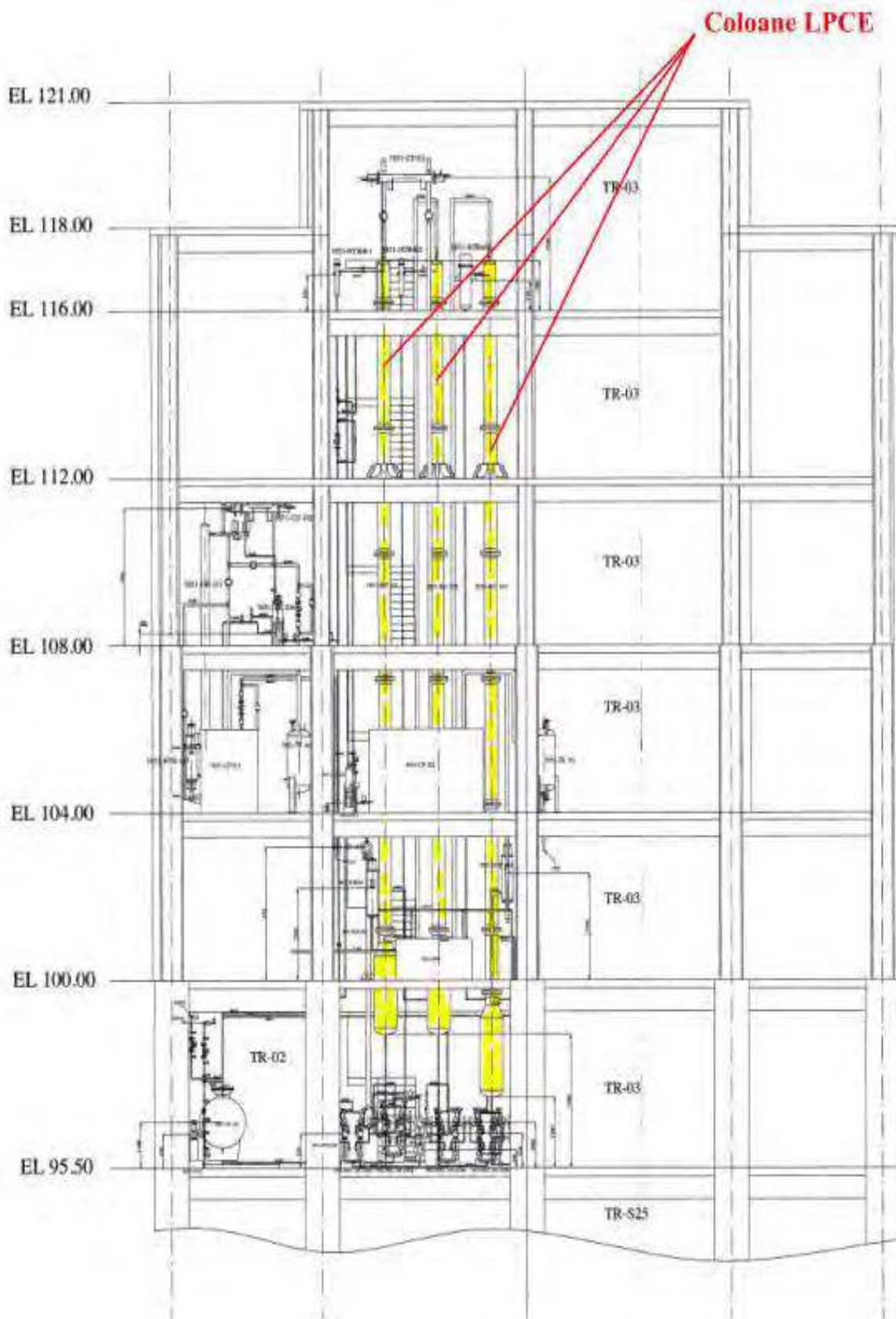

Figure 1.3.1.4 Catalytic isotopic exchange columns. Vertical section through the CTRF building

Source: "Nuclearelectrica" SA National Society, Presentation Memorandum - Construction works for Heavy Water Tritium Removal Facility, Variant for authorities - May 2019

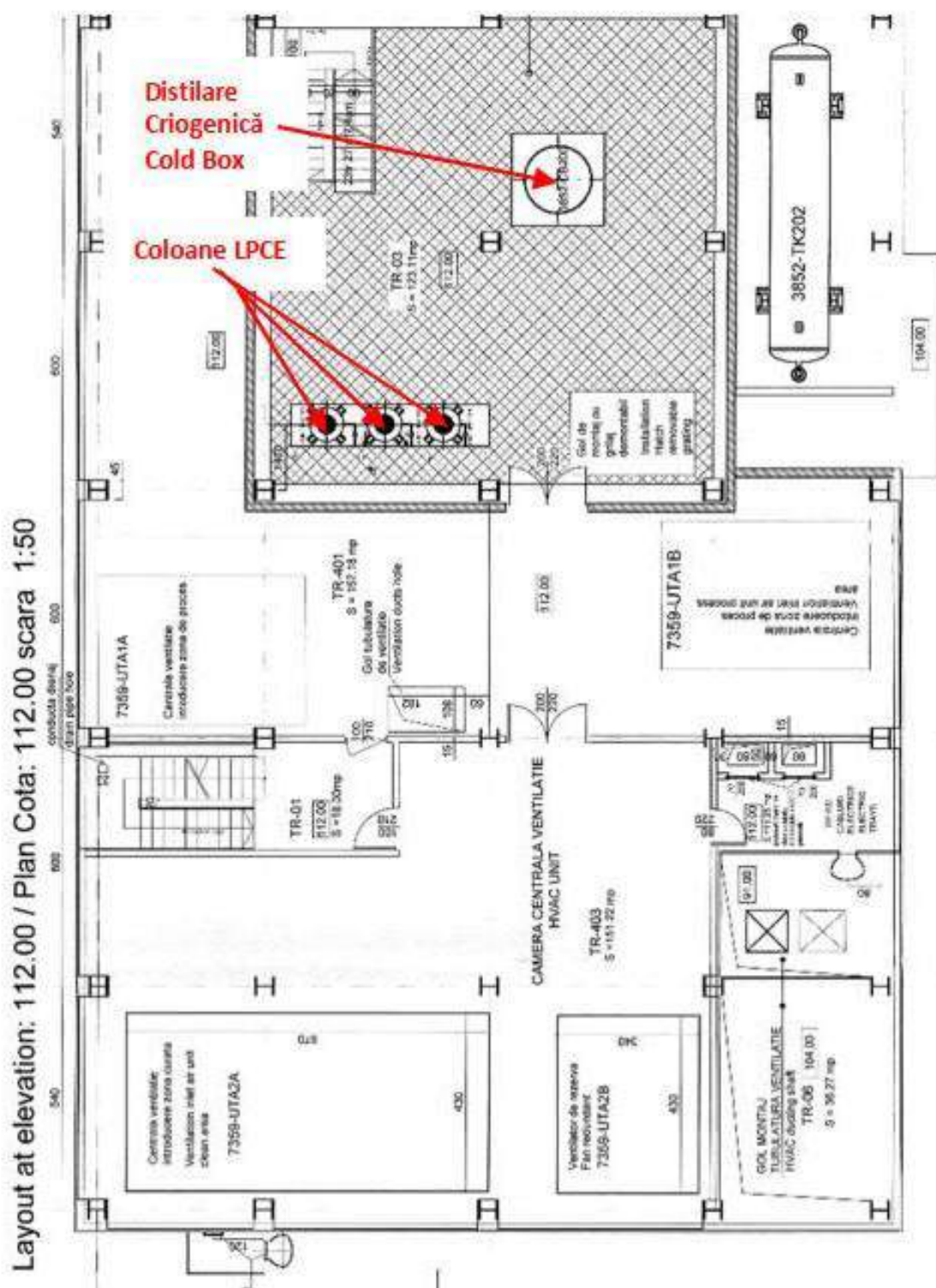

Figure 1.3.1.5 Catalytic isotopic exchange columns. Horizontal section through the CTRF building

Source: "Nuclearelectrica" SA National Society, Presentation Memorandum - Construction works for Heavy Water Tritium Removal Facility, Variant for authorities - May 2019

Purification of D_2 / DT / HD gas flow is achieved by:

- Moisture retention on molecular sieve systems (type 13X), at ambient temperature, removal of traces of nitrogen and oxygen by adsorption at low temperature (cryogenic).

Cryogenic distillation ensures the separation and concentration of tritium from the D₂ / DT / HD gas stream from LPCE by using a cascade of cryogenic distillation columns and two types of chemical balancers that have the role of balancing the deuterium-tritium mixture and producing tritium.

At the same time, at this stage, the purification of the D₂ / DT / HD gas flow is ensured by the final retention of any traces of nitrogen and oxygen on cryo-adsorption with activated carbon, in the 50K-60K range, before feeding the first cryogenic distillation column.

Chemical requirements:

- The process gas from LPCE will have a minimum isotopic deuterium / tritium content of 99.3%.
- The tritium (T₂) that will be extracted from the cryogenic distillation column will have a concentration > 99%.

Tritium gas storage ensures the fixation of tritium (T₂) on a titanium storage bed which consists of a vessel with a capacity of approximately 6.5 l, filled with sufficient spongy titanium. For the immobilization of tritium, spongy metallic titanium is used due to the low equilibrium pressure of tritium gas in titanium, at normal storage temperature (<1 Pa at 25°C), the ease with which the reaction between titanium and tritium takes place at ambient temperature, as well as safety in the storage of tritium, as its release requires the heating of metal tritride to high temperatures (> 400°C).

The tritium storage container on sponge titanium is capable of storing 52 g (500 kCi) of tritium containing 1% DT in T₂ and can also retain 3He (light isotope of helium having atomic mass 3) generated from the decay of tritium (figure 1.3.1.6). As the tritium retained on tritride disintegrates, the partial pressure of 3He increases. The total amount of tritium absorbed in the titanium bed disintegrates into 3He in about 6 half-lives (a half-life for tritium is about 12.3 years) which will bring the maximum pressure in the container to about 6.0 MPa (the container shall be designed to withstand a pressure of 7.4 MPa at 38°C).

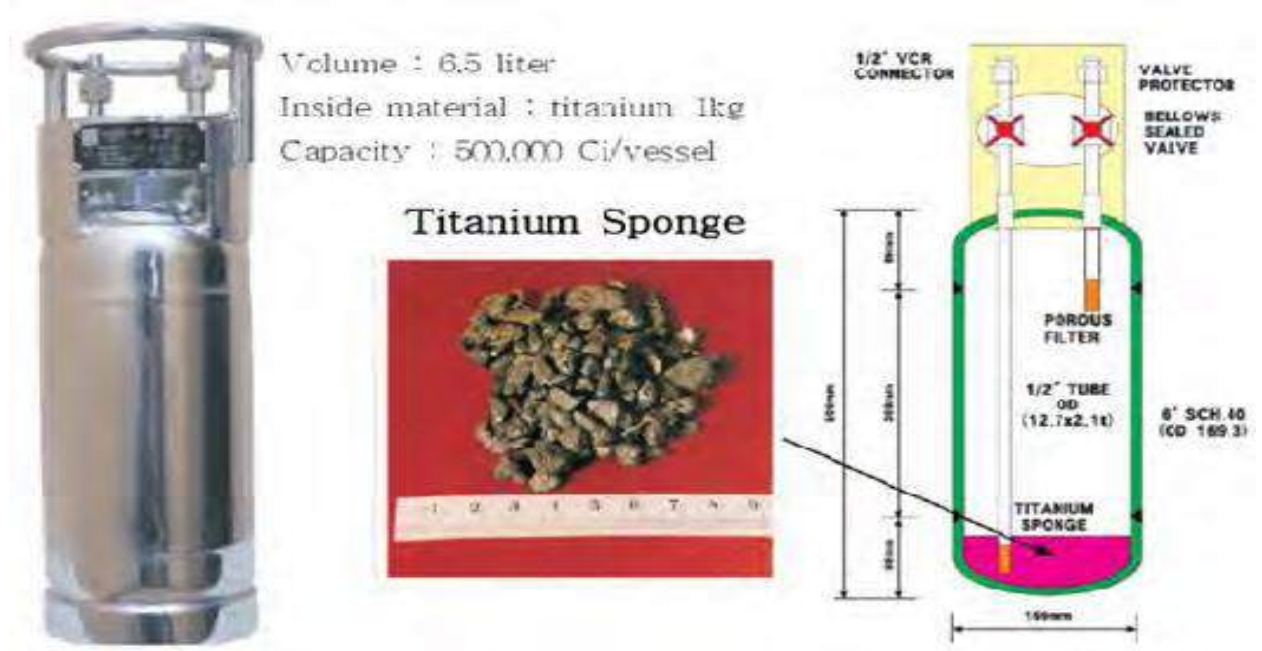

Figure 1.3.1.6 Container model for storing tritium on a titanium bed at WTRF-Korea

Source: "Nuclearelectrica" SA National Society, Presentation Memorandum - Construction works for Heavy Water Tritium Removal Facility, Variant for authorities - May 2019

Heavy water purification and transfer (detritiated heavy water) resulting from the catalytic isotope exchange (LPCE) aims to ensure heavy water of nuclear quality, before it is reintroduced into the D₂O supply systems of NPP.

The purification is performed by recirculating the heavy water, with a flow rate of 0.4-0.7 l / s, through the batteries of 2 ion exchanger columns, belonging to the detritiated heavy water management system - the produced heavy water system (HWPS - Heavy Water Product System).

The completion of the purification process is determined by tracking the value of electrical conductivity, by taking samples and analyzing them.

For the separate management of the tritiated heavy water inventory at U1 and U2, 2 similar HWPS installations were provided, one for each unit, which is located in the service building of the respective units.

The flow diagrams of the system of this process are presented separately for Unit 1 and Unit 2, in Figure 1.3.1.7, respectively Figure 1.3.1.8. The entire tritiated heavy water transport route, from CTRF to units U1 and U2, is equipped with a heating system to avoid freezing and it is also monitored online to detect, in real time, any accidental fluid leaks along the way and to take the necessary measures to prevent these leaks.

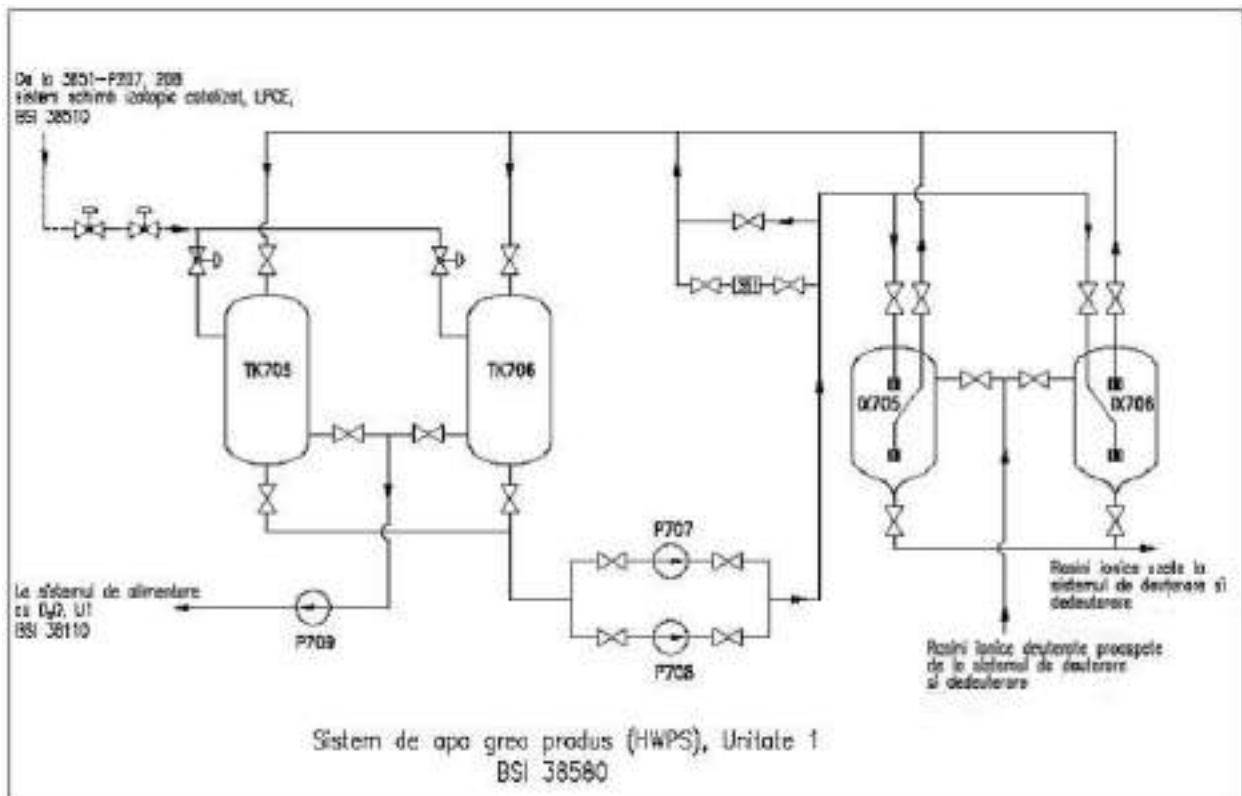

Figure 1.3.1.7 Product heavy water supply system (detritiated heavy water) HWPS - Unit 1

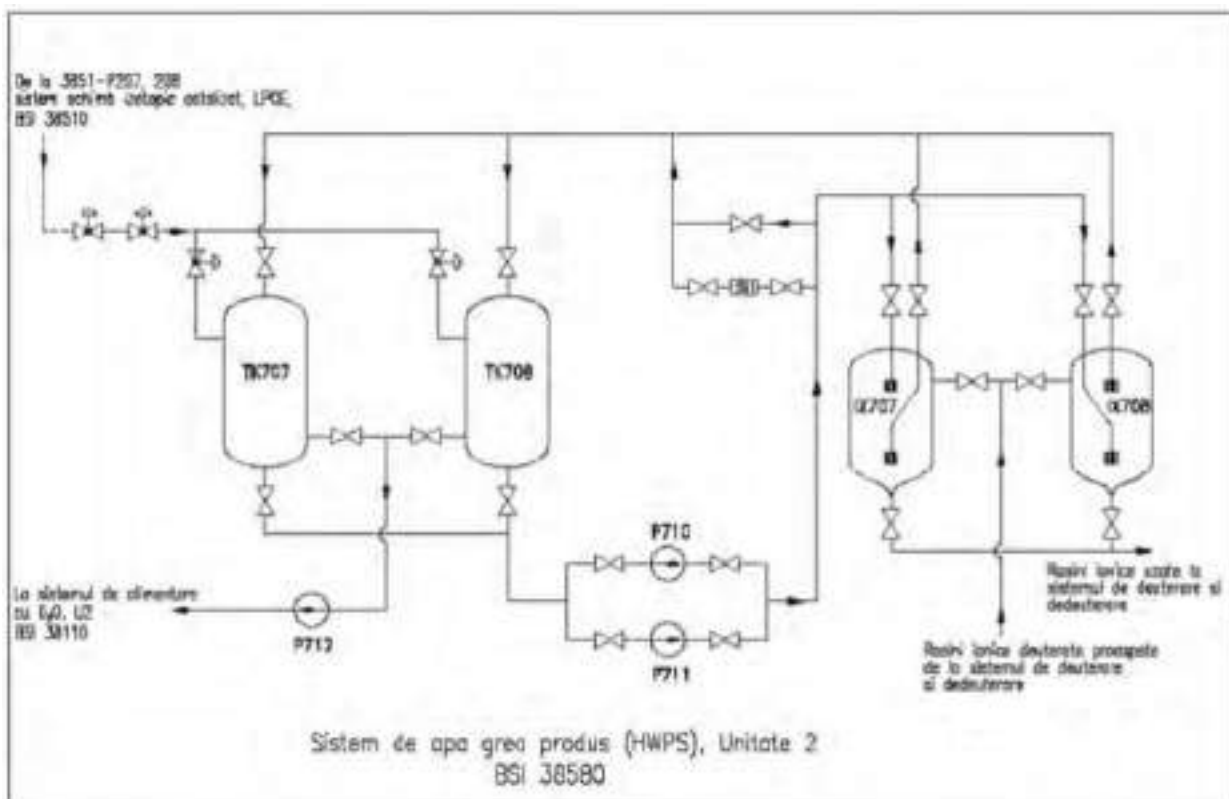

Figure 1.3.1.8 Product heavy water supply system (detritiated heavy water) HWPS - Unit 2

1.3.2 Raw materials, energy and fuels used, and how to procure them

The operation of the CTRF installation requires the use of raw materials and materials that will be purchased in a centralized system at the level of Cernavoda NPP, in addition to those already existing in the NPP (Table 1.3.2.1).

Table 1.3.2.1 Raw materials used for the operation of the CTRF installation

Crt. no.	Name	UM	Quantity
1	Virgin heavy water	Kg / year	50
2	Oxygen gas	Nm ³ / year	16,000
3	Liquid nitrogen	l / year	20,000
4	Helium gas	Nm ³ / year	100
5	Hydrophobic catalyst	Kg / year	47.5
6	Recombiner catalyst	Kg / year	22.5
7	Activated charcoal	Kg / year	95
8	Ion exchange resins	Kg / year	52
9	13x molecular sieve	Kg / year	332
10	Instrumental air	Nm ³ / year	320,000
11	Breathing air	Nm ³ / year	21
12	Sewage water	m ³ / year	1,620
13	Fire extinguishing water	m ³ / year	18

14	Mineral oil	Kg / year	20
15	Other technical gases	Nm ³ / year	1,120
16	Electricity	GWh	16
17	DeminerIALIZED water	Kg / year	1,000

Source: National Research and Development Institute for Cryogenic and Isotopic Technologies ICSI Rm. Vâlcea, Feasibility study for the tritium removal installation Cernavoda NPP Rev. 11, document code 79-38500-SF-001, 2018.

• **Power**

The CTRF installation will not be connected directly to the national electricity grid.

The power supply of the installation is made from service transformers 5135-TC01 and 5135-TC02, connected to Cernavoda NPP.

The installed electrical power consumed by the tritium removal facility is approximately 4500 kW. The total required power at the 6 kV, class IV CTRF substation is approximately 3500 kVA.

For the supply of vital consumers of 0.4 kV class III, in case of loss of power supply of 6 kV class IV, internal power supplies are provided represented by the 600 kW (2 x 100%) Stand-by Diesel Generators and respectively by the Uninterruptible Power Supplies (UPS), for a short period of time, until the nominal capacity is reached by the Diesel Generator or the plant is safely shut down. The UPSs will ensure for one hour the operation of the ventilation, the tritium and hydrogen monitors and the safe shutdown of the installation.

Fuel used for the operation of the 2 Stand-by Diesel generator groups, will be diesel fuel. It is estimated that in the operation of the generators in the testing period of 2 hours / month, the 2 Diesel generators will consume a quantity of approx. 6480 L / verification cycle. In addition, an estimated amount of approximately 9775 L will be added, for the activities related to waste disposal and diesel supply of the 2 Stand-by Diesel generator groups.

Internal transport activities for the CTRF supply have not been taken into account in the calculation of fuel requirements, as these materials will be transported by electric vehicles.

1.3.3 Type and quantity of finished products resulting from the project

The finished product of the CTRF project will be detritiated heavy water. CTRF will produce 40 kg/ h of detritiated heavy water and will have an operating period of 8000 h / year, thus totaling a quantity of 320 tons of finished product/ year according to the technical data provided by Cernavoda NPP.

Following the technological process, the removed tritium will be fixed on the titanium bed, thus resulting in a by-product with potential for marketing.

1.3.4 Facilities for the retention, evacuation and dispersion of pollutants in the environment

Installations for the retention and dispersion of pollutants in the atmosphere

HVAC ventilation system - has the role of safety and comfort, being composed of 6 mechanical air ventilation systems in the CTRF building, organized as follows [1]:

- an S1 ventilation system, in the area of technological installations (area with potential for contamination and / or explosion - area with hydrogen):
 - ensures the evacuation of possible hydrogen accumulations from the technological area, by evacuating the air from the rooms in the respective area; to ensure a safe system, the areas containing hydrogen in the installation have 10 air changes per hour (approximately 55,000 m³ / h);
 - the air is ventilated (directed) to the exhaust stack of approx. 50 m attached to the CTRF installation;



- the hydrogen ventilation system will be powered by the Class IV system, and on loss of class IV, from the Stand-by Diesel generator groups and batteries;
 - hydrogen and tritium monitors are distributed inside the CTRF building as well as monitoring the flow of ventilated air from the exhaust stack;
 - manual shutdown of the ventilation system and its manual isolation for certain rooms, in case of accidental occurrence of tritiated water vapor in a CTRF room, followed by manual start of the atmospheric tritium removal system (ADS);
 - ensures the temperature of 15-20°C in the technological area;
 - the introduction and evacuation ventilation plant in the hydrogen process area have a 100% reserve.
- an S2 ventilation system, in the area of auxiliary systems (area without hydrogen, approximately 45,000 m³ / h);
 - an S3 ventilation system in the electric battery room (approximately 3 000 m³ / h);
 - an S4 ventilation system, in the area occupied by the operating personnel (approximately 1500 m³ / h):
 - min. 6 air changes / h (area where there is no danger of explosion);
 - must ensure temperatures of 20-26°C;
 - air circulation will be from the area occupied by the operating personnel to areas with potential for contamination (technological zone) by increasing depressions. Thus, the highest depression will be ensured in the tritiated water processing area,
 - area at risk of contamination;
 - an S5 ventilation system in the helium compressor chamber (approximately 15,000 m³ / h);
 - an S6 ventilation system, in the air compressor chamber (approximately 2000 m³ / h).

Dispersion system - the evacuation of the gaseous effluents from the ventilation systems S1, S2 and S3 in the atmosphere is made through CTRF installation stack with the following characteristics [1]:

- Stack height: 50 m
- Inner stack diameter: approx. 1.7 m
- Stack section: approx. 2.3 m²
- Exhaust flow: 103,000 m³ / h = 28.6 m³ / s
- Evacuation speed: approx. 12.4 m / s

Exhaust flows are designed to ensure the efficient evacuation of hydrogen from the building, in order to prevent the accumulation of hydrogen in the premises, therefore, preventing the potential danger of reaching the explosion concentration.

The S4, S5 and S6 ventilation systems circulate clean air, without any danger of contamination, its evacuation of which is made directly outside of the building.

Installations for the retention and dispersion of pollutants in water

Active drainage - CTRF installation

Potentially contaminated fluids from the CTRF technology area (potentially radioactive liquid waste, including used water from the fire extinguishing system and water resulting from equipment decontamination) will be gravitationally collected in a sealed tank (0.8 m³ volume) located in the basement of CTRF building, from where they will be transferred by pumping to the U1 Radioactive Liquid Waste Management System.

The Active Drainage System consists of a network of floor drains located in each room as well as the drainage pipes to the active drainage sump of the CTRF building.

The system can collect water from the LCS system (which in turn collects any process water leaks) if the isotopic content of the collected water is less than 0.5%.

The maximum possible flow to be taken over by the active drainage system and collected in the tank is 3.7 l / s.

From the sealed tank, potentially radioactive liquid waste is transferred controlled by pumping to the Active Drainage System in the U1 Service Building, by means of pipe-in-pipe ducts provided with a monitoring system for leak detection, from where it is then emptied into the Radioactive Liquid Waste Management System. The volume of the tank and the transfer system have been calculated so that it can take up the maximum amount of water that could accumulate and avoid flooding the first basement of the CTRF.

The domestic and rain sewerage system presented in subchapter 1.3.5. is added to the 2 installations intended for the retention and dispersion of pollutants in water.

Installations for the retention and dispersion of pollutants in the soil

Heavy-water leak detection system ensures the detection of accidental leaks of tritiated and detritiated heavy water from the technological transfer pipes from Units 1 and 2 to and from the tritium removal installation from Cernavoda NPP. The transfer pipe system is designed in a "pipe in pipe" configuration, thus ensuring protection in the event of a crack in the pipe through which the heavy water is being transferred. The signaling of the occurrence of possible leaks will be made at the main control room of Unit 1, respectively of Unit 2 and at the control panels that will be installed in rooms S015 of Units U1 / U2. The technological pipelines are provided with a concentric accompanying pipe along the entire route.

Heavy water drainage and collection system – The role of **LCS** is the management of the heavy water resulting from the emptying of the installation during the periods of failure and maintenance operations, in order to reuse it in the process or return it to the Cernavoda NPP systems Units 1 and 2, as the case may be. LCS consists of a network of drain pipes ((by placing trays to collect any leaks) that take over any leaks from the equipment containing process water (LPCE, TRS, ADS and DMS) which is connected to a collector that supplies a 0.8 m³ tank located in a vat [1]. The system also collects water from showers, sinks, washing machines (from level 104.00).

An additional measure of soil protection, are the concrete platforms in the area of the location of diesel tanks which will be designed and installed with means of prevention and collection of leaks.

Other tritium retention or recovery systems (closed circuit)

ADS atmosphere detritiation system - with the role of decontamination (tritium removal) of the air by recovering vapors from the area where the tritiated heavy water processing / storage equipment is located, when the tritium concentration in the air exceeds the established thresholds, in case of accidental leaks or failures.

The principle of operation of the atmosphere detritiation system is the evacuation of air from the technological area through an installation in which D₂O / DTO / H₂O vapors are adsorbed in a desiccant mass. Tritium and hydrogen in gaseous form are catalytically oxidized to tritiated water, followed by condensation of tritiated water vapors and drying of the gaseous effluent on molecular sieves. In the catalytic recombiner, 99.9% of the hydrogen isotopes are catalytically oxidized to tritiated water. Less than 0.1% of tritium gas will not be oxidized.

The air thus treated is recirculated to the rooms where the increase in tritium concentration has been detected. A hydrogen detector is provided on the ADS supply circuit to prevent an explosion in the event of system operation, by accumulating hydrogen in the system supply line.

TRS tritium retention system - has the role of ensuring the recovery of tritium and deuterium from all processes involving waste gas streams and purge gases generated during normal operation, maintenance activities (purging and evacuation from the equipment) and / or the start of process systems.

The mode of operation of the TRS system is of stand-by type, the system entering normal operation mode at the time of carrying out maintenance operations, commissioning, planned shutdowns or in case of emergency.

The TRS tritium retention system has the ability to process, simultaneously and independently, tritium deuterium from technological systems and aspirated contaminated air from various locations where maintenance operations are performed [1].

1.3.5 Utilities required for the operation of the CTRF

Water supply - the existing situation

Currently, the water supply and wastewater discharge for U1 and U2 Cernavoda NPP is regulated by the Water Management Authorization Modifying the Authorization no. 58 / 07.2021, No. 72 of 06.09.2021 for Cernavoda NPP U1 and U2, issued by the National Administration of Romanian Waters [12].

The drinking water supply of Units 1 and 2 is made from underground through 3 deep boreholes, two located in the enclosure and one located in the NPP Campus area [1]:

Fj1 H= 700 m; N_{hs}=4m; N_{hd}=10m; Q= 16 l/s;
Fj2 H= 700 m; N_{hs}=3,1m; N_{hd}= 5m; Q= 28,5 l/s;
Fj3 H= 700 m; N_{hs}=5,17m; N_{hd}=5,92m; Q= 21,2 l/s.

Zonal drinking water supply system of the city of Cernavoda, operator RAJA SA Constanța - constitutes a reserve.

Technological (industrial) water supply - the source is the Danube river - Bief I of the Danube-Black Sea Canal, through the bypass canal. The degree of use assurance is 97%.

Water supply for extinguishing fires - The water source for extinguishing fires is the water from the Danube, taken either from the bypass canal after passing through a 5 mm diameter mesh filter, or after passing through the rotating sieves related to the technical service water system and Brassert filters related to the fire extinguishing water system [1].

Water supply for hygienic-sanitary purposes of the CTRF installation

Provision of the necessary water for hygienic-sanitary purposes for the staff carrying out the CTRF activities, approximately 15 users (in 24 hours), will be performed by connecting to the internal water supply network of U1 Cernavoda NPP, existing in the vicinity of the CTRF site.

Water is supplied to the CTRF installation by pumping from the corresponding system U1. The connection from the water distribution network for U1 to the connection of the CTRF installation, measures approx. 30 m and will be made of HDPE PE 100 pipe, Dext 63 x 2.5 mm, SDR 26, Pn 6.

Hot water is prepared locally using electric boilers.

During the construction-assembly period, domestic water is used, this being ensured by the existing facilities near the project site.

Technological water supply of the CTRF installation

Technological water is required starting with the technological testing and commissioning phase.

The need for technological water that ensures the operation of the chilled water system and the cooling water system is represented by the demineralized water produced within the Water Treatment Plant (STA) on site and integrates [1]:

- **Demineralized water demand 1** - for the initial filling of the chilled water system;

The demineralized water demand 1 ensures the commissioning of the two chillers (one active and one in reserve) located on the concrete platform, on the roof of the CTRF building.

The system works continuously, in closed circuit, the necessary demineralized water representing the recirculated water flow in a percentage of 99%.

Qn techn 1 day med = 2.7 m³ / day = Qrec 1

- **Demineralized water demand 2** - for the initial filling of the cooling water system; ensures the cooling of various equipment in the other systems of the CTRF installation (eg cooling of the electrolyzer in the deuterium gas make-up system, cooling of the helium compressors in the refrigeration unit of the distillation system, cooling of the process compressors and CP302, cooling of the gases in the TRS chiller, cooling of detritiated heavy water from LPCE).

The system operates continuously, in closed circuit, the necessary demineralized water representing the recirculated water flow in a percentage of 99%.

Qn techn 2 day med = 6.2 m³ / day = Q rec 2

- **Demineralized water demand 3** - for various subsequent supplements of consumers in the chilled water and cooling water systems.

Qn day techn 3 med = 0.025 m³ / day = 9.125 m³ / year

- **Demineralized water demand 4** - for washing or decontamination of equipment and components related to LPCE.

The demineralized water distribution network will be made of stainless-steel pipes.

For abnormal situations, the designer has provided a maximum additional flow of 0.5 m³ / h. Also, in case of emergency situations, a volume of water for washing / decontamination required of about 6 m³ was estimated.

During the construction-assembly works, no technological water is used.

Water supply for fire extinguishing of the CTRF installation

The supply of the CTRF installation building with fire extinguishing water is done through a connection to the fire extinguishing water supply system of the Cernavoda NPP platform.

External fire hydrants with Dn 110 mm (HDPE pipe) will be provided on the fire extinguishing distribution network related to the CTRF installation, which will ensure a flow rate $Q_{ie} = 15 \text{ l/s}$ as well as internal fire hydrants with Dn 100 mm, which will ensure a flow $Q_{ii} = 2.5 \text{ l/s}$ [1], located at all levels of the CTRF building, which will be supplied with water from the existing external fire-fighting water network inside the Cernavoda NPP through 2 connections of 2 ½", each sized for the entire water flow required during a potential fire.

A H-CTRF fire hydrant with Dn 110 mm is placed on the outer pipe. In the event of an external fire, fire-fighting water is provided by means of this new hydrant and those existing on the fire-fighting water supply network.

Domestic and rainwater drainage circuit

Existing situation

Domestic wastewater from the Cernavoda NPP platform reaches the Cernavoda Wastewater Treatment Plant, which discharges the treated wastewater through Seimeni discharge channel into the Danube (Cernavoda NPP cooling water channel), the evacuation point being located before the cooling water discharge into the Danube.

Rainwater discharge is made in the distribution basin of Cernavoda NPP, including discharges from underground drainage, inactive drainage from the turbine building, reactor buildings U1 and U2, SDG (Stand-by Diesel Generator) Diesel groups-backup generator buildings U1 and U2, siphon basin (2), Thermal Start-up Plant (CTP), the waters resulting from the washing of the STA mechanical filters and the wastewater from the fuel oil separator from the overflow of the demineralized water tank, and from the overflow of the filtered water tank.

Circuit related to the CTRF installation

The project will be connected to the domestic sewerage and rainwater drainage systems, respectively to the Radioactive Liquid Waste Management System from U1, whose sizing / capacity also allows the necessary supply for the CTRF installation.

Domestic wastewater - CTRF installation

Domestic wastewater from the CTRF building is from the building's sanitary facilities.

The domestic sewerage system ensures the collection, transport and discharge of domestic wastewater, through an external connection made in a separate system, in the existing domestic sewage network of U1 on the Cernavoda NPP platform, in the immediate vicinity of the CTRF site.

Rainwater drainage - CTRF installation

Rainwater from the CTRF and from the access roads in the area of the new CTRF building will be collected, transported and discharged through an external connection, made in a separate system, in the existing stormwater drainage network on the Cernavoda NPP platform, immediately near the new CTRF building and finally in the distribution basin of the Cernavoda NPP.

The rainwater flow from CTRF is estimated at $Q_p = 24.85 \text{ l / s}$.

The collection, transport and evacuation of rainwater will be done through a collector channel with a length of approx. 50 m, made of polyvinyl chloride tubes - PVC, class SN4, with Dn 315 mm.

Heating

The heating of the rooms of the CTRF building will be provided by the ventilation and air conditioning system.

Providing the necessary electricity

The power supply of the installation is made from Cernavoda NPP service transformers 5135-TC01 and 5135-TC02.

1.3.6 Hazardous materials used, stored, handled or produced during the project operation

It is estimated that in the current activity of CTRF materials / substances and chemical preparations classified as hazardous will be used, from the following categories:

- lubricants (oils and Vaseline);
- oxygen;
- biocides (for cleaning, washing equipment, etc.);
- environmental friendly freons;
- glycol;
- fire extinguishing substances;
- fossil fuel (diesel);
- equipment cleaning products (Avesta paste);
- degreasing solvents;
- coating mixtures (primer, paint).

The estimated quantities of hazardous materials used, stored or handled during the period of operation are given in Table 1.3.6.1.

Table 1.3.6.1 Estimated quantities of hazardous materials used, stored or handled during operation

Hazardous chemicals	Estimated quantities
Nitrogen	Maximum 6400 liters (4155 m ³ at 1 bar / 15°C)
Helium	8 cylinders (50 liters / piece at 20 MP(a))
Inergen (inert gas for extinguishing fires)	30 active cylinders + 30 backup cylinders (80 liters / cylinder / 200bar)
Oxygen	16 cylinders (20 MPa (g))

Hydrogen	Approx. 310 Nmc
Diesel fuel	3000 liters
Biocides (for cleaning, washing equipment, etc.)	Minor quantities used from the plant's stocks in maintenance activities
Equipment cleaning products (avesta paste)	Minor quantities used from the plant's stocks in maintenance activities
Degreasing solvents	Minor quantities used from the plant's stocks in maintenance activities
Coating mixtures (primer, paint)	Minor quantities used from the plant's stocks in maintenance activities
Lubricants (oils and Vaseline)	Minor quantities used from the plant's stocks in maintenance activities

Biocidal products will also be accompanied by Permits issued by the Ministry of Health in accordance with the provisions of GD no. 617/2014 on the establishment of the institutional framework and measures for the implementation of Regulation (EU) No. 528/2012 of the European Parliament and of the Council of 22 May 2012 concerning the making available on the market and use of biocidal products, with subsequent amendments and supplements.

Only chemicals that comply with the requirements for classification, packaging and labeling in accordance with EC Regulation 1272/2008 (CLP) with subsequent amendments and supplements will be accepted for use.

The management of dangerous chemical substances and preparations will be carried out only in accordance with their Safety Data Sheets drawn up in conformity with Regulation (EC) No 1907/2006 (REACH) with subsequent amendments and supplements, the environmental legislation in force, the requirements of the applicable Permits, agreements, authorizations and according with the requirements of the procedures regarding the listing of chemicals approved for use in Cernavoda NPP.

According to the Cernavoda NPP procedures, the chemicals are stored in the manufacturer's packaging, and there are procedural requirements to ensure the integrity and tightness of the packaging. This includes proper labeling with information on the correct product name, trademark and manufacturer's name, date of manufacture, warranty period, data strictly necessary to avoid chemical hazards, first aid, disposal of residual products and, where appropriate, restrictions on the use of the product.

The use of chemicals, especially toxic and dangerous ones, is carried out with work safety equipment and facilities according to the regulations in force. Personnel handling, storing, transporting and using chemicals shall be trained for these activities in accordance with the applicable law and the specific tasks described in the Job Description. For the CTRF needs, the chemical substances and preparations will be supplied in the necessary quantities for the development of the production process, respectively for interventions / repairs, avoiding the creation of unjustified stocks. The minimization of the use of chemical substances and preparations in the construction / assembly stage will be achieved by using prefabricated, equipment subassemblies, with finishes made at their place of production (e.g. prefinished metal panels for construction walls, supply of concrete mixers instead of concrete preparation on the site of Cernavoda NPP). Chemical products used in various phases will be held in approved temporary premises in accordance with the internal procedure for allocating these facilities to contractors (Operating Manuals: Handling and storage of chemicals, code 03410-OM-SM-1-22; Chemical's administration code, OM34000). The approved range and quantity for these products will be limited to short-term use [1].

The procedures of the existing chemicals management program will also integrate the management of these substances used within the CTRF installation.

1.3.7 Transport of raw and auxiliary materials and increased traffic involved during operation

Raw / auxiliary materials (nitrogen, helium cylinders, oxygen cylinders, diesel for Stand-by Diesel generator Groups), fire extinguishing materials (Inergen cylinders, eco-friendly foam, portable fire

extinguishers), as well as devices / equipment / backup parts, etc. will be transported for the supply of the CTRF installation.

It is estimated that due to the quantities supplied and the possibility of merging with the supply for other Cernavoda NPP facilities, the increase in traffic and emissions resulting from transport activities will have an insignificant share compared to the absence of the CTRF installation.

1.3.8 Environmentally relevant social and socio-economic implications

From a socio-economic point of view, the implementation of the CTRF project has a clearly positive impact on the development of the area and on the improvement of the quality of life. As an effect on the environment, the carrying out of the project will bring economic opportunities to the region in which it is located, both during the construction period and during the operation period [2].

The economic benefits of the CTRF project are as follows:

- Making the investment from own funds and attracted funds, cumulated with the long-term beneficial effects resulting from the decrease of the costs with tritiated heavy water and the facilitation of the maintenance activities in radiological areas, represent economic-financial advantages both on the short and long term as well as a guarantee of the continuity of the activity for SNN SA through Cernavoda NPP;
- During the construction period of the project, an average number of approximately 100 employees from the construction-assembly companies will be involved in carrying out the works, for a period of approx. 5 years, according to the current stage of the CTRF project;
- Business growth in the area will be particularly felt in the construction sector, at the local level, both for building companies and manufacturers of construction materials;
- A number of approximately 26 new jobs directly related to the activity during the operation period will be created at the level of the production unit achieved through the implementation of the project.

Regarding the human health, the CTRF installation will lead to the reduction of the tritium intake in the doses received by its own staff and by the contracting staff, as well as of the tritium emissions from the Cernavoda NPP units, with a positive impact on the population and the environment. Thus, it is estimated that, by commissioning and operating the CTRF, the dose received by the professionally exposed personnel, working in U1 and U2 in areas with significant radiation exposure, will be reduced proportionally with the decrease of the tritium concentration in the Moderator System and the Primary Heat Transfer System.

The dose for one person in the critical group due to atmospheric emissions of DT and DTO (vapors) in normal CTRF operation is estimated at approx. 0.64 - 0.75 μSv / year (depending on the DT / DTO ratio), well below the 10 μSv / year dose constraint set by CNCAN for CTRF [2]. At the same time, the tritium emission into the atmosphere from Units 1 and 2 of the Cernavoda NPP will be significantly reduced. The estimated emission reduction is approx. 17% from the very first year of operation of the CTRF, which will lead to a proportional reduction in the dose received by the population.

At the same time, given the dynamics of tritium concentrations in the nuclear unit systems and tritium emissions into the atmosphere, with the detritiation of water from the U1 moderator and the reduction of tritium concentration with factors ranging from 0.5 at start-up, 0.7 after the first year and more than 0.8 after the second year, there will be a decrease of the specific activity in the moderator by approx. 37% and the total emission at U1 by ~ 22% in the first year. After 2 years, the activity of tritium in the moderator will decrease to 30% of the initial value, and after 3 years to 14% of the initial value - dropping below 10 Ci / kg. Similarly, if the tritium removal process is applied to the tritiated heavy water in the U2 moderator circuit, the tritium inventory in this circuit will decrease over time, which will lead to a reduction in emissions and, consequently, to a reduction in doses for the population and for professionally exposed workers. Under these conditions, the dose to the public due to all Cernavoda nuclear units will decrease after 3 years (without detritiation in PHT) to ~ 42% of that estimated to be achieved in the absence of detritiation [3].

1.3.9 Possible future changes to the project

No future changes to the project are currently being considered.

1.4 Estimation, by type and quantity, of the expected waste and emissions

1.4.1 Waste and emissions expected to be generated during the technological testing / commissioning test period

In the stage of technological tests and commissioning, once the construction works have been completed, the pollution sources from this stage are reduced to minimum until non-existent. The sources of pollutants specific to the operating stage become active and the installations for the retention, evacuation and dispersion of environmental pollutants, operate at the process parameters [1]. In view of these issues, the information on the expected emissions to be generated during the testing period / commissioning tests is presented below.

In the CTRF operation both stationary sources related to the tritium removal facility and the two Stand-by Diesel groups, as well as temporary mobile sources (supply machines of the unit) will be present.

The technological process of tritium removal will result in controlled radioactive emissions of tritium discharged to the stack of the CTRF installation.

Auxiliary and support activities may also result in emissions of particulate matter, volatile organic compounds (VOCs) and diesel fuel used as fuel for Diesel generators, as well as fuel combustion and particulate resuspension due to transport and traffic activities in the enclosure.

- **Punctual sources – directed radioactive emissions**

Under normal CTRF operation, there are two situations [1]:

a) Operation, the process of detritiation of heavy tritiated water from Units 1 and 2 is carried out at nominal parameters and all component systems of the installation are operational. For this situation, the entire tritium inventory is in a closed system, in the CTRF circuits, its management being carried out by controlling the process temperatures and pressures (spaces with nuclear systems are maintained at a lower pressure than normal, thus preventing any potential accidental escape of radioactivity outside). The maximum tritium inventory of CTRF systems and components estimated for normal operation of the installation is $9.2E + 15$ DT (Bq) and $7.8E + 15$ DTO (Bq).

b) Planned shutdown, whose frequency is 1 / year, when the CTRF installation will be completely shut down for maintenance and repair work. This assumes that all process systems will be shut down, except for the two sub-components of the Tritium Retention System – TRS, which have the role of taking over and managing the tritium inventory from the cryogenic distillation unit, so that the works in the premises of the installation can be carried out in optimal conditions:

- Low Tritium Expansion Tanks (LTET) ensure the collection and management of the tritium inventory from the cryogenic distillation columns 1, 2 and 3 of the CDS during the maintenance period. The project is expected to be equipped with 3 overlapping LTETs and positioned outside the CTRF building.
- The High Tritium Expansion Tank (HTET) ensures the collection and management of the tritium inventory from column 4 of the CDS during the maintenance period. The project is equipped with a single HTET, positioned in the glove box that houses the pumps of the cryogenic distillation unit.

According to the legal provisions (Art. 51 of the Norms regarding the basic requirements of radiological safety, CNCAN), the derived emission limits (LDE) of tritium for CTRF will be approved by the national regulatory authority in the nuclear field, CNCAN, in the authorization process.

- **Other directed sources**

In situations of power failure, the Stand-by Diesel groups (2 x 100%) will be used for the systems that do not allow interruptions. These will be sources of particulate matter and diesel fuel – mainly CO₂, SO₂, NO_x and hydrocarbons. The estimation of the quantities of pollutants is done by calculation, because the operating regime (stand-by equipment) does not economically justify the installation of measuring instruments in the stack.

These sources will be characterized by short-term emissions, usually due to periodic tests, which will be regulated by CNCAN-approved operating routines. Euro 5- low sulfur diesel will be used and, based on experience with the emissions of other combustion plants on site, it is estimated that the impact of this equipment on the atmosphere will be negligible. In accordance with the legal requirements, this equipment will be subject to the revision of the GHG authorization of Cernavoda NPP.

Diesel loading in the two new tanks with capacities of approx. 1500 l, each, is a category of activities with short-term emissions of volatile organic compounds (VOCs), which will take place on a low frequency basis, and the storage of diesel in these tanks is also a source of VOC emissions. Considering the safety requirements taken into account when designing the tanks, due to the specificity of the Cernavoda NPP objective, the small size of the tanks, the lower volatility of diesel compared to other fuels, and the decrease of volatilization due to the inclusion of tanks in the premises – with protection from solar radiation, it is estimated that VOC emissions from these categories of activities will be insignificant [1].

- **Mobile sources**

During operation, the mobile sources of air pollutants will be the transport of auxiliary materials (eg nitrogen, helium cylinders, oxygen cylinders, diesel for diesel units – backup generator), materials such as fire extinguishers (Inergen cylinders, eco-friendly foam, portable fire extinguishers), as well as devices / equipment / backup parts, etc.

Pollutant emissions from material transport activity are dust and exhaust gases.

It is estimated that due to the quantities supplied and the possibility of merging with the supply for other Cernavoda NPP installations, this category of sources will generate insignificant emissions of pollutants (dust and burnt gases) compared to the existing situation in the absence of CTRF installation.

There are no sources of odors as a result of operating or supplying various auxiliary materials or fuels to the Stand-by Diesel generator sets [1].

Information on the expected generation of the waste during the technological testing / commissioning test will be presented in Chapter 1.4.3.

1.4.2 Types, codes and quantities / volumes of waste generated by the project during the construction phase

Non-radioactive waste

The estimated quantities of non-radioactive waste generated during the construction period of the project are presented in Table 1.4.2.1.

Table 1.4.2.1. Estimated amounts of non-radioactive waste generated during the construction period

Types of waste	Description	Waste code	Quantity / volume tons
Concrete	Simple concrete	17 01 01	39
Mixtures of concrete, bricks, tiles and ceramic materials other than those specified in 17 01 06	Mixture of concrete, bricks, tiles, ceramics	17 01 07	4.5
Mixed municipal waste	Household waste – office area	20 03 01	5.1
	Household waste – Pre-assembly area + work staff		13.7
Iron and steel	Metal grille	17 04 07	0.1
	Structural steel elements and HVAC units		3
	Stainless steel pipes for project networks		3.6
	Waste from scaffolding	17 04 05	1
	Metal scrap from plate elements (corrugated iron)		1
	Welding electrodes and fasteners		1
Soil and stones containing dangerous substances	Contaminated soil (accidental oil / diesel spills, etc.)	17 05 03 *	12
Soil and stones, other than those mentioned in 17 05 03 *	Soil and stones from excavations	17 05 04	18700
Paper and cardboard	Waste paper and cardboard – Office area	20 01 01	2.9
	Waste paper and cardboard – Pre-assembly area + work staff		7.2
Plastic materials	Plastics resulting from office and pre-assembly areas	20 01 39	22.5
Plastics in construction and demolition	Plastic elements and plastic pipes	17 02 03	1
Packaging that contains residues or is contaminated with hazardous substances	Packaging containing or contaminated with hazardous substances (non-radioactive)	15 01 10 *	2
Absorbents, filter materials (including oil filters not otherwise specified), polishing materials, protective clothing contaminated with hazardous substances	Absorbents, filter materials (polishing materials, protective clothing contaminated with dangerous substances)	15 02 02 *	0.5

Glass	Glass waste – resulting from office and pre-assembly areas	20 01 02	2.9
Plastic packaging	Packaging waste – plastic	15 01 02	6.5
Metals	Metal elements resulting from office and pre-assembly areas	20 01 40	1.7
Wooden packaging	Packaging waste – Wood	15 01 03	10
Composite packaging	Composite packaging materials	15 01 05	0.1

Non-radioactive waste that is defined as hazardous has one or several hazardous properties listed in Annex 4 of GEO 92/2021.

The danger of waste is given by its composition. The classification and determination of the chemical composition of hazardous waste shall be made based on certain tests performed by accredited laboratories, where necessary.

Radioactive waste

As no radioactive materials or radiation sources are used during the construction phase, no radioactive waste will be generated.

1.4.3 Types, codes and quantities / volumes of waste generated by the project during operation

Non-radioactive waste

The CTRF activity results in non-radioactive waste similar to municipal waste and industrial waste, presented in the table 1.4.3.1.

Table 1.4.3.1 Estimated amounts of non-radioactive waste generated during the entire operation

Types of waste	Description	Waste code	Quantity / volume tons
Paper and cardboard	Paper and cardboard waste – Personnel of the installation	20 01 01	5
Glass	Glass waste – Personnel of the installation	20 01 02	1.7
Plastic materials	Plastic waste – Personnel serving the facility	20 01 39	13
Metals	Metal Elements – Personnel of the installation	20 01 40	1
Packaging that contains residues or is contaminated with hazardous substances	Packaging containing or contaminated with dangerous substances	15 01 10 *	1.1
Absorbents, filter materials (including oil filters not otherwise specified), Polishing materials, protective clothing contaminated with	Absorbents, filter materials (polishing materials, protective clothing contaminated with dangerous substances)	15 02 02 *	0.3

hazardous substances			
Wooden packaging	Packaging waste – Wood	15 01 03	5.5
Paper and cardboard packaging	Packaging waste – paper and cardboard	15 01 01	0.6
Plastic packaging	Packaging waste – plastic	15 01 02	3.6
Composite packaging	Composite packaging materials	15 01 05	0.055
Waste mixed materials	Household waste – Personnel of the facility	20 03 01	32.5

Radioactive waste

During the CTRF operation, the following types of radioactive waste are estimated [1]:

- Organic fluids: oils from pumps and compressors
- Organic solid-liquid mixture: from maintenance activities to pumps, compressors, motors; Solids: catalyst from catalytic isotope exchange columns; molecular sieves from process gas dryers; ion exchange resins from tritiated heavy water and product water purification systems (detritiated water); metal waste and solid materials from the CTRF building (material and equipment, maintenance / cleaning material, etc.).

The estimated amounts of the main types of radioactive waste are shown in the table 1.4.3.2.

Table 1.4.3.2 Main quantities and characteristics of solid waste and radioactive oils estimated to be radioactive waste generated at CTRF [13] during operation

BSI	System	Equipment location	Type of waste	Quantity (kg)	Frequency
38520	Helium purification	TR03	Oil	15	Once a year
	Helium compressors	TR102	Oil	200	Once a year
	Bellows metal pumps, valves, transducers, tritium monitors	TR03	Solid	300	Once a year
38510	LPCE columns	TR03	Catalyst / Filling (solid)	2700	Every 5 years
	Dryers	TR03	Molecular sieves (solid)	300	Every 5 years
	Degassing column	TR02	Filling (Solid)	40	Unknown
	Water pumps	TR02	Solid	15 kg x 13	One every 10 years
	Water pumps	TR02	Oil	10	8000 hours or every 2 years
	Mechanical filters	TR02	Solid	4	Once a year
38500	Maintenance materials (eg cleaning)	CTRF building	Solid	200	Once a year
38590	LCS Valves / Material Replacement	TR02	solid	50	Every 10 years
38530	TGHSS – GBADS dryers	DR 300, DR 301	Molecular sieves (solid)	21.7 kg x 2pcs	Once a year
38540	ADS	TR02	Molecular sieves (solid)	200	Every 5 years

LCS – Liquid Collection System CTRF, BSI 38590

TGHSS – Tritium Gas Handling and Storage System, BSI 38530
 ADS – Atmospheric Detritification System, BSI 38540
 LPCE – Liquid Phase Catalyzed Isotopic Exchange, BSI 38510
 CDS – Cryogenic Distillation System, BSI 38520

In addition to the wastes in Table 1.4.3.2 solid wastes in the form of spent ion exchange resins result from the operation of ion exchange resin purification systems associated with CTRF operation. For each of the two CANDU units of the plant, a total volume of spent ion exchange resins coming from CTRF systems is estimated at: 1.4 m³ / year [13].

1.4.4 Types, codes and quantities / volumes of waste generated by the project during decommissioning

Non-radioactive waste

The actual decommissioning will be carried out based on a specific decommissioning project, following the environmental impact assessment procedure and the issuance of the decommissioning authorization from CNCAN, which will establish the requirements of the authorities for decommissioning the CTRF installation, after obtaining all the necessary approvals / agreements / authorizations.

The Conceptual Plan for the decommissioning of the CTRF [4], estimated that in a normal operation of the detritiation plant, the total amount of waste from the decommissioning of the CTRF will be approx. 254 t, of which approx. 130 t of non-radioactive waste.

According to the Conceptual Plan of CTRF decommissioning the non-radioactive industrial waste presented in the table 1.4.4.1 will result.

Table 1.4.4.1 Estimated amounts of non-radioactive waste generated during decommissioning

Type of non-radioactive waste	Coding / classification	Quantity / volume
Metallic waste	17 04 07	approx. 130 t
Concrete waste	17 01 01	
Debris waste	17 01 07	

Radioactive waste

In the decommissioning phase, after emptying the installation, the main source of radioactive waste will consist of equipment and installations which, during operation, have been in direct contact with tritium, in the form of tritiated water or tritium gas. Also, at the decommissioning of CTRF will be found approx. 124 tons of radioactive waste resulting from the demolition of the building, as detailed in table 1.4.4.2 [4].

Table 1.4.4.2 Estimated quantities of radioactive waste generated during the decommissioning period

Radioactive waste category	Estimated amount generated
Contaminated concrete	approx. 124 t
Radioactive waste from decommissioning	

In assessing these quantities, radioactive waste resulting from decontamination activities as well as other secondary waste resulting from decommissioning were also taken into account [4].

1.4.5 Waste management program (collection, storage, treatment / recovery, transport and final storage / disposal) in the project stages: construction / installation, operation, decommissioning; radioactive waste generated and how it is managed

1.4.5.1 Construction stage

The quantities of non-radioactive waste were estimated in table no. 1.4.3.1. The management, collection and disposal of non-radioactive waste will comply with the provisions of the applicable normative acts in force, regulatory acts and specific approved and implemented procedures of Cernavoda NPP, detailed in subchapter 1.2.6.

The builder will prepare the detailed waste management plan that will be approved by Cernavoda NPP according to the legal requirements and internal procedures of NPP.

Construction waste such as concrete: mixtures of concrete, bricks, tiles and ceramic materials, earth and stones; fertile earth and rocks resulting from the excavations for the foundations will be managed according to the specific legal provisions and internal procedures of Cernavoda NPP, being temporarily stored in the specially arranged spaces of the site organization and then will be transported to the location established by the building permit by an authorized economic operator.

Hazardous waste such as soil contaminated by diesel spills, oils, etc.; absorbents, filter materials (polishing materials, protective clothing contaminated with dangerous substances); packaging containing residues or contaminated with hazardous substances shall be stored in specially designed premises of the NPP and then taken over by an authorized economic operator for treatment / disposal.

The other types of waste (recyclable, packaging, household) will be managed according to the NPP procedures described in the next subchapter.

As no radioactive materials or radiation sources are used during the construction phase, the Radioactive Waste Management Program does not apply to this stage.

1.4.5.2 Operating stage

Non-radioactive waste management

Non-radioactive waste is all waste that has no detectable free contamination and contact dose rates above the natural background value.

Cernavoda NPP has implemented a system of segregated collection, characterization, classification, and temporary storage of non-radioactive waste before being handed over to authorized economic operators. CTRF activities will be properly integrated and implemented within this system, according to the internal procedure Cernavoda NPP SI-01365-A033 "Management of non-radioactive industrial waste at Cernavoda NPP".

Non-radioactive waste management is carried out in compliance with the provisions of the applicable regulatory documents in force, regulatory acts and specific procedures approved and implemented by Cernavoda NPP, being part of the system implemented and applied by Cernavoda NPP:

- Government Emergency Ordinance no. 92/2021 on the waste regime;
- GD no. 856/2002 on the record of waste management and for the approval of the list of wastes, including hazardous waste with subsequent amendments and supplements;
- Law no. 249/2015 on how to manage packaging and packaging waste;
- Emergency Ordinance 5/2015 on waste electrical and electronic equipment;
- GD no. 1061/2008 on the transport of waste on the Romanian territory,
- The Environmental Permit of Cernavoda NPP, approved by GD no. 84/2019 on the issuance of the environmental permit for the National Company "Nuclearelectrica" – S.A. – NPP Branch – Unit 1 and Unit 2 of the Cernavoda Nuclear Power Plant, SI-01365-AO33 – procedure regarding the management of non-radioactive industrial waste at Cernavoda NPP.

Waste generated in CTRF activities will be collected separately at the place of generation and transferred to owner's spaces specially designed for temporary storage until delivery to economic operators authorized for collection, transport, disposal / recovery. In these spaces, delimited and marked so as to easily identify their destination, the waste is temporarily stored by type and composition.

Non-radioactive waste is managed according to the internal procedure Cernavoda NPP SI-01365-A033 "Management of non-radioactive industrial waste at Cernavoda NPP", which consists of inspecting the labeling, packaging integrity, sampling for tritium and gamma tests and sealing containers (in order to avoid further contamination, until transfer outside the radiological area).

Recyclable, packaging and household waste flows are briefly described below.

Recyclable waste such as iron and steel; metallic waste; wood waste; plastics, insulating materials; polishing and protective clothing, paper and cardboard packaging; wooden packaging; composite packaging; glass waste; paper and paperboard waste (from administrative and office activities); plastic packaging will be stored in the specially arranged spaces of the NPP and then taken over by an authorized provider for their recycling.

Non-recyclable packaging waste (packaging that contains residues or is contaminated with hazardous substances) will be stored in NPP landfills and will be taken over by an economic operator authorized for recovery / treatment / disposal.

Household waste such as (mixed municipal waste), generated from the activity of staff will be temporarily stored in specially designed spaces of Cernavoda NPP and then taken over by an economic operator authorized for disposal (authorized landfill) [1].

Non-radioactive waste of paper, wood, ferrous and non-ferrous metals, lead-acid batteries, plastic are handed over based on service contracts to authorized economic operators for their recovery.

Containers with waste from radiological areas are monitored for the identification of possible contamination and dose rates before being transferred outside the radiological area, either to authorized suppliers for waste collection or for temporary storage in specially designed spaces of Cernavoda NPP. If values above the approved limits (up to which the waste is considered non-radioactive) are detected, such waste is considered radioactive waste and treated according to radioactive waste procedures.

Waste containers are handled with forklifts and equipment specific to these maneuvers. All used lifting equipment is also authorized by ISCIR for use.

The transport of non-radioactive waste containers for temporary storage or transfer to other entities is carried out by electric truck, tractor, truck, authorized for the transport of non-hazardous or hazardous waste (as appropriate), with the appropriate anchoring of the transported products.

In areas approved for the storage of non-radioactive waste in the protected area, there are large containers, identified separately for each type of solid non-radioactive waste collected. After filling, the containers designated for wood, ferrous and non-ferrous metal waste, the waste is transferred to economic operators authorized for recovery / disposal, as appropriate.

The transfer to economic agents authorized for temporary storage, disposal or recovery is made based on a service contract, the transport being performed by the provider with authorized means of transport for the categories of waste transferred. Plastic bags with solid waste are transferred to metal containers, or packaging provided by the authorized service provider, in order to eliminate incidents caused by damage to the bags.

The temporary possession, until the transfer outside the unit, of the non-radioactive waste / expired chemicals is done by Cernavoda NPP (as a waste generator), in specially arranged existing spaces of Cernavoda NPP.

Transports of hazardous waste delivered to authorized economic operators in quantities of more than 1 ton / year (from the same category of hazardous waste) are carried out only after obtaining the shipment / transport approvals from the Environmental Authority within the treatment / recovery / disposal facilities of the service provider, approvals endorsed by ISU Constanța. The

shipments of waste are carried out only accompanied by the transport documents imposed by the specific legislation, GD no. 1061/2008 *on the transport of hazardous and non-hazardous waste on the Romanian territory*.

The control of the storage and disposal of non-radioactive chemical waste is carried out by:

- registration of inputs / outputs by categories and quantities of chemical waste, in records specific to each storage space;
- archiving the forms for recording the transfer of waste and the transport of waste batches, filled in and approved according to the internal procedure of Cernavoda NPP SI-01365-A033 "*Management of non-radioactive industrial waste at Cernavoda NPP*";
- taking representative samples from waste containers for their characterization by physico-chemical tests; keeping counter-tests until the disposal / recovery of the respective waste (for the hazardous ones);
- periodic inspection of temporary storage areas for waste from the installation and application of corrective actions where required;
- contracting transport and waste recovery / disposal services only with authorized providers, after verifying that they meet all legal requirements according to environmental regulations in the field of waste: presentation of a copy of permits, obtaining transport approvals according to the legal procedure;
- verification and approval of the transfer documents by the person responsible for the management of non-radioactive industrial waste of Cernavoda NPP.

The packaging (metal drums and plastic drums) is recovered after emptying the product and used for the same purpose after being reconditioned (if necessary) by painting, restoring the markings (labels) and removing any impurities.

The transfer to the unit of services for recovery / disposal of waste is made in accordance with the regulations on the transport of waste on the Romanian territory and with the laws that regulate waste management.

Collected in dedicated containers, household waste is taken over by authorized economic operators and transported by specific means of transport to eco-friendly landfills.

Radioactive waste management

The management of radioactive waste generated by the project activities will be carried out similarly and in an integrated way with those generated by the activities of U1 and U2.

The radioactive waste resulting from the CTRF operation will consist, for the most part, of: catalyst and packing from LPCE, metallic waste and solid materials, molecular sieves from LPCE dryers, molecular sieves from ADS and TRS dryers, molecular sieves from TGHSS dryers and ion exchange resins. This waste falls into the category of low and medium active solid waste, the radioactive contamination of which consists mainly of tritium (excluding ion exchangers, which will contain corrosion and activation products and / or fission products, depending on the source of the tritiated heavy water fed). This waste will be managed within the radioactive waste management program of Cernavoda NPP.

Radioactive waste must be classified according to its physical and radiological characteristics in order to optimize its processing and storage. Cernavoda NPP will ensure the intermediate storage of radioactive waste under radiological safety conditions and will prepare the waste parcels according to the specific acceptance criteria for the final storage established by the Nuclear Agency and for Radioactive Waste, after the Final Deposit of Low and Medium Active Waste, respectively the Geological Deposit, will be operational.

Appropriate procedures and equipment will be used to ensure proper monitoring, collection, sorting and storage of radioactive waste.

The CTRF will have temporary storage facilities for radioactive waste.

The liquid aqueous radioactive waste generated at CTRF is taken over by the active sewerage system (BSI 71740), Unit 1, which directs this waste in the radioactive liquid waste system of Cernavoda NPP (BSI 79210), Unit 1.

It is forbidden to discharge organic liquid radioactive waste into the Cernavoda NPP drainage system. It will be collected in 220 l stainless steel barrels.

The handling, intermediate storage and transport of organic liquid radioactive waste (oils from pumps and compressors, solvents, others) will be performed in a controlled and procedural manner, according to the existing procedure of Cernavoda NPP.

The handling, transport, intermediate storage of solid radioactive waste will be performed in a controlled manner, according to NPP procedures [89, 90].

The management of these types of radioactive waste is summarized in the following diagram:

General CTRF radioactive waste management scheme

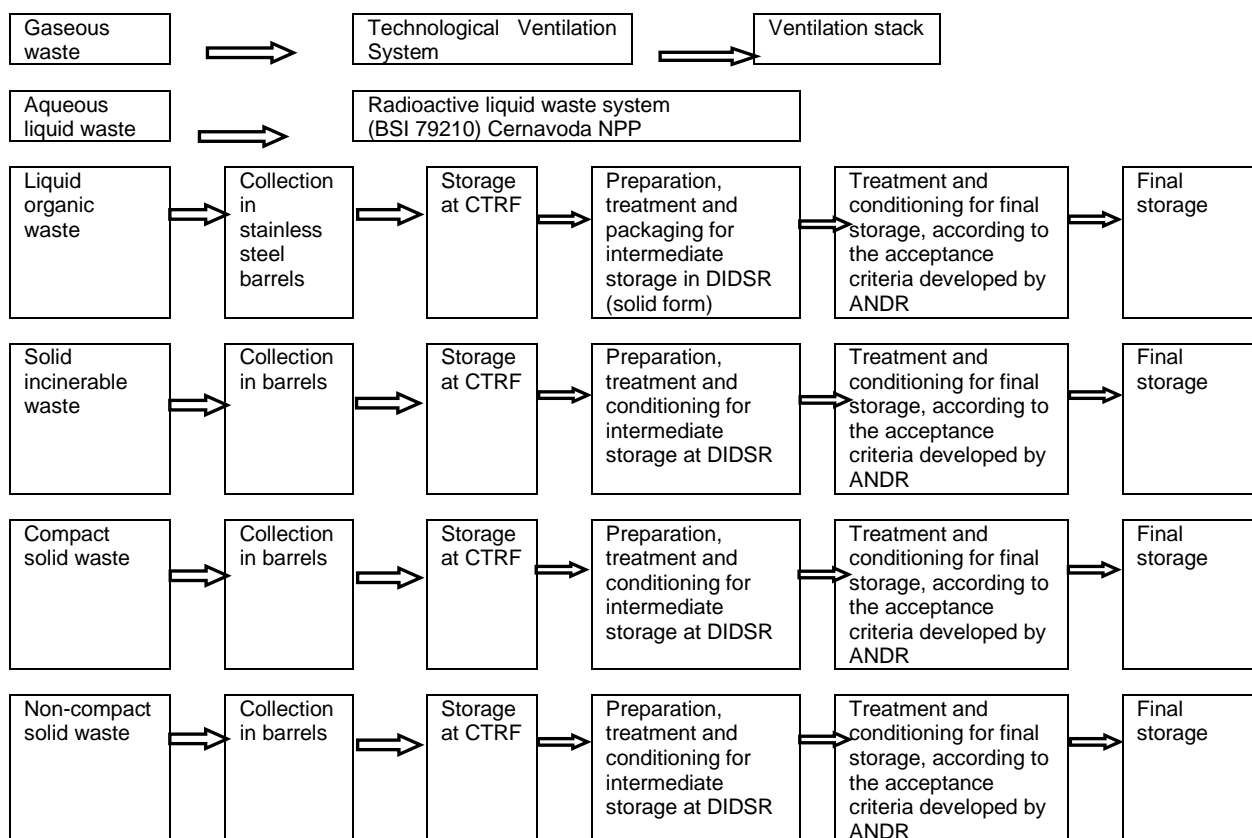

For the management of organic liquid and solid radioactive waste **Temporary storage spaces** will be provided for barrels of radioactive waste resulting from the operation and periodic maintenance of CTRF ready to be transferred for treatment and conditioning according to the control process of radioactive materials Cernavoda NPP [13].

CTRF will include spaces for the collection and temporary storage of radioactive waste intended for short-term storage of packaged liquid organic or solid waste, respectively of barrels of radioactive waste resulting from the periodic operation and maintenance of CTRF, to be transferred to U1 or U2 for characterization and processing, release under the CNCAN authorization regime, if applicable, or transferred to DIDS. The ion exchange resin type waste results from the equipment related to the tritiated heavy water supply system of the installation (HWFS – Heavy Water Feed System located at Cernavoda NPP, Unit 1 and Unit 2); these are managed similarly to those in the plant, respectively they are transported to the storage tanks / containers used for ion exchange resins located in the Services Building in each unit.

Currently, the DIDS existing on site provides the intermediate storage of barrels with radioactive waste in solid form generated by the operation of Units 1 and 2 of Cernavoda NPP. According to

the National Medium and Long-Term Strategy on Waste Nuclear Fuel and Radioactive Waste Management, a Final Low and Intermediate Level Waste Deposit (DFDSMA) will be put into operation by the Nuclear and Radioactive Waste Agency. The commissioning of DFDSMA will allow the transfer of radioactive waste from processed DIDSr in order to meet the acceptance criteria for final disposal and consequently to clear the space in DIDSr.

Interim storage of waste ensures the containment and monitoring of waste with the possibility of recovery for release under the authorization procedure or further processing for transfer to a final landfill.

1.4.5.3 Decommissioning stage

CTRF is an auxiliary installation of the Cernavoda nuclear power plant, designed for a lifespan of 40 years, with the possibility of extending it equivalent to the lifespan of its units. CTRF decommissioning plan will be integrated into the decommissioning plan of the nuclear unit, which will be subject to CNCAN approval [4]. The initial (preliminary) decommissioning plan is developed at the stage of obtaining the CNCAN construction permit, according to CNCAN NDR-07 Norms. See also information presented in Subchapter 1.4.4.

The decommissioning of the CTRF will be in agreement with the decommissioning stages of the other radiological installations of the plant. Thus, for waste collection, at the start of CTRF decommissioning activities, there will be a collection system, with flows adapted to the categories of waste that will result from the planned operations for the decommissioning of this facility.

The waste collected in the cleaning and preparation phase for decommissioning of the installation is similar to the waste resulting from the operational stage and consequently can be managed within the flows specific to the operational stage, and waste resulting from the actual decommissioning stage will be managed according to the waste management program resulting from the decommissioning of the NPP units, in accordance with the provisions of the final decommissioning plan, which is approved by CNCAN, initial information on how to manage radioactive waste will be available in the initial (preliminary) decommissioning plan to be developed at the stage of obtaining CNCAN permits, according to NCN -01 and NSN-22, preliminary plan which is updated every 5 years.

1.4.6 Types and quantities of liquid effluents generated by the project (including effluents, technological waste, cooling water, sewage, treated wastewater, as appropriate), during construction, operation, decommissioning and their management

1.4.6.1 Construction stage

During the construction phase, the category of liquid effluents generated by the project will be represented by domestic wastewater. According to the norm in force I 9-2015 regarding the design, execution and operation of the sanitary installation's afferent to the buildings, MDRAP, during the construction phase (approximately 18 months), wastewater will be generated following the use of sanitary facilities by approximately 100 employees.

The average wastewater flow generated by this number of users is:

$$Q_{\text{max day use}} = 8.07 \text{ m}^3 / \text{day}$$

Respectively

$$Q_{\text{at 12 months use}} = 4,418,325 \text{ m}^3 / \text{construction stage}$$

This domestic wastewater flow will be added to the wastewater generated by personnel serving existing activities in Unit 1, which are gravitationally discharged at Pump Station 7175-SP1 (equipped with 2 + 1 pumps with $Q = 92.5 \text{ m}^3 / \text{h}$, $H = 36 \text{ m}$) located inside the Unit 1 and from here they are evacuated by pumping to the Domestic Water Pumping Station 7175-SP2 (equipped with 3 + 1 pumps with $Q = 80 \text{ m}^3 / \text{h}$, $H = 20 \text{ m}$) located between Units 3 and 4. From SP2 the water is pumped to PS "Valea Cişmelei" of Cernavoda.

Domestic wastewater from Unit 1 is discharged into the sewerage network of the city of Cernavoda, based on the Water Management Modification of Authorization no. 58 / 07.2021, No.

72 of 06.09.2021 for Cernavoda NPP U1 and U2, respecting the maximum limits allowed according to GD188 / NTPA 002/2002 amended by GD no. 352/2005.

Given that no radioactive materials or radiation sources are used during the construction phase, and inside the CTRF building, until the commissioning of the tritium removal facility, the possibility of radioactive contamination is excluded, it is not expected that from the activities carried out in this stage there will be a result in radioactive liquid effluents.

1.4.6.2 Operating stage

During the operation phase, there will be approximately 26 employees who will work in shifts, according to the regulations in force I 9-2015 on the design, execution and operation of sanitary installations related to buildings, MRDPA. Therefore, the quantities of liquid effluents generated by the project from the category of domestic wastewater will decrease significantly reaching a volume of:

$$Q_{\text{max day use}} = 2.90 \text{ m}^3 / \text{day}$$

Respectively

$$Q_{\text{at 12 months use}} = 1,060 \text{ m}^3 / \text{year}$$

The sewerage system of CTRF will be connected to the domestic and rainwater sewerage systems of Unit 1, and the evacuation in the sewerage network of Cernavoda will be carried out in accordance with the authorizations and legislative regulations in force.

Cooling water will not fall into the category of liquid effluents generated by the project. The 2 refrigerating units ensure CTRF continuous, closed-circuit operation [6].

CTRF process effluents

Potentially contaminated CTRF process effluents from the technological area including used water from the fire extinguishing system and the water resulting from the decontamination of the equipment will be collected gravitationally in a sealed tank (with a volume of 6 m³) located in the basement of the CTRF building, from where they will be transferred by pumping to the Radioactive Liquid Waste Management System from Unit 1.

From the sealed tank, potentially radioactive liquid waste is transferred controlled by pumping to the Active Drainage System in the Unit 1 Service Building, from where it is then transferred to the Radioactive Liquid Waste Management System. The volume of the tank and the transfer system were calculated so that it could take over the maximum volume of water that could accumulate and avoid flooding the first basement.

The U1 Radioactive Liquid Waste Management System (consisting of 5 tanks, 50 m³ each, filter / ion exchanger unit – for purification, filters and dilutes if necessary and brings to values below the evacuation limit – and pumps) discharges water from the tanks, in the condenser cooling water discharge channel of Units 1 and 2 of Cernavoda NPP. The discharge of the contents of a tank into the condenser cooling water channel is done in a controlled manner.

1.4.6.3 Decommissioning stage

In the preparatory activities for the decommissioning stage, more precisely in the stage of turning off the installation, a series of liquid effluents from the support systems (D₂O, water, oil, etc.) will result [2], which will be recovered and treated accordingly, pursuant to the provisions of the final decommissioning plan, which will be approved by CNCAN, initial information on how to manage radioactive waste will be available in the initial (preliminary) decommissioning plan to be developed at the stage of obtaining the CNCAN building permit, according to NDR-07, preliminary plan which is updated every 5 years, in accordance with the same regulations.

1.4.7 Composition and toxicity or hazardousness of all liquid effluents produced by the project

The entire radionuclide inventory in the tritium removal facility comes from the heavy water transferred from Units 1 and 2, the moderator systems and the primary heat transfer systems. Whereas, before being transferred to the Tritium removal facility, the tritiated heavy water is purified to the quality parameters required to supply the Catalytic isotope Exchange (LPCE) columns by removing mechanical impurities and retaining radionuclides other than tritium in a purification unit, the premises are created so that the fluids that will circulate inside the installation are contaminated only with tritium. However, the possibility of traces of other radionuclides is not ruled out, in principle, only in the part of the installation where tritiated heavy water (feed fluid) is circulated. However, the concentration levels of these radionuclides are low due to the high efficiency of the purification system, see Subchapter 1.3.1 (HWFS). Normally, the discharge of liquid effluents is made in the Danube, through the Seimeni Canal.

For the discharge of liquid effluents into the Danube – Black Sea Canal, additional measures are implemented, so that the concentration of radioactivity in the canal water complies with the limits established by the legislation in force for drinking water. Administrative measures and monitoring ensure compliance with the legal requirements for drinking water radioactivity (^3H concentration, global alpha activity and global beta activity). The plan of measures for limiting the concentration of radioactivity in the discharged water is presented to the authorities for obtaining permits to switch the discharge route [4].

The composition and toxicity of non-radioactive liquid effluents will be monitored through the Cernavoda NPP's own laboratory and through accredited third-party laboratories.

1.4.8 Liquid effluent management and monitoring program; including the calculation of radionuclide dispersion in surface waters

Monitoring program of the radioactive liquid effluent

Potentially contaminated fluids from the CTRF technological area are collected in the tank located at an elevation of 96 m from where they will be transferred to the liquid effluent collection tanks of Cernavoda NPP, Unit 1. The processing of this waste will be done according to the liquid effluent monitoring program. At the power plant [2].

Aqueous liquid waste is collected and processed within radioactive contaminated wastewater treatment system, which consists of 5 tanks (tank, made of concrete lined with epoxy resin, with a capacity of 50 m³ each, located in the basement of the service building and of collection / transfer piping systems. The contents of a tank are mixed and a sample is taken which will be analyzed in the chemical laboratory of Cernavoda NPP, in terms of pH and radioactivity concentration – by gamma spectrometry and tritium analysis by counting with liquid scintillators.

If the measured values are less than the limits set for discharge, the contents of the tank are discharged into the condenser cooling water channel – the minimum dilution factor is 1: 2900, but normally the discharge is made with a dilution of 1: 7000. During discharge, the effluent is continuously monitored by the liquid effluent monitor which measures the discharged gamma radioactivity and stops the discharge in case the fixed alarm threshold is exceeded. Condenser cooling water is discharged through the Seimeni discharge channel into the Danube, where another dilution takes place.

Discharge of a tank is permitted if it contains less than 0.05% of the annual LDE – gamma activity and 0.5% of the annual LDE tritium, and the estimated total for that month (including previous discharges) is less than 3% of the annual LDE [1]. If the measured values are higher than the limits set for evacuation, the contents of the tank are decontaminated by filtration on columns equipped with ECODEx resins that retain gamma radionuclides and the process is resumed. During the discharge, the MEL (liquid effluent monitor – LEM) continuously collects a sample. The collected sample is analyzed in the dosimetry laboratory and the values are reported [3].

The management of liquid effluent discharges is carried out by following the compliance with the operational limits, established by reference to the derived evacuation limits (LDE) approved by CNCAN.

Thus, for the liquid effluents generated by the two CANDU units of Cernavoda NPP, in operation, LDE for liquid discharges were calculated for each discharge route and each population group considered for liquid discharges in CDMN and Danube respectively. By the calculation methodology proposed by Cernavoda NPP and approved by CNCAN, for each radionuclide, the lowest value of the calculated LDE was selected.

Derived limits for the discharge of radioactive effluents into the environment are set so as to ensure that the dose constraints are respected for the most exposed persons in the population.

For liquid effluents, 3 different locations were established for the representative persons (adult, respectively child 0 – 1 year), depending on the two possible evacuation routes:

CDMN evacuations: - The town of Cernavoda located 2 km from the power plant.

- The city of Constanța only for drinking water, because approximately 40% of its population is supplied with drinking water from CDMN.

Danube evacuations: - The locality of Seimenii Mari, located on the bank of the Danube at approx. 1 km downstream of the discharge point of the condenser cooling water outlet into the Danube.

In addition to the annual evacuation limits, in order to monitor and optimize the control of radioactive evacuations, LDEs have also been approved for shorter periods of time, as follows:

- Quarterly LDEs: 35% of annual LDEs;
- Monthly LDEs: 15% of annual LDEs;
- Weekly LDEs: 6% of annual LDE.

Similar to the effluent emission authorization process applied to the two units of Cernavoda NPP, in the case of CTRF, CNCAN will establish a dose constraint of 10 μSv/year, associated with the operation of the tritium removal facility, which will serve as a basis for establishing the derived evacuation limits for gaseous effluents. Due to the proximity of the CTRF sites, respectively U1 and U2 and the similarity of the effluent discharge installations, it is proposed to use the same models for calculating the derived evacuation limits for the CTRF also.

In the mathematical modeling of the transfer of radionuclides from source to human receptor, the dispersion of radioactive pollutants in the aquatic environment is based on the hypothesis of total dilution of the pollutant in the emissary, before the location where the representative of the population can use the water resource. From the information above, it is observed that in the case of Cernavoda NPP, this hypothesis is fulfilled. Under these conditions, it is defined the transfer parameter P_{02} that binds the concentration of the radionuclide of interest in water (X_2) at a certain location to the discharge flow, $X_0(w)$. This parameter is thus given by the equation:

$$P_{02} = \frac{X_2}{X_0(w)} = \frac{\beta}{D_F \cdot Q_V} \cdot e^{-\lambda_d T} \quad (s \cdot L^{-1})$$

Where:

Q_v = average annual effluent discharge rate (L s-1)

D_F = dilution factor

β = effluent recirculation factor

$\lambda_d = \lambda_r + \lambda_c$ (s⁻¹)

λ_r = radioactive decay constant

λ_c = sediment removal constant

T = transport time from point of evacuation to point of use of water (s)

For conservatism, when no specific data is available for the retention of radionuclide by sedimentation, the value of λ_c is considered $\lambda_c = 0$, and $\lambda_d = \lambda_r$.

The dilution factor, D_F , is the report between the average effluent concentration at the point of evacuation and the average concentration at the point of water use. For evacuation in the Danube – Black Sea Canal, it does not have a significant flow for the necessary dilution of liquid evacuations. Therefore, the D_F will be 1. The main dilution of radioactive liquid evacuations takes place at the evacuation into the Condenser Cooling Water Channel though the Danube.

The recirculation factor β takes into account the increase in the concentration of radionuclide in the effluent, by accumulation, when part of the evacuated water is recirculated. If the evacuated water is not recirculated, $\beta = 1$. For cold periods, when recirculating, $\beta = 1 / (1-f_r)$, with f_r = recirculation fraction.

The transport time from the place of evacuation to the point of use is of 0 (zero) s for Cernavoda and 2.53×10^5 s for Constanta (1 day for transport and 2 days of delay due to water treatment and distribution stations). For evacuations in the Danube (water use by people from Seimeni) the transport time is considered 0 (zero) s for reasons of conservatism. The average annual effluent flow rate of liquid effluent, Q_v , is 5.38×10^4 L s⁻¹ [3].

Using the calculation model above, the dispersion parameters for H-3 and C-14 radionuclides of interest for CTR are estimated (Table 1.4.8.1).

Table 1.4.8.1 Dispersion parameters for H-3 and C-14 radionuclides [3]

Radionuclide	Dispersion parameter P02 (s · L ⁻¹)		
	Cernavoda	Constanța	Seimeni
H-3	1.86E-05	1.86E-05	3.85E-07
C-14	1.86E-05	1.86E-05	3.85E-07

Physico-chemical monitoring program for non-radioactive liquid effluent performed at Cernavoda NPP is carried out according to the provisions of the following regulatory acts:

- Current water management permit – identifying the chemicals that may be present in the evacuated water, the evacuation path and the maximum permitted concentrations;
- The protocol signed with ABADL – which identifies the physico-chemical parameters to be analyzed, the frequency and the sampling points.

The monitoring program consists of two parts:

- the routine monitoring program of the physico-chemical parameters of the evacuated waters
- monitoring program in case of accidental chemical spills

The sampling points shall be set up in such a way as to ensure the representativeness of the samples, both for the influent and for each non-radioactive liquid effluent discharge route.

The sampling points, established by the agreement signed with ABADL, are:

- For Influent:
 - Danube: Hinog water treatment plant, before the supply point of Cernavoda NPP;
 - NPP bridge: the bridge on DJ 223, over the bypass canal.
- For Effluent:
 - Seimeni Bridge: the bridge over the Seimeni drainage canal, where water is evacuated into the Danube;
 - CPPON bridge: the bridge on DJ 223, over the drainage canal, at the hydropower plant, when the water is discharged into the CDMN – Bief II.

The sampling frequencies for the analysis of the various indicators were established by the Protocol signed with ABADL.

The points for measuring the temperature of the influent and the effluents are established by the Protocol signed with ABADL, these being located in relevant points on the banks of the canals (derivation canal Seimeni evacuation canal, CDMN evacuation canal). The temperature is measured daily.

1.4.9 Types and quantities / volumes of gaseous and dust emissions generated by the project (process emissions, radioactive emissions, spontaneous emissions, emissions from burning fossil fuels from stationary sources – Stand-by Diesel generator groups, dust from handled materials, odors), during construction and operation

1.4.9.1 Construction period

The construction phase (18 months) will be a temporary source of gas emissions and dust generated by the activities on site.

Dust emissions will be significantly dependent on the organization of the site and the application of specific measures to reduce dust. The main source will be mainly from construction activities but also from wind erosion on damaged surfaces.

To limit dust emissions, the exposed ground surfaces will be wetting during windy periods.

Non-radioactive gas emissions from the construction period will result from burning fuels in the engines of construction equipment and machinery. These emissions were estimated according to the *EMEP / EEA air pollutant emission inventory guidebook – Publications Office of the European Union, 2019* [9], taking into account the estimated need for equipment, machinery and heavy vehicles used in the construction phase for a period of 18 months.

Emissions of pollutants resulting from the combustion of fuels in the engines of construction equipment and machinery were calculated based on the provisions of Order 3299/2012 – *mobile sources represented by the operation of motorized mobile machinery and equipment, NFR code 1.A.2.f.ii – Non-road mobile sources and equipment (in the industrial field) and mobile sources represented by vehicle traffic at the site of the installation, NFR code 1.A.3.b.ii and NFR code 1.A.3.b.iii.*

The results obtained on the estimated quantities / volumes of emissions from the process are presented in Table 1.4.9.1.2.

Table 1.4.9.1.1 Types / quantities of gaseous emissions generated by the project

Types of gaseous emissions	Source Combustion of fuels in mobile construction machinery and equipment
NO _x kg / duration of the construction stage	4671.8
CO kg / duration of the construction stage	1061.2
SO ₂ kg / duration of the construction stage	439.6
PM ₁₀ kg / duration of the construction stage	131.6
PM _{2.5} kg / duration of the construction stage	131.6

The emissions of pollutants resulting from the combustion of fuels in the engines of construction equipment and machinery are not covered by the GHG authorization of Cernavoda NPP, not coming from stationary sources and will also be local and of short duration.

During the construction phase of the CTRF, there will be emissions of SO₂, NO_x, CO and dust from the flue gases of the equipment used on site and from the transport activity, as well as from the excavation works of the soil.

The equipment that will be operated on site will be technically appropriate, as much as possible the work will be carried out during the day, they will be limited in time, carried out by trained personnel, in compliance with all preventive measures, so that emissions are kept to a minimum in order not to endanger human health and the environment.

Radioactive emissions

During the construction phase, there are no other radioactive emissions, as a result of the implementation of the CTRF project, except for some potential resuspensions of the radioactive contamination from the soil present in the vicinity of Cernavoda NPP.

The results of the environmental monitoring program of Cernavoda NPP confirm the results of the monitoring programs of the environmental authority, indicating that in the area of influence of the plant is not observed the presence of artificial radionuclides gamma emitters having as source emissions from Cernavoda NPP, the only radionuclide indicating a NPP contribution to the soil radioactivity being tritium.

Table 1.4.9.1.2 presents the values measured within the environmental factors monitoring program of Cernavoda NPP, in 2020, for the investigation points on the Cernavoda NPP site closest to the CTRF location area. As the variation in the concentration of tritium in the soil depends not only on the level of emissions from nuclear units, but is significantly influenced by meteorological conditions (winds, precipitation) and excavation depth, it is proposed to take into account the maximum annual average determined in the area of interest for the calculation of tritium emissions from the construction / assembly stage.

Table 1.4.9.1.2 Tritium activity concentration (Bq / kg) measured within the environmental monitoring program of Cernavoda NPP in 2020

Point of investigation	Date	Tritium activity concentration (Bq / kg)	
		Value	Average
Zone DICA – SSL01	22-Apr-2020	16	18
	12-Oct-2020	20	
Protected perimeter of Unit U1 – SSS10	22-Apr-2020	43	27
	13-Oct-2020	11	

Given that the regulations in force provide for a maximum permissible concentration of 10 mg / m³ for dust in the air in the working environment (regulated by the Decision no. 1425/2006 for the approval of the Methodological Rules for the application of the provisions of Law 319/2006 on occupational health and safety), it can be estimated that for a value one hundred times higher than this concentration results in an additional tritium concentration in the air of 30 mBq / m³. This conservative estimate of the local increase in the concentration of tritium in the air as a result of the resuspension of soil particles mobilized by excavations at the CTRF site, shows that it is inappropriate to consider this as a source of radioactive emissions, since its effect is one order of magnitude below the concentration of atmospheric tritium of cosmogenic origin. In conclusion, it is estimated that there are no sources of radioactive emissions into the atmosphere associated with the construction phase of the CTRF.

Spontaneous emissions

By applying the appropriate procedures, respectively spraying / wetting the dust sources, they will be reduced to a minimum and their amount will be insignificant in relation to the natural background.

Odors

There are no sources of odors as a result of the operation or supply of various auxiliary materials or fuels to the Stand-by Diesel generator sets.

1.4.9.2 Operating period

During the operation period, there will be gaseous and dust emissions resulting from the periodic tests (2 hours/month/Stand-by Diesel generator group) for the preventive verification of the availability of the two Stand-by Diesel generator units. To these will be added as before the emissions generated by the fuels of the transport means and other equipment on the premises, the latter being of short duration and will be the result of short distances movement to carry out

punctual activities necessary for the operation of the two nuclear electric units installations and of the auxiliary / related ones.

At this stage of the technological process of tritium removal, radioactive emissions appear that will be discharged to the stack of the CTRF installation.

Non-radioactive gas emissions

The operation of the 2 Stand-by Diesel generator groups, will generate emissions of particles and combustion gases of diesel, mainly Nox, CO, SO₂ and dust in the short term. Order 3299/2012 [10] – “Activities in the category of NFR code 1.A.4 Burning in low power stationary sources” and EMEP / EEA 2019 [9] were used to assess emissions.

The results obtained regarding the estimated quantities / volumes of emissions from the combustion of fossil fuels from stationary sources – Stand-by Diesel generator groups, are presented in table 1.4.9.2.1.

Table 1.4.9.2.1 Estimated missions from burning fossil fuels from stationary sources – Stand-by Diesel generator groups

	Nox kg/h	SO ₂ kg/h	CO kg/h	PM ₁₀ kg/h	PM _{2,5} kg/h
Flow	10.260	1.089	1.555	0.466	0.390

These emissions will exist only in the short test periods (2 hours/month), the flow values being maximum, calculated by the methodology below, taking into account the physico-chemical parameters established by national lists by fuel category.

The fuel supply of the CTRF Diesel tanks will be made during the supply process related to the other combustion installations in the CNE, without the need to supplement the transport, as there is no need to supplement the transport, basically will not be an additional contribution of emissions from transport.

The calculation of annual emissions for the recording of greenhouse gas emissions leads to a maximum value of around 395 t CO₂/year, resulting from the operating hours for operational testing of the 2 Diesel-generator sets, which will come into effect after the commissioning of the objective. These estimates are to be included in the next revision of the GHG authorization of Cernavoda NPP Branch, according to the applicable provisions.

The calculation used to estimate the CO₂ emissions related to the EU-ETS installations (diesel groups) is the one applied by Cernavoda NPP for the other EU-ETS installations located on the Cernavoda NPP site, regulated by the greenhouse gas emissions authorization no.38/25.01.2021.

Spontaneous emissions / dust generated by the project

There are no significant dust as a result of the operation or supply of various auxiliary materials or fuels to the Stand-by Diesel generator groups.

Odors

There are no sources of odors as a result of the operation or supply of various auxiliary materials or fuels to the Stand-by Diesel generator groups.

During the CTRF operation period, the only possible sources of direct emissions of non-radioactive toxic substances into the environment are the Stand-by Diesel generator groups (according to Chapter 1, Subchapter 1.4.10, SO₂, NO_x, CO and dust emissions are generated by them).

Stand-by Diesel generator groups will have a limited operation (2 hours / month for test periods/ Stand-by Diesel generator group). In case of incident, by losing the connection to the mains, the Stand-by Diesel generator group will operate for a longer period.

In view of the estimated period of operation of the Stand-by Diesel generator groups, it can be considered that those quantities of emissions in the stack do not present a danger to human health and the environment.

Radioactive emissions

In the case of the CTRF installation, the project creates the conditions for the tritiated heavy water transferred from the technological installations of units 1 and 2 of Cernavoda NPP to be purified, in terms of radionuclide content (other than tritium), by retaining them on ion exchanging resins. This way, the fluids circulated through the CTRF installation will contain, as radioactive contaminants, mainly tritium and traces of radionuclides specific to the primary heat transfer system, or the CANDU moderating system. With the exception of tritium, the presence of other radionuclides is virtually excluded in CTRF radioactive gas emissions. Based on the maximum projected CTRF emissions (50 TBq / year) and taking into account the technical characteristics of the ventilation system, the average concentration of tritium in the gaseous effluent can be calculated.

The results of the evaluations for the average levels of tritium activity concentrations in the radioactive gas emissions for the normal operation of the CTRF installation and the U1 and U2 units from Cernavoda NPP are presented in table 1.4.9.2.2.

Table 1.4.9.2.2 Results of the evaluations for the average levels of tritium activity concentrations in gaseous radioactive emissions for the normal operation of CTRF installations and U1 and U2 units from Cernavoda NPP

Source name	Polluting form	Emission fraction	Activity flow (TBq / h)	Evacuated gas flow (m ³ / h)	Annual tritium emission (TBq)	Contribution to activity concentration (kBq / m ³)	
CTRF stack	DT / HT	34%	2.13E-03	55000	17	18.4	LDE not yet authorized
	DTO	66%	4.13E-03	61000	33	35.6	
U1 stack	DTO	~ 100%	6.33E-02	158830	506	398.5	3950 TBq / year – LDE for HTO corresponding to a dose constraint of 52.5 µSv / year
U2 stack	DTO	~ 100%	5.76E-02	153630	461	374.9	

Planned emissions

During the construction period of the CTRF, the planned radioactive emissions from stacks U1 and U2 fall within the limit of 3950 TBq / year / unit – LDE for HTO corresponding to a dose constraint of 52.5 µSv / year / unit. During the CTRF operation period, a value corresponding to a dose constraint of 10 µSv / year is added to them.

The planned gaseous emissions are discharged by means of specially designed systems with the aim of ensuring their best possible dispersion, in order to reduce the level of concentration in the area of influence of the installation. The only risk associated with CTRF effluent emissions is radiological, but the maximum effective dose, estimated for the representative person in the population, will be less than 0.7 microSv / year (see subchapter 4.2), which means that these emissions have a very low degree of danger.

1.4.10 Methods of collection, treatment and disposal of emissions

In order to ensure the containment of potential contaminants, inside the technological spaces of the CTRF, as well as for the collection of possible releases of radioactivity from the installations, the CTRF building is equipped with a series of ventilation systems, as follows [1]:

- an S1 ventilation system, in the area of technological installations (area with potential for contamination and / or explosion – area with hydrogen):

- an S2 ventilation system, in the area of auxiliary systems (area without hydrogen, approximately 45,000 m³ / h);
- an S3 ventilation system in the electric battery chamber (approximately 3 000 m³ / h);
- an S4 ventilation system, in the area occupied by the operating personnel (approximately 1500 m³ / h);
- an S5 ventilation system in the helium compressor chamber (approximately 15,000 m³ / h);
- an S6 ventilation system in the air compressor chamber (approximately 2000 m³ / h).

The discharge into the atmosphere of the effluents from the ventilation systems S1, S2 and S3 is carried out through CTRF installation stack, with the following characteristics [1]:

- Stack height: 50 m
- Inner diameter of the stack: approx. 1.7 m
- Stack section: approx. 2.3 m²
- Evacuation flow: 103,000 m³ / h = 28.6 m³ / s
- Evacuation speed: approx. 12.4 m / s

Exhaust flows are designed to ensure the efficient evacuation of hydrogen from the building, in order to prevent the accumulation of hydrogen in the enclosure, therefore, the potential danger of the formation of explosive concentrations [1].

The S4, S5 and S6 ventilation systems circulate clean air, without any danger of contamination, its evacuation being done directly outside the building.

At the same time, inside the CTRF building are located a series of systems with the role of tritium retention or recovery, described below [1].

ADS atmosphere detritiation system – with the role of decontamination (tritium removal) of the air by recovering vapors from the area where the tritiated heavy water processing / storage equipment is located, when the tritium concentration in the air exceeds the predetermined thresholds, situations that may occur in case of accidental leaks or in case of damage. The principle of operation of the atmosphere detritiation system is the evacuation of air from the technological zone through an installation in which D₂O / DTO / H₂O vapors are adsorbed in a desiccant mass. Tritium and hydrogen in gaseous form are catalytically oxidized to tritiated water, followed by condensation of tritiated water vapor and drying of gaseous effluent on the molecular sieve. In the catalytic recombiner, 99.9% of the hydrogen isotopes are catalytically oxidized to tritiated water. Less than 0.1% of tritium gas will not be oxidized. The air thus treated is recirculated to the rooms where the increase in tritium concentration has been detected. A hydrogen detector is provided on the ADS supply circuit to prevent an explosion in the event of system operation, by accumulating hydrogen in the system supply line.

TRS tritium retention system- has the role of ensuring the recovery of tritium and deuterium from all processes involving waste gas streams and purge gases generated during normal operation, maintenance activities (purging and evacuation of equipment) and / or the start of process systems. The mode of operation of the TRS system is of the stand-by type, which enters normal operation at the time of execution of maintenance operations, commissioning, planned shutdowns or in case of emergency. The TRS tritium retention system has the ability to process tritium deuterium from technological systems and aspirated contaminated air from various locations where maintenance operations are performed simultaneously and independently.

For the 2 Stand-by Diesel generator groups there will be discontinuous emissions, of short duration (2 hours / month) and reduced in value. They will be evacuated through a stack that will be 4 meters high above the CTRF building.

1.4.11 Gaseous effluent management and monitoring program

Gaseous radioactive effluent

U1 and U2 radioactive effluent monitoring program is to be expanded to include CTRF discharges. The doses collected by the population will be estimated based on the tritium emissions of CTRF, through the same calculation models that are applied for Units 1 and 2 of Cernavoda NPP and approved by CNCAN.

Verification of compliance with the Derived Emission Limits will be done by monitoring the gas emissions in the stack. According to the regulatory requirements, the Derived Emission Limits will be established by the authorization applicant in consultation with an expert accredited by CNCAN in the field of radiation protection and approved by CNCAN within the authorization process. The measurement of tritium concentration in the evacuated air will be done both in real time and by sampling and subsequent measurement in the laboratory. Thus, for the control and limitation of emissions will be installed [1]:

- A tritium monitor in the air, with an ionization chamber or proportional counter, to provide real-time information on tritium discharges to the stack;
- Two tritium collectors in the air provided with the possibility to discriminatively collect tritium in both vapor (HTO) and gas (HT) form. The samples thus taken will be analyzed in the dosimetry laboratory of the plant to determine the concentration of tritium in the gaseous effluents released into the environment;
- A flow meter for measuring the flow of air discharged into the environment through the stack of the ventilation system. The flow meter will be equipped with an electronic integrator to determine the volume of air released in different periods of time.

Representative air samples will be taken continuously from the dispersion stack, and the tritium concentration in the air will be determined, both globally and discriminatively for the form of water vapor (HTO) and for the form of gas (HT).

The effluent samples will be collected by the CTRF operating staff and analyzed by the Cernavoda NPP Dosimetry Laboratory. Monitoring and reporting of radioactive effluents related to the operation of the NPP will also include data from the CTRF.

All equipment and apparatus that will be used in monitoring radioactive discharges to the CTRF will be certified according to the legal provisions, and the working, calibration, testing, maintenance and metrological verification procedures will be rigorously documented and approved by the responsible factors, including the relevant authorities.

The results of monitoring the radioactivity of effluents discharged into the air are compared with the derived emission limits, which are calculated in accordance with the requirements of the CNCAN Norms, limits that are approved by CNCAN in the commissioning phase authorization process.

Non-radiological gaseous effluents

As the emissions from the 2 Stand-by Diesel generator groups will be discontinuous and short-lived and will be integrated in the Authorization on greenhouse gas emissions of the plant, the monitoring of greenhouse gas emissions will be performed by the NPP based on the monitoring plan approved by the National Agency for Environmental Protection, an integral part of the GHG Authorization. The monitoring report shall be submitted in the first quarter of each year and shall contain the results of the monitoring of emissions generated in the year preceding the reporting.

1.4.12 Characteristics of atmospheric emission sources, as well as their characteristics (stack height, emission velocity and temperature, etc.)

The CTRF installation is designed so that all technological losses are collected inside it. The air intake, collection and evacuation system is designed to reduce the risk of radiological hazards (tritium in the air) both in the air in the technological areas and in the area occupied by the operating personnel (clean area) inside the CTRF installation.

Emissions planned to result from the technological tritium removal process will be evacuated to the CTRF stack.

The project aimed at creating a stack for the evacuation of gaseous effluents from the CTRF to ensure a dispersion similar to that of the stacks from the nuclear units at the Cernavoda NPP.

Table 1.4.12.1 presents the constructive and functional characteristics of the ventilation stacks of the CTRF installation and of the two CANDU units, in operation at Cernavoda NPP.

Table 1.4.12.1 Construction and functional characteristics of ventilation stacks

Name	Consumption/ production	annual work time (hours)	Pollutants	Height (m)	diameter inside the top of stack (m)	Speed, (m/s)	Temperature (° C)	Flow volume / mass flow (m ³ / s)
CTRF stack	320 t / year heavy water	8000	DTO DT	approx. 50	1.7	approx. 12.6	20-30	28.6
U1 unit stack	706.5 MWe installed power	8000	DTO	50.3	2.3	8.9 average	45	44.12
U2 unit stack	706.5 MWe installed power	8000	DTO	50.3	2.3	8.9 average	45	42.68

1.4.13 Dispersion factors for gas from the Stand-by Diesel generator groups

For the calculation of the dispersion factors for the gases from the Stand-by Diesel generator groups, the parameters from Table 1.4.13.1 were taken into account.

Table 1.4.13.1 Parameters used in the calculation of dispersion factors for gases from Stand-by Diesel generator groups

Item no.	Parameter	Value	Source	Comment
1	Wind speed at the earth's surface	>6 m/s	Meteorological study regarding the location of Cernavoda NPP, 2019	Taken from the compass rose
2	The time of day	12 hours	-	We opted for maximum turbulence
3	Solar radiation	Moderate	-	It was estimated based on data from the Meteorological Study on the location of Cernavoda NPP, 2019
4	Atmospheric stability class	D	Calculated according to the formula	The formula took into account item no. 1, 2 and 3
5	Environment	Industrial	-	The presence of nearby buildings reflects the conditions of the urban environment
6	Anemometer height	10 m	Meteorological study regarding the location of Cernavoda NPP, 2019	-
7	Wind speed at anemometer height	7 m/s	Meteorological study regarding the location of Cernavoda NPP, 2019	-
8	The height of the stack	9 m	According to the information provided by NPP	-
9	The speed of the wind at the height of the stack	6.82 m/s	Calculated according to the formula	-
10	Stack diameter	0.4 m	According to the information provided by NPP	-
11	Gas temperature at the exit of the stack	810 K	According to the information provided by NPP	-
12	Atmospheric temperature	295.15 K	Meteorological study regarding the location of Cernavoda NPP, 2019	Average temperature

The input data presented in Table 1.4.13.1 were used as follows:

- for calculating atmospheric stability: wind speed, time of day (day, night) and type of insolation;
- for calculating the wind speed at the level of the stack: the category of atmospheric stability, the environment (urban, rural), the height of the anemometer, the wind speed at the level of the anemometer, the height of the stack;
- for calculating the height of the pollutant layer: stack diameter, pollutant outlet speed, pollutant outlet temperature and ambient temperature;
- for calculating the dispersion parameters (on y and on z), the distance on x;
- for calculating the concentration of pollutants at different distances, the rate of emission at the stack output, the distance on the y axis and the distance on the z axis. (<https://www.wkcgroupp.com/tools-room/online-air-dispersion-model/>).

Following the calculation of the concentrations of different pollutants at different distances, the data in table 1.4.134.2 resulted. Concentrations were calculated based on emissions from the combustion of fossil fuels from stationary sources - Diesel generator (Table 1.4.9.2.1), established in accordance with Order 3299/2012 [10] - „Activities in category NFR code 1.A.4 Burning in low power stationary sources" and EMEP / EEA 2019 [9].

Table 1.4.14.2 Concentrations calculated at an average ambient temperature of 22 ° C, average wind speed > 6 m / s, at 0 m from the ground (1 diesel generator in operation)

Distance (Km) \ Concentrations of gas released (µg / m ³)	0.2	0.5	0.8	1	1.5	2	5	8	10	15	20	25	30
NO _x	149.01	27.6	11.82	7.99	4.01	2.52	0.65	0.35	0.27	0.16	0.12	0.09	0.08
SO _x	15.82	2.93	1.25	0.85	0.43	0.27	0.07	0.04	0.03	0.02	0.01	0.01	0.01
CO	22.58	4.18	1.79	1.21	0.61	0.38	0.1	0.05	0.04	0.02	0.02	0.01	0.01
PM ₁₀	6.77	1.25	0.54	0.36	0.18	0.11	0.03	0.02	0.01	0.01	0.01	0	0
PM _{2.5}	5.66	1.05	0.45	0.3	0.15	0.1	0.02	0.01	0.01	0.01	0	0	0

Table 1.4.13.3 Concentrations calculated at an average ambient temperature of 22°C, average wind speed > 6 m / s, at 0 m from the ground (2 diesel generators in operation)

Distance (Km) \ Concentrations of gas released (µg / m ³)	0.2	0.5	0.8	1	1.5	2	5	8	10	15	20	25	30
NO _x	298.02	55.2	23.64	15.98	8.02	5.04	1.3	0.7	0.54	0.32	0.24	0.18	0.16
SO _x	31.64	5.86	2.5	1.7	0.86	0.54	0.14	0.08	0.06	0.04	0.02	0.02	0.02
CO	45.16	8.36	3.58	2.42	1.22	0.76	0.2	0.1	0.08	0.04	0.04	0.02	0.02
PM ₁₀	13.54	2.5	1.08	0.72	0.36	0.22	0.06	0.04	0.02	0.02	0.02	0	0
PM _{2.5}	11.32	2.1	0.9	0.6	0.3	0.2	0.04	0.02	0.02	0.02	0	0	0

The dispersion coefficients have been calculated and are shown in Table 1.4.13.4.

Table 1.4.13.4 Dispersion coefficients for pollutants taken into account under the conditions described above (1 diesel generator in operation)

Pollutant / Distance (Km)	0.2	0.5	0.8	1	1.5	2	5	8	10	15	20	25	30
NO _x (10 ⁻⁶ * s/m ³)	52.284	9.684	4.147	2.804	1.407	0.884	0.228	0.123	0.095	0.056	0.042	0.032	0.028
SO ₂ (10 ⁻⁶ * s/m ³)	52.298	9.686	4.132	2.810	1.421	0.893	0.231	0.132	0.099	0.066	0.033	0.033	0.033
CO (10 ⁻⁶ * s/m ³)	52.275	9.677	4.144	2.801	1.412	0.880	0.232	0.116	0.093	0.046	0.046	0.023	0.023
PM ₁₀ (10 ⁻⁶ * s/m ³)	52.300	9.657	4.172	2.781	1.391	0.850	0.232	0.155	0.077	0.077	0.077	0.000	0.000
PM _{2,5} (10 ⁻⁶ * s/m ³)	52.246	9.692	4.154	2.769	1.385	0.923	0.185	0.092	0.092	0.092	0.000	0.000	0.000

Table 1.4.13.5 Dispersion coefficients for pollutants taken into account under the conditions described above (2 diesel generators in operation)

Pollutant / Distance (Km)	0.2	0.5	0.8	1	1.5	2	5	8	10	15	20	25	30
NO _x (10 ⁻⁶ * s/m ³)	104.57	19.37	8.295	5.607	2.814	1.768	0.456	0.246	0.189	0.112	0.084	0.063	0.056
SO ₂ (10 ⁻⁶ * s/m ³)	104.6	19.37	8.264	5.62	2.843	1.785	0.463	0.264	0.198	0.132	0.066	0.066	0.066
CO (10 ⁻⁶ * s/m ³)	104.55	19.35	8.288	5.603	2.824	1.759	0.463	0.232	0.185	0.093	0.093	0.046	0.046
PM ₁₀ (10 ⁻⁶ * s/m ³)	104.6	19.31	8.343	5.562	2.781	1.7	0.464	0.309	0.155	0.155	0.155	0	0
PM _{2,5} (10 ⁻⁶ * s/m ³)	104.49	19.38	8.308	5.538	2.769	1.846	0.369	0.185	0.185	0.185	0	0	0

The graphs in Figure 1.4.13.1 and 1.4.13.2 show the spatial distribution of the dispersion coefficients depending on distance, under the conditions presented above, for the pollutants taken into account.

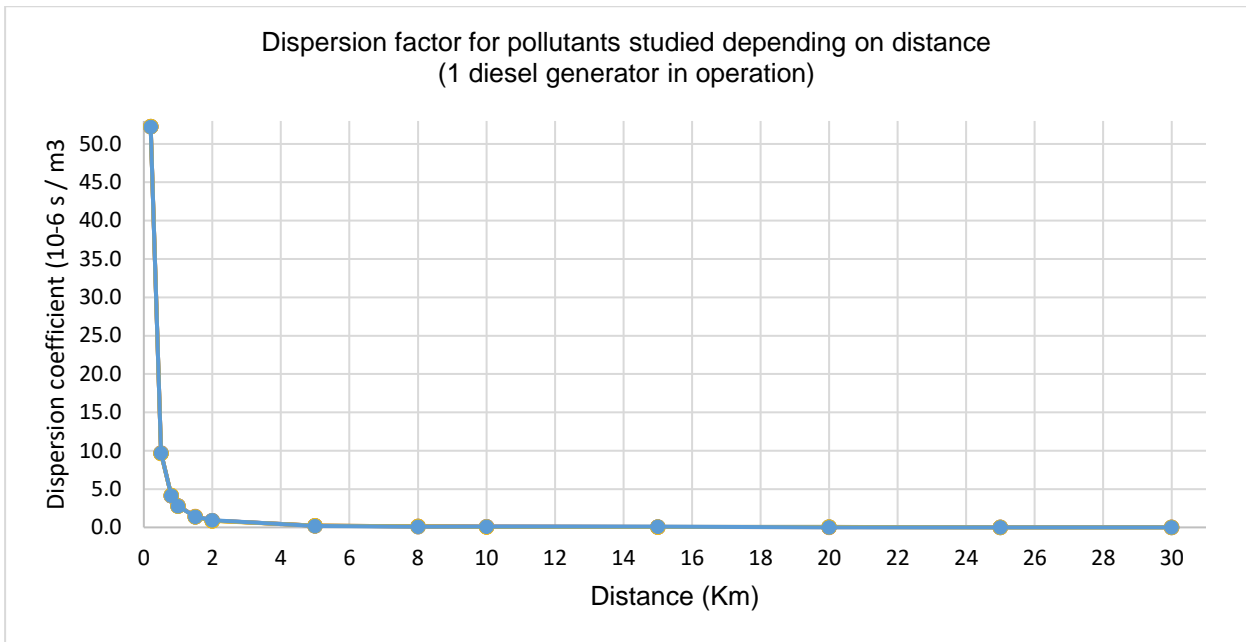

Figure 1.4.13.1 Distribution of the dispersion coefficient according to the distance from the stack at ground level (1 Diesel generator in operation)

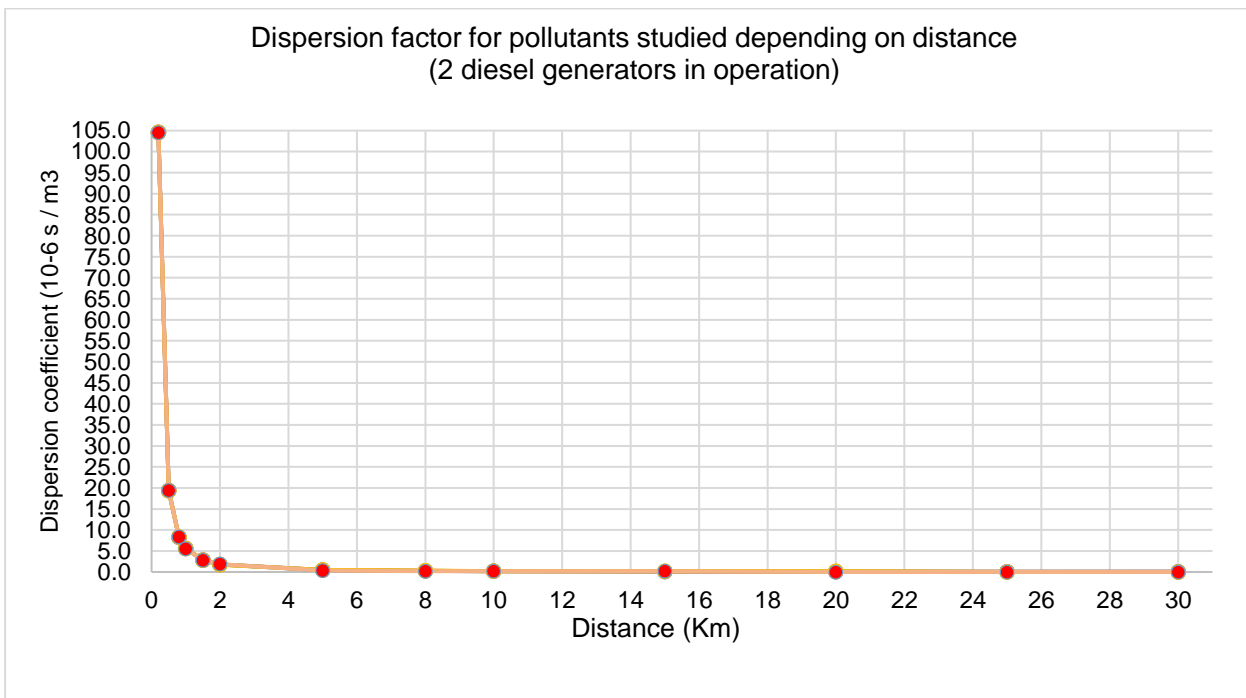

Figure 1.4.13.2 Distribution of the dispersion coefficient according to the distance from the stack at ground level (2 Diesel generators in operation)

1.4.14 Dispersion factors for radionuclides released into the atmosphere

Norms regarding meteorological and hydrological measurements at nuclear installations (NSR-24), approved by CNCAN Order 361/2004, respectively Norms regarding the calculation of the dispersion of radioactive effluents discharged into the environment by nuclear installations (NSR-23), approved by CNCAN Order 360/2004, are the regulatory documents setting out the minimum requirements for hydrological and meteorological assessments of the dispersion of radioactive pollutants in the vicinity of nuclear or radiological installations. According to these documents, it is recommended to use a Gaussian model based on the Canadian standard (CSA1991) and

which is in accordance with EU practice (implemented in the PC CREAM calculation code) for the evaluation of dispersion. The model is useful in the case of a flat, horizontal, homogeneous terrain with few obstacles.

Dispersion factors at a coordinate receptor point (x, y) represent the ratio of the average radionuclide concentration measured at the receptor (Bq / m³) to the emission rate at the stack (Bq / s).

The concentration (C) [Bq / m³] of a radioisotope in the air, at a certain distance from the point of emission, is calculated as follows:

$$C = K_a \times Q$$

where Q is the source emission rate of the respective radioisotope (Bq x s⁻¹)

and K_a is the atmospheric dispersion factor (sx m⁻³).

Currently, in accordance with the methodology approved by the regulatory body for the control of CNCAN nuclear activities, for the calculation of the Derived Evacuation Limits corresponding to the operation of Cernavoda NPP, the value of the atmospheric dispersion factor of 5.25 x 10⁻⁷ s / m³ was used, the maximum value predicted by the modeling indicated above.

The calculations made with the help of the PC-CREAM code show that, under the specific conditions of the Cernavoda NPP site, the average dispersion factor for the H-3 radionuclide reaches a maximum at a distance of less than 500 meters from the ventilation stack, having a value of 3, 5 x 10⁻⁷ s / m³ (when the most unfavorable dispersion parameter set is used).

In the figure 1.4.15.1 the results of the simulation of the atmospheric dispersion of tritium are presented, in the specific conditions of Cernavoda NPP, using the PC-CREAM 08 program.

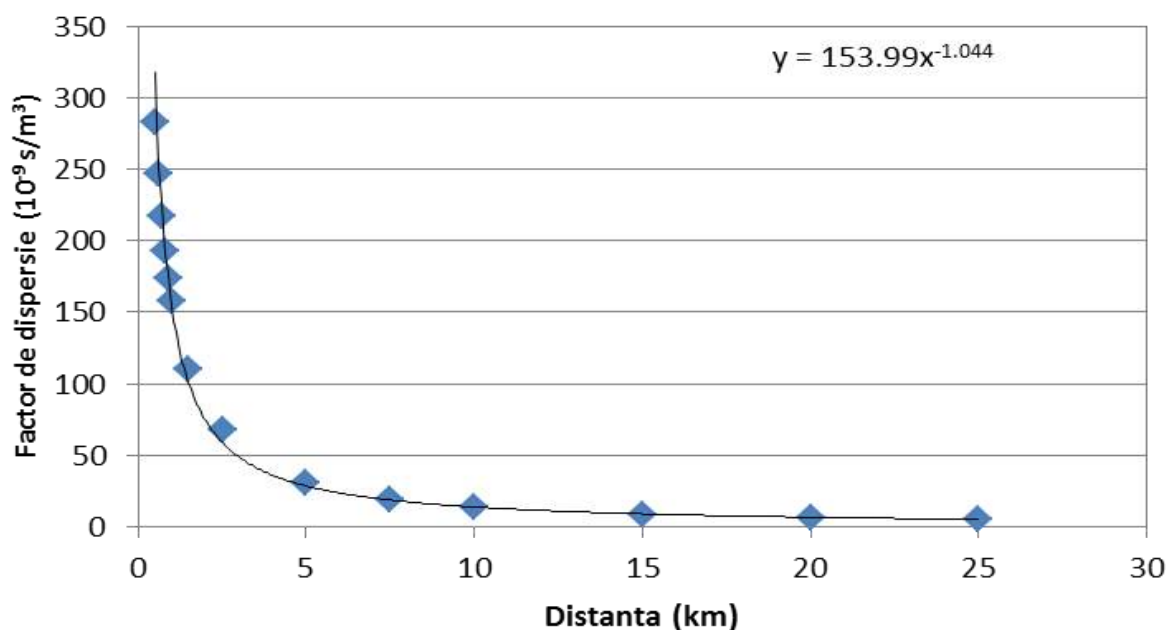

Figure 1.4.14.1 Simulation of atmospheric dispersion of tritium

(*Factor de dispersie= dispersion factor / Distanta= distance)

Other studies performed before this analysis showed that, in terms of tritium dispersion in the vicinity of the source, numerical simulations with algorithms based on the Gaussian model are not validated by experimental determinations, they do not meet strict validation criteria (discrepancy less than 200%, for at least 67% of the compared data sets). However, the values provided by the model are higher than those calculated from the monitoring data, which makes their application conservative.

Consequently, through the screening study [3] it is proposed to use the dilution factors obtained from the data provided by the Radioactive Effluent Monitoring Program and respectively by the Environmental Radioactivity Monitoring Program of Cernavoda NPP. Empirical values of dispersion factors also include the background level.

In table 1.4.14.1 the values of the dispersion factors calculated starting from the monitoring data from the period 2006-2018 are presented, for the air radioactivity monitoring locations from the environmental monitoring program from Cernavoda NPP.

Table 1.4.14.1 The values of the dispersion factors

Location	Distance (km)	Dispersion factor (10^{-9} s / m ³)													
		2006	2007	2008	2009	2010	2011	2012	2013	2014	2015	2016	2017	2018	
ADI-12	0.2	250	255	577	193	786	582	640	599	565	397	243	207	616	
ADI-13	0.5	115	271	481	245	711	323	473	666	681	422	163	152	587	
ADI-11	0.8	58	84	144	60	304	78	164	146	146	126	77.5	38.6	176	
ADI-05	1.5	57	81	95	73	130	77	148	82	117	123	37	28	145	
ADI-06	1.5	24	42	47	35	91	39	36	-	-	-	-	-	-	
ADI-08	2.5	25	77	93	65	180	45	148	124	116	72	29	25	111	
ADI-09	8	18	46	25	21	74	21	40	20	35	21	11	7	43	
ADI-04	10	21	17	20	18	83	34	26	21	28	16	8	10	43	
ADI-02	10	19	18	37	2.3	67	39	34	26	52	26	19	19	43	
ADI-10	11	9	10	13	8	38	9	65	12	35	10	9	3	18	
ADI-07	19	-	-	-	-	-	-	69	15	21	10	7	5	28	
ADI-03	20	-	-	-	-	-	-	69	30	43	26	19	13	25	
ADB-01	25	3	8	16	9	48	19	25	12	22	12	8	4	21	

The location of the tritium level monitoring points in the environment is shown in the figure 1.4.14.2.



Figure 1.4.14.2 Location of investigation points for tritium concentrations in the air according to the environmental radiological monitoring program by Cernavoda NPP

In the table 1.4.14.2 the statistical processing of the set of values for the empirical dispersion factors in the monitoring locations is presented.

Table 1.4.14.2 Statistical analysis of the set of values for the empirical dispersion factors in the monitoring locations

Location	Distance (km)	Dispersion factor ($10^{-9} \text{ s} / \text{m}^3$)		
		Environment	Maximum	Std. dev.
ADI-12	0.2	455	786	203
ADI-13	0.5	407	711	212
ADI-11	0.8	123	304	71
ADI-05	1.5	92	148	39
ADI-06	1.5	45	91	22
ADI-08	2.5	85	180	49
ADI-09	8	29	74	18
ADI-04	10	27	83	19
ADI-02	10	32	67	15
ADI-10	11	18	65	17
ADI-07	19	22	69	22
ADI-03	20	32	69	19
ADB-01	25	16	48	12

From the analysis of the above data it can be seen that the values of the dispersion factor fluctuate quite strongly over time, but they have never reached values above the level of $5.25 \times 10^{-7} \text{ s} / \text{m}^3$ in locations outside the area of exclusion. For this reason, it is recommended that the use of this conservative dispersion factor be continued in population exposure assessments (application of the model for the calculation of derived release limits in the environment).

In the figure 1.4.14.3 the variation with distance of the empirical atmospheric dispersion factors is presented, determined based on the monitoring data from 2006-2018.

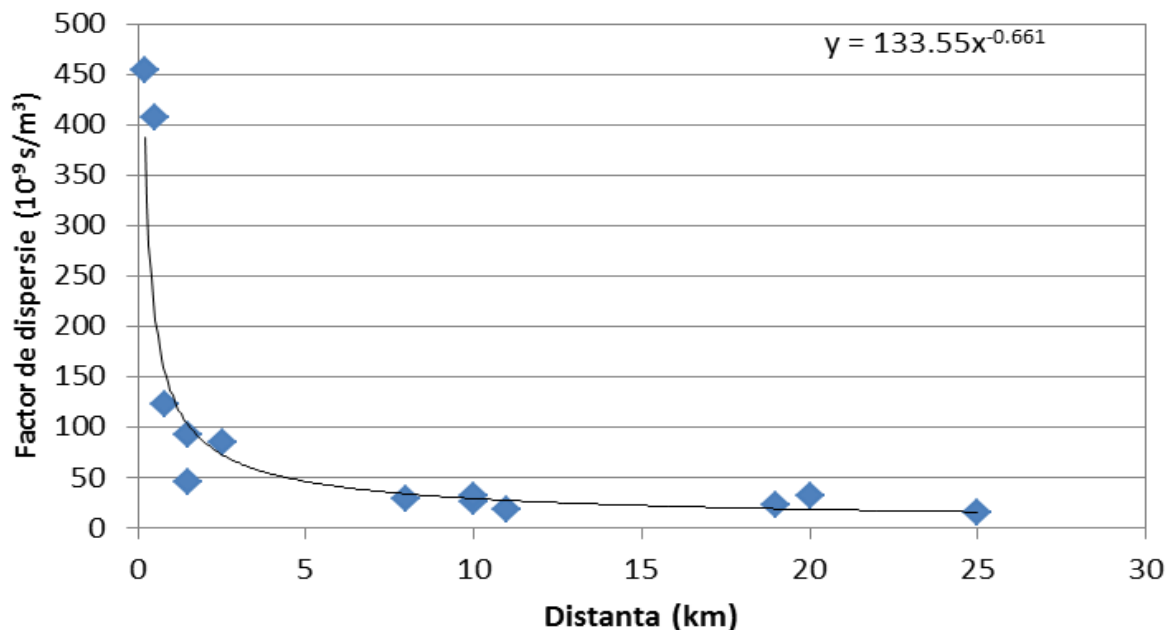

Figure 1.4.14.3 Distance variation of empirical atmospheric dispersion factors, determined based on the monitoring data from 2006-2018

(*Factor de dispersie= dispersion factor / Distanța= distance)

1.4.15 Noise sources from the project

The noise sources related to the tritium removal installation will be associated with the activities carried out on the NPP platform and on-site road transport [1].

The SR 10009-2017 standard stipulates that the permissible limit of the noise level at the limit of the functional space "Industrial premises and spaces with activities assimilated to industrial activities" is 65 dB (A).

The noise sources on the territory of the plant are located, for the most part, at a distance of at least 20 m from the boundary of the enclosure (the fence that borders the territory of the plant). Forecasted noise levels are at least 3 dB (A) lower than the 65 dB (A) limit imposed by law.

Noise sources during the construction phase

At this stage, the noise will come from the traffic of heavy vehicles, dump trucks, concrete mixers, trailers for the on-site transport of heavy machinery, aggregates and various moving components. In addition to the noise produced by motor vehicles, the noise produced by the running of machinery on the access roads of the site will be added.

Another source of noise will be the operation of heavy equipment (bulldozers, excavators, compactors) which will include the noise generated by their engines.

Also, handling the equipment on site, loading and unloading operations will be another source of noise.

Quantification of noise sources in the construction phase

For this stage, there are no details on the elements of the construction equipment that will be used.

Therefore, the quantification of the noise sources at this stage was done based on other similar projects and is not expected to exceed a sound power level of 120 dB. Based on this assumption, the noise level resulting from 500 m of construction activities would not exceed 58 dB LAeq.

Noise sources during operation

During the operation phase, the noise sources will be represented by the pumps, agitators and the ventilation and air conditioning equipment (HVAC) in operation and, where applicable, from Stand-by Diesel generator groups.

Quantification of operating noise sources

The location of the CTRF is located in an area where the noise level at the enclosure is approximately 55 dB (A).

Due to the equipment included in the CTRF, a contribution of no more than 65 dB LAeq, 1h is forecast, according to SR 10009: 2017 Acoustics, at the limit of the CNE site.

1.4.17 Methods for estimating the quantities and composition of all identified wastes and emissions and the uncertainty associated with these estimates

For the construction stage, the estimation of the quantities of waste was made based on the Conceptual Project of the CTRF.

The estimation of conventional pollutant emissions for the construction stage was done based on OM (Order) no. 3299/2012 for the approval of the methodology for conducting and reporting inventories on emissions of pollutants into the air and EMEP / EEA air pollutant emission inventory guidebook - Publications Office of the European Union, 2013.

For the operation stage, the estimation of the quantities of non-radioactive waste is based on the flow of materials necessary for the operation phase.

The estimation of conventional pollutant emissions was based on the estimated amount of fuel required for CTRF raw material transport activities, which was applied to the methodology for carrying out and reporting the inventories regarding the pollutant emissions mentioned for the construction stage.

This methodology has also been applied with the appropriate emission factors for estimation of quantities / volumes of emissions from burning fossil fuels from stationary sources – Stand-by Diesel generator groups.

The quantities of waste produced during the period of operation can be estimated with a high degree of confidence, in the case of flows related to the elements of technological installations (ion exchange resins, molecular sieves, catalysts and filling of isotope exchange columns), while in the case of secondary flows, such as materials from maintenance operations, maintenance, interventions in case of failure, it can only be estimated in order of size.

In estimating the quantities of waste and emissions identified, the data from the Conceptual Project were used, and methods that took into account the possible uncertainties.

Estimating the amount of radioactive waste, for the operation stage, was made based on the necessary elements of the technological installations (ion exchange resins, molecular sieves, catalysts and packing of isotope exchange columns) (according to table 1.4.3.2). For the decommissioning stage, the quantities and categories of materials to be classified as radioactive waste have been estimated taking into account the structures and installations which, during the planned operating period, are to come into contact with radioactive fluids (according to Table 1.4.4.2), according to the CTRF Conceptual Decommissioning Plan.

To estimate the quantities and composition of waste and effluents generated in the implementation stages of the CTRF project, the radioactive inventory of the installation was used as basic information, being calculated by the designer, based on the technical and functional characteristics of the installation, in conditions of operation while respecting the maximum activity concentration of 54 Ci / kg for tritium in heavy water supply. Information was used on the amount of waste and radioactive emissions from similar installations with experience in operation (WTRF and DTRF), in relation to the heavy water processing capacity specific to the installation. Conservatively, the projected quantities for CTRF operation have been estimated, with consistent application of good practice in the field.

Also, as regards the quantities and types of radioactive waste produced during the decommissioning stage, they shall be assessed within the decommissioning plan, which shall be updated every five years during the authorized period of operation of the installation. The decommissioning of the installation will be carried out under the conditions established by the corresponding authorizations, and the specific activities will start only after obtaining the necessary agreements / approvals, which include the environmental agreement (following its specific assessment procedure).

With regard to radioactive contamination of waste and effluents generated during the construction phase, it has been shown in the previous subchapters that the activities at this stage are not associated with the use of radioactive sources or materials. For the CTRF operation and decommissioning stages, the composition of radionuclides and the level of radioactive contamination of effluents and wastes are determined by the radionuclide composition of the heavy water fed to the CTRF. As the plant will be supplied by an ion exchange purification system [1], the radionuclide inventory in the plant, at the time of decommissioning, will consist preponderantly of tritium adsorbed on the surfaces of the plant's technological components [4].

2. DESCRIPTION OF FEASIBLE ALTERNATIVES

In accordance with the requirements of Law no. 292/2018 on the assessment of the impact of certain public and private projects on the environment and the Guide no. DEICP / 8885 of 10.09.2020 issued by the Ministry of Environment, Waters and Forests, this chapter presents the evaluation of the "Zero" alternative and the project alternatives (on-site and off-site), as well as the evaluation of the main options identified for the development of the CTRF project, namely:

- the location of the tritium removal installation in the perimeter of Cernavoda NPP; and
- heavy water tritium removal technology options.

CTRF was sized from the initial phases of the design to the current capacity in order to process 40 kg / h of tritiated heavy water. The installation works in stages, this capacity allows the treatment of tritiated heavy water from a unit, in a single stage. Once the stage is over, the treatment of the tritiated heavy water from the other unit starts. Thus, no alternative variants of CTRF capacity were studied.

The analysis of alternatives is performed in the following subchapters, based on the information from the Pre-Feasibility and Feasibility Studies, as well as other specialized studies, which were the basis for the analysis of the alternatives presented above. The potential environmental impact associated with the selected alternatives, as well as the prevention / mitigation measures planned

accordingly for each project alternative are identified in the tables with the impact forms presented for each analyzed alternative.

2.1 Identifying alternatives

2.1.1 "Zero" Alternative

The "Zero" or "no action" alternative is presented as a benchmark against which the other CTRF project alternatives are compared. According to this Zero alternative, the project would not be carried out in any form.

In case of continuing the operation of the U1 and U2 units within the Cernavoda NPP without the implementation of the CTRF project, practically no changes will be made in the current configuration of the units, the operation will continue according to the valid authorizations and according to the procedures in force [2].

With the "no action" alternative, there are possible difficulties arising in treating heavy tritiated water as radioactive waste at the Cernavoda NPP site [2].

Additionally, from a radiological point of view, the operation of the units without CTRF would lead to increases in environmental emissions, staff doses and production losses due to possible delays while the units are shut down and maintenance procedures are performed due to the high tritium content that requires appropriate radiological protection measures [2].

If Cernavoda NPP, with U1 in operation since 1996 and U2 since 2007, will not apply the process of Tritium removal to the tritiated heavy water, dose rates in the spaces of nuclear systems will increase and the values of tritium in heavy water in the circuits of nuclear systems will reach maximums of 80-90 Ci / kg, with effects on radiation fields and the dose received by staff and the local population [1].

Thus, in the absence of detritiation, the process fluid (heavy water) from the nuclear systems will have high levels of tritium, which will render it difficult for staff to implement preventive and predictive maintenance and will lead to the increase of the dose received by Cernavoda NPP staff.

Also, in the absence of detritiation, the emissions of tritium, respectively the concentration of tritium in solid radioactive waste, although they will remain well below the regulated limits, will be at higher values as a result of reaching the steady state in the reactor systems U1 and U2 [1].

2.1.2 Alternative 1: Detritiation at the CANDU nuclear power plant site (on-site)

The construction of the heavy water tritium removal installation at Cernavoda NPP aims to reduce the tritium inventory in the moderator circuits and the primary Heat Transport System from the two CANDU units of the plant. The need to make this investment is presented in both the Feasibility Study and the CTRF Presentation Memorandum.

From the point of view of the radiological impact on the environment, the implementation of CTRF is thought of as an investment to reduce the global impact on the environment as a result the operation of Cernavoda NPP. The CTRF project represents a commitment at the highest level of Cernavoda NPP to improve environmental performance, as it reduces the occupational exposure of workers to tritium, has a positive impact on ensuring staff's health and safety and reduces emissions of tritium in effluents, with additional positive impacts on the protection of the population and the environment.

From the experience of other CANDU power plants and from the observation of the trends regarding the level of tritium emissions from Cernavoda NPP in the environment, the evolution of tritium emissions correlates with the inventory of tritium in the systems of the plant containing heavy water, whose evolution is consistently increasing, reaching a plateau towards the end of the planned life, for each reactor. For example, Figure 2.1 shows the evolution of tritium activities emitted into the environment, in the form of liquid effluents, by Cernavoda NPP, throughout the operation period, since the commissioning of the first unit

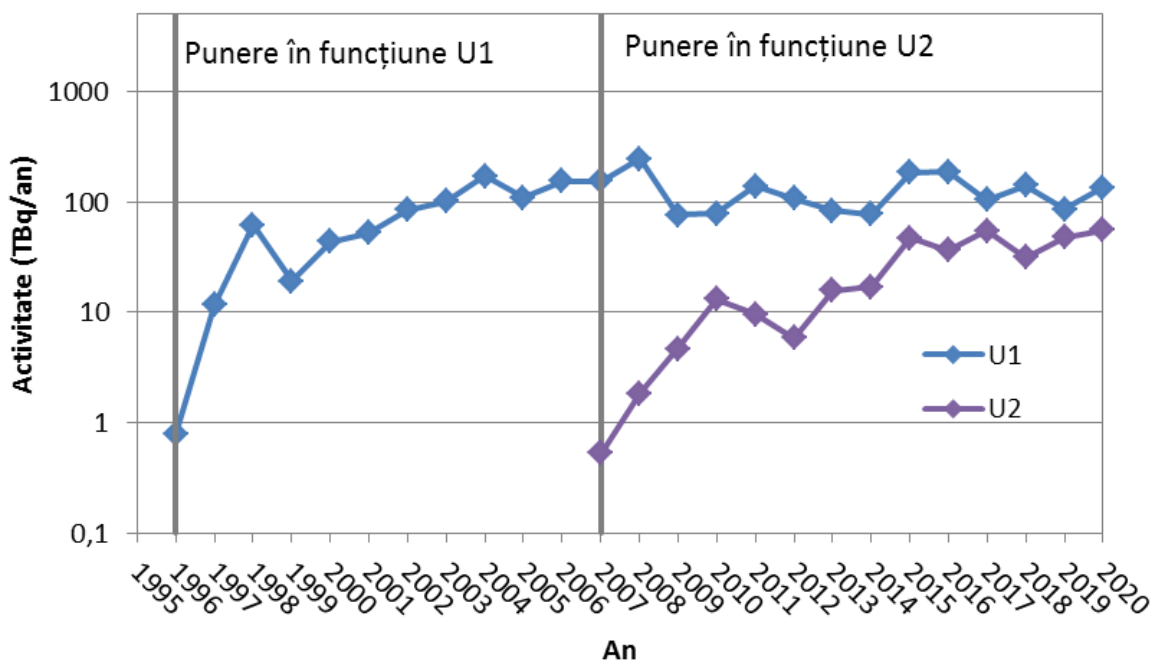

*(Activitate= activity / Punere in functiune= commissioning)

Figure 2.1 The evolution of tritium activities emitted in the environment, in the form of liquid effluents, by Cernavoda NPP, during the entire period of operation, from the commissioning of the first unit

Similarly, the evolution of tritium emissions in the form of gaseous effluents, presented graphically in Figure 2.2, shows the upward trend in the period after the commissioning of each unit, followed by their capping.

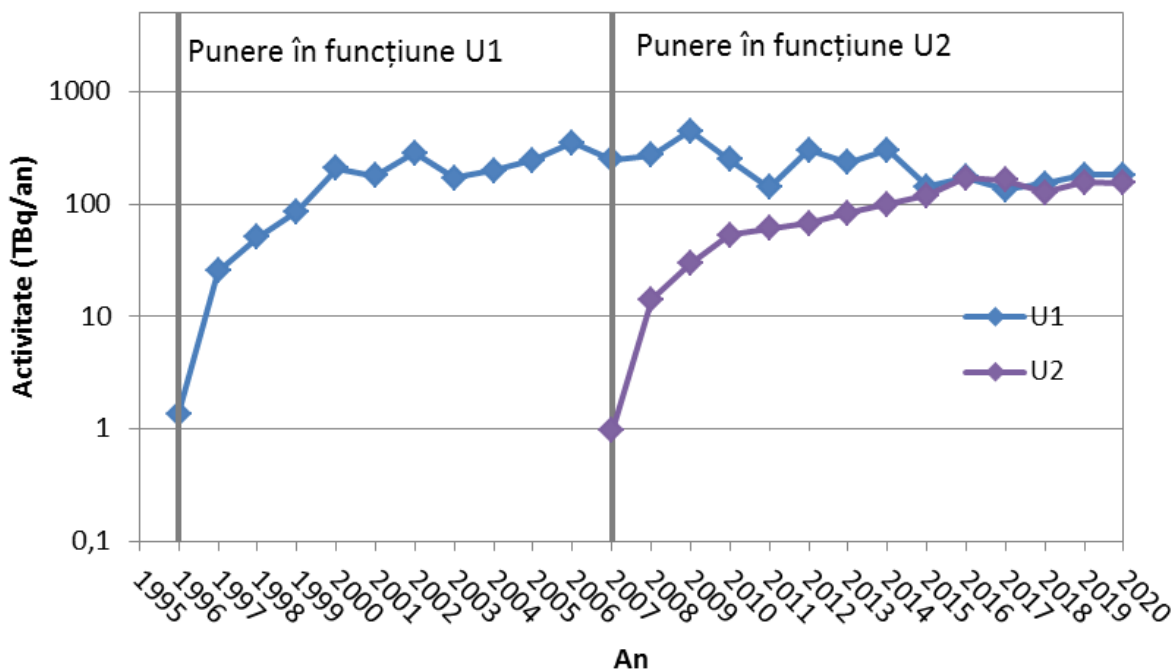

*(Activitate= activity / Punere in functiune= commissioning)

Figure 2.2 The evolution of tritium activities emitted in the environment, in the form of gaseous effluents, by the two CANDU units of Cernavoda NPP

If we analyze only the projections of emission levels in the environment, as a result of the operation of the two units of Cernavoda NPP, until the expiration of their planned life, it can be concluded that heavy water tritium removal is not absolutely necessary, the derived emission limits being much higher in relation to the annual, cumulative values of these emissions. However, other constraints related to the levels of tritium activity concentration in surface waters liquid effluents are discharged to, as well as considerations related to the exposure of Cernavoda NPP staff make the implementation of the CTRF project a necessity.

The experience of Cernavoda NPP and other CANDU plants shows that for the plant's staff, the increase of the received doses can maintain ALARA (As Low As Reasonable Achievable) below the administrative limit of 14 mSv / year, below the legal limit of 20 mSv / year, by implementing more detailed preparation of all works, limitation of leaks, access control in areas with radioactive contamination and extensive use of special protective equipment (plastic suits, respirators, tritium filter cartridges, etc.).

After the first year of operation of the CTRF installation, with the application of detritiation to reduce the tritium inventory in the moderator and primary heat transport systems of the two units of the NPP, a significant and continuous reduction of tritium levels in these systems is expected, as CTRF will extract tritium from heavy water and will convert it into a stabilized and isolated form - in line with the overall purpose of the project.

Thus, the implementation and operation of the CTRF installation will limit the contribution to the doses received by NPP staff through removing tritium from the reactor U1 and U2 systems, and maintaining a low-level steady-state concentration, respectively 10 Ci / kg in the moderator and below 2-2.5 Ci /kg in the primary heat transport system [1].

Against this alternative 1, 3 technological variants and 2 CTRF location variants were analyzed. The choice of the optimal location was based on the analysis of the advantages and disadvantages of several technologies and locations taken into consideration.

2.1.2.1 Technological options for the Cernavoda NPP tritium removal facility (CTRF)

From the analysis performed on the technologies available for the implementation of the Cernavoda NPP tritium removal installation, the following options were identified in the Pre-feasibility Study prepared for the Project [1]:

- **Solution 1** - CECE - CD (Combined Electrolysis and Catalytic Exchange - Cryogenic Distillation)

The CECE-CD solution is based on the transfer of tritium from water to the gaseous phase by a combined electrolysis process – isotopic catalysed exchange (thereby increasing the concentration of tritium in heavy water) followed by a final tritium concentration through cryogenic distillation and its safe storage (metal hydride).

- **Solution 2** - DE - CD (Direct Electrolysis - Cryogenic Distillation)

The DE-CD solution consists of tritium transfer to the gaseous phase by the electrolytic dissociation of the tritiated heavy water, followed by a final tritium concentration through cryogenic distillation and its safe storage (metal hydride).

- **Solution 3** - LPCE - CD (Liquid Phase Catalytic Exchange - Cryogenic Distillation)

The LPCE-CD solution is based on the tritium transfer from water to gas phase through a catalysed isotope exchange process followed by a final tritium concentration through cryogenic distillation and its safe storage (metal hydride).

Evaluation of technological alternatives

The first two technological solutions raise major implementation problems, as well as very high operating costs, which is why they have not been implemented anywhere in the world on an industrial scale [2].

The third solution has been implemented in Wolsong, South Korea and provides the necessary tritium removal services for the 4 CANDU 6 units there. An initial version of this solution, VPCE-

CD (Vapor Phase Catalytic Exchange), in which the transfer of tritium is done with heavy water in gaseous form (vapor), was implemented in Canada, in Darlington [2].

Based on criteria that took into account [1]:

- the minimum risk for the staff and the environment, associated with the tritium extraction technology;
- the corresponding size of the main components in relation to the location of the installation,
- the necessary process subsystems and the corresponding size in terms of complexity, operability and maintenance;
- Minimal D₂O and tritium inventories and storage of tritium, operation and maintenance specific safety issues;
- Utilities and optimal operating costs;
- authorization requirements for the technological solution;
- the estimated cost of the investment;
- Potential contractors for services and materials availability in Romania and operational requirements.

The decision was made to implement the LPCE - CD (Solution 3) based technology developed at ICSI Rm. Vâlcea within the Pilot Installation and for which there is operational experience (OPEX) at the Wolsong tritium removal facility (WTRF) in Korea.

The implementation of CTRF allows a significant reduction of the total inventory of tritium (radioactive isotope of hydrogen) from the CANDU type Nuclear Power Plant, with a positive impact for:

- reducing the level of risks of generating radioactive effluents and tritium emissions in the environment, risks associated with the transport of a large amount of heavy water with high concentration of tritium through the nuclear systems of the plant;
- minimizing the tritium concentrations in radioactive waste generated within the nuclear systems that use heavy water at Cernavoda NPP - Unit 1 and Unit 2.

The operation of the CTRF will reduce the tritium concentration from 80-90 Ci / kg to about 10 Ci / kg for the *Moderator System* and from approx. 2-2.5 Ci / kg, to under 2 Ci / kg, for the Primary Heat Transport System. This translates into a gradual reduction, to almost an order of magnitude lower, of the tritium inventory in the plant's facilities and, implicitly, a reduction in the tritium emissions from the liquid and gaseous effluents produced on site.

Given that a similar tritium removal project implemented at the Wolsong - South Korea nuclear power plant has been reported to reduce the total atmospheric tritium emissions of the units after the WTRF tritium removal facility came into operation, as well as the fact that potentially contaminated wastewater from the technological area of the CTRF will not be discharged directly into the environment, it can be appreciated that the normal operation of the CTRF, integrated into the normal operation of Units 1 and 2 of Cernavoda NPP, provides a measure to improve the protection of aquatic and terrestrial ecosystems as a result of the operation of the Cernavoda NPP platform. Additionally, based on the operational experience of other similar installations, it is estimated that by applying the tritium removal of heavy water from the active systems of the plant, a reduction in the exposure of personnel and the population will be obtained in the area of influence of the plant. Thus, from the first year of operation, a reduction of up to 20% in tritium emissions from the NPP site is expected, followed by a corresponding decrease in the radiological impact on the environment and the population.

2.1.2.2 Layout / areas options on the site of the nuclear power plant

Tritium removal on the site of the CANDU nuclear power plant (on-site) has two location variants within the Cernavoda NPP.

In order to optimize the location, two location variants for locating the CTRF on the Cernavoda NPP platform were successively considered, as follows:

- **Location Variant 1:** Location in the area between units U1 and U2 - the area between the physical protection fence and the road in the vicinity of the D₂O reconcentration tower and

the high-pressure level building for the cooling of the active area related to Unit 1 (Annex 3);

- **Location Variant 2:** Location on the land located at approx. 200 m East of the U1 reactor - bounded by the slope to the Saligny hill and the main road inside the NPP which allows access from the PCA1 gate to the Water Treatment Plant (STA), the Thermal Start-up Plant (CTP) and leads to the DIDS. On one side it is partially bordered by a concrete wall which has the role of explosion protection (Annex 4).

In the first phase of the project (between 2009-2010), for mainly economic reasons, namely the need for a maximum proximity of U1 and U2, to shorten the heavy water routes between CTRF and Units, the first option analyzed for the location of CTRF was its location between U1 and U2, respectively at 11 m from U1 and at 36 m from U2. The aim was also to minimize the potential impact on the environment and the population that could be caused by the accidental rupture of heavy water pipes and the spread of radioactive heavy water in the environment.

This location variant was re-analyzed in 2011 based on safety criteria and the hypothesis of an explosion of the hydrogen inventory of the tritium removal facility was analyzed. Early analysis showed that the key factor in managing CTRF's nuclear safety is not tritium but the potential explosion of hydrogen.

Thus, numerous simulations were performed in the CTRF Evaluation of Design Options for Hydrogen Safety (KI CTRF-00084-0) [11]. The study showed that a possible explosion of the hydrogen inventory produced at the location variant 1 CTRF site would lead to a major impact on U1 and U2, resulting in potentially significant radioactive emissions.

The study CTRF Evaluation of Design Options for Hydrogen Safety (KI CTRF-00084-0) analyzed many technical options before deciding to move the CTRF, amongst these options studied were technological, design and construction alternatives for the building.

Thus, through the project, measures were taken for minimizing potential hydrogen releases (double / vacuum enclosures, installation of passive recombiners, installation of double isolation valves, passive ventilation system in case of emergency, earthquake classification, etc.) by simulating conditions that may lead to explosions / fire. All these measures are incorporated into the current project.

The design of the CTRF building as an isolation structure was also simulated. This was considered based on the decision to design the CTRF building as a large concrete structure with the capacity to insulate the CTRF installation. The analysis concluded that this would make the installation of equipment and the operation of the installation very difficult.

These considerations regarding location variations led to the conclusion that the only acceptable risk-reducing option is to move the CTRF location to more than 100 m from U1 and U2.

The simulations performed for the assessment of radiological risks in accident situations at CTRF showed that by placing the CTRF at a distance of more than 100 m from the two nuclear power units of NPP, the maximum effective dose for the personnel of these units decreases by at least one order of magnitude compared to that which would be achieved in the conditions of the location in their vicinity (less than 50 m, as set out in location variant 1) [99]. As for Cernavoda NPP, the operating activities involve the presence of a large number of people in the buildings of the two units, the collective dose in the event of an accident at CTRF is significantly reduced in the case of the location variant 2.

Thus, the current location (location variant 2) of the CTRF installation was selected in 2011, following the evaluation carried out by the "Technical study for assessing the location of the Cernavoda NPP tritium removal facility on the site of the former hydrogen production station and preliminary analysis on the danger of a potential explosion on neighborhoods" [16].

This study made a qualitative assessment of the current site in terms of potential hazards caused by site characteristics, external events due to human activities in the area of influence of the plant,

natural phenomena, potential effects of the plant on the installation and the effects of CTRF on the Cernavoda NPP.

The potential radiological impact in the normal state of operation and accident conditions on the plant's operating personnel and on the population were considered in the light of the measures provided in the plant's emergency plans. Detailed analyses were also performed on the effects of a potential hydrogen inventory explosion of the CTRF installation on the Cernavoda NPP. Among other things, the analysis showed that the concrete explosion protection wall aims to mitigate the shock wave caused by a potential explosion by reducing the impact on the CTRF neighborhoods.

The environmental assessment of the two variants shows that there are no significant differences between the two location variants, in terms of potential impact on the environment, according to the brief presentation in Table 2.1.2.1.

Table 2.1.2.1. The impact of the location variants for the tritium removal installation in the premises of Cernavoda NPP, on the environmental factors possible to be affected

Environmental issues	Location Variants		Comments	
	The technical solution	Variant 1- Tritium removal on the site of the CANDU nuclear power plant (on-site), location between reactors U1 and U2		Variant 2 - Tritium removal on the site of the CANDU nuclear power plant (on-site), current project location
Water quality	<p>The same technical solution has been designed for both locations:</p> <p>In the operation phase, the installation is connected to the water supply and sewerage system of Cernavoda NPP.</p> <p>On the routes of heavy water and radioactive liquid waste between CTRF and U1 / U2, safety measures are provided against accidental spills (concrete platforms, pipe-in-pipe system, leak detection sensor, etc.).</p>	<p>The CTRF water supply and sewerage systems are connected to the related subsystems between U1 and U2 of NPP.</p> <p>The routes of heavy water and radioactive liquid waste between CTRF and U1 / U2 would have been located in a pit, and would be shorter</p>	<p>The water supply and sewerage systems of CTRF are connected to the subsystems related to U1 coming from the STA (Water Treatment Plant).</p> <p>The routes of heavy water and radioactive liquid waste between CTRF and U1 / U2 will be mainly aerial on existing / new and significantly longer trestle / supports.</p>	<p>The connections of the water supply and sewerage system of CTRF to those of NPP are equivalent, without significant differences with regard to environment.</p> <p>The higher probability of breaking the lines of heavy water and radioactive liquid waste from CTRF to U1 / U2, in Alternative 2, due to longer routes, is insignificant (according to accident studies) given the DBE qualification of the routes / supports.</p>
Air quality	According to the analyzed studies, the technical solution is the	During the construction phase, the works being very close to	In the construction phase the works being at approx. 100 m from U1, the	In the construction phase the differences are relatively minor with

	<p>same for both locations.</p> <p>Some forms of impact on air quality may occur during the construction phase, but measures will be taken to ensure that emissions are within legal limits. Short-term emissions from construction activities (dust, gas emissions) are expected during the testing periods of diesel generators, but these will be maintained within the legal limits of protection of human health and the environment.</p> <p>During the operation phase, emissions from the CTRF's stack are generated in the medium and long term, but these will be kept within the limits of employee safety, human health and environment safety.</p>	<p>U1 / U2, the interferences with the exploitation activity will be more pronounced (traffic, visual impact, noise, emissions of polluting gases from equipment, etc.).</p> <p>During the operation phase, the stack being positioned between the tall buildings of U1 and U2 may have needed to be higher (which would have attracted higher costs) for better dispersion in the environment. Additional leakage analysis related to possible interference or accumulation with U1 / U2 emissions would have been required.</p>	<p>interferences with the exploitation activity are significantly lower.</p> <p>The analysis carried out so far indicates that the current solution with a 50 m ventilation stack is acceptable.</p>	<p>regard to the environment and in any case, they are to the advantage of Option 2.</p> <p>For the operation phase, the differences between the Alternatives are minor, Alternative 2 having the advantage of a better effluent dispersion, in the conditions of maintaining the height of the discharge stack, according to the current project.</p>
Soil / subsoil	<p>The same technical solution has been designed for both locations:</p> <p>A potentially negative impact may occur during the construction phase due to the excavation activities required for the construction of the</p>	<p>During the construction phase, excavations will be carried out for the foundation and basements of the CTRF building, as well as on the route of the underground pipes used for the transport of heavy water, liquid radioactive waste</p>	<p>During the construction phase, excavations will be carried out for the foundation and basements of the CTRF building, as well as on the route of the buried pipes used to connect to utilities.</p> <p>The pipelines used to transport heavy water and liquid</p>	<p>CTRF connections to NPP utilities are equivalent, with no significant differences. Also, the footprint of the CTRF building and the depth of the foundations are the same in both variants.</p> <p>Alternative 2 has the advantage that the soil is affected</p>

	<p>CTRF building and adjacent facilities (trestle pillars, adjacent concrete platforms, utility connections, etc.).</p> <p>During the operation phase, ensuring maintenance and intervention in an accident situation.</p>	<p>and connection to utilities.</p> <p>During the construction period, it would have been necessary to relocate the nitrogen tank and the related concrete platforms.</p> <p>Interventions require uncovering the ground to gain access to pipelines with a potential impact on the ground.</p> <p>In the event of an accident, the potential impact on the ground is also represented by potential additional excavations needed to remove or restore the heavy traffic road between the units.</p>	<p>radioactive waste will be suspended, the surface of the ground being affected by the footprint of the base of the new trestle support pillars, which will be connected to the existing trestle.</p> <p>The intervention will be made on the above-ground pipes without potential impact on the soil.</p>	<p>on a smaller surface (the footprint of the base of the pillars) to make the connections of the pipes for transporting heavy water and liquid radioactive waste.</p> <p>Also, in the period of operation in the case of alternative 2, there will be no potential impact on the soil.</p>
--	--	--	---	---

Following the evaluation of the two location variants, it was observed that the other environmental factors were not affected.

It was decided to adopt location variant 2 for implementing the project "Construction works for the heavy water Tritium removal plant - Cernavoda NPP". The tritium removal facility location at Cernavoda NPP is therefore proposed for the land located 200 m east of the U1 reactor, this location results in the reduction of the danger to nuclear safety systems, equipment and components of nuclear units U1 and U2 by increasing the distance and layout in relation to them.

In conclusion, the current on-site, location and technology alternative has the following advantages and disadvantages:

Benefits:

- Uses existing facilities for U1 and U2 related to utilities (electricity, heat, water supply, sewerage, rainwater, water supply system for extinguishing fire), physical protection system, short distance connection to STA for technological cooling water supply;
- Uses facilities for draining potentially radioactively contaminated water into existing systems;
- Compared to the off-site alternative, the on-site alternative ensures the continuous treatment of tritiated heavy water from the plant systems and avoids its storage;

- CTRF will contribute to the reduction of the quantity of radioactive waste (tritiated heavy water), thus reducing the quantities of radioactive waste resulting from the operation and, subsequently, the decommissioning of U1 and U2;
- Reducing emissions to the environment by reducing the amount of tritium in heavy water used by U1 and U2.

Radiation protection is provided by the application of a tritium leakage management system, integrated with the on-site emission management system. The facility and arrangement measures in the Project ensure the isolation of the danger of leaks and the control of the actual contamination in case of leaks and include the following [1, 11]:

- A secondary coating for equipment such as:
 - Double walls for tritiated heavy water transfer pipes from Unit 1 and Unit 2 to the CTRF building;
 - Use of „glove-box” spaces to control tritium leaks;
 - „Cold box” secondary coating of cryogenic distillation columns;
 - Atmospheric detritiation system (ADS) that recovers tritiated heavy water vapor from heavy water leaks;
 - Installation of deep drain trays, which are positioned to collect and retain tritium leaks;
 - Contamination control by keeping tritium concentrations in the air below 0.4 MBq / m³ in the accessible areas;
 - A radiological zoning of the CTRF building: the spaces inside and on the CTRF site will be zoned according to the specific criteria established by CNCAN (Art. 93-99 of the Rules on basic radiological safety requirements, approved by Order of the Minister of Health, of the Minister of National Education and of the President of National Commission for Nuclear Activities Control No. 752 / 3.978 / 136/2018) and Cernavoda NPP procedures (RD-01364-RP009);
 - Equipment for staff radiological protection.
- The related personnel will be monitored dosimetrically and will benefit from appropriate protection and / or radiation protection equipment, as appropriate [5].
 - The installation is directly connected to the U1 and U2 systems, as there are no transport costs and environmental risks associated with it.
 - The risks of accidents are reduced, considering the qualified staff of Cernavoda NPP and its emergency procedures.

Disadvantages:

- The disadvantage of adopting the on-site location variant lies in the need to adopt special measures for the organization of CTRF execution works in the vicinity of the U1 / U2 nuclear units, in operation, due to the special regime of personnel and equipment access to the site.

2.1.3 Alternative 2: Tritium removal in other off-site facilities

This option involves extracting a large amount (hundreds of tons) of tritiated heavy water from the reactor systems (moderator and PHT) and transporting it to an existing tritium removal unit (Korea or Canada). The extracted heavy water will be replaced, in the first stage, with virgin heavy water, and in the following stages, it will be replaced with detritiated heavy water at other detritiation installations, such as those existing in Korea or Canada. These operations of handling and transporting heavy water with high tritium contamination outside the NPP site are associated with significant risks of environmental pollution and exposure of the population, in the event of an event with massive release of radioactive material.

Benefits:

- avoiding the contribution that the individual doses that would be received by the operators of the on-site tritium removal unit would bring to the collective dose of the plant;

- avoiding the production of new quantities of radioactive waste in addition to those already existing on site.

Disadvantages:

Due to the fact that there are few detritiation installations currently worldwide, it is expected that the price of this service will be very high, and in the event that this activity could be carried out, a number of other difficulties may arise, such as:

- potentially significant negative environmental impact due to the movement of large amounts of radioactive material outside the NPP site (hundreds of tons of tritiated heavy water with tritium activity that can exceed 54 Ci / kg). This negative impact will be manifested both on the environment and on the staff and the population, as a result of possible transport events.
- Replacing the large amount of tritiated heavy water removed for treatment, with an equivalent amount of virgin heavy water, consequently, a considerable increase in the demand for heavy water per unit, and associated costs.
- the occurrence of problems related to the need to store large quantities of heavy tritiated heavy water in order to prepare for transport.

In conclusion, alternative 2 could have a potentially significant negative environmental impact, as shown above, primarily affecting the population and the environment.

The potential impact on the compared environment of the 3 alternatives - zero, on-site and off-site is summarized in Table 2.1.3.1.

Table 2.1.3.1 The potential impact on the comparative environment of the 3 alternatives - zero, on-site and off-site

Environmental issues	Alternatives		
	Alternative 0 - No Action	Alternative 1 - Tritium removal at Cernavodă nuclear power plant site (on-site)	Alternative 2 - Tritium removal in other off-site installations.
Water quality	Potential impact due to liquid radioactive emissions.	From a radiological point of view, the installation has a positive impact by reducing the tritium emissions resulting from the operation of the plant.	From a radiological point of view, the installation has a positive impact for the Cernavoda NPP site, due to the reduction of tritium emissions. The off-site alternative can have a potentially negative impact on water quality due to possible accidental spills during transport.
Air quality	Potential impact due to gaseous radioactive emissions.	Positive impact by reducing tritium emissions from plant operation.	From a radiological point of view, the installation has a positive impact for the Cernavoda NPP site, due to the reduction of tritium emissions. Potential negative impact caused by possible accidental spillage (heavy tritiated water) during transport. The off-site alternative can have a potential negative impact on air quality through emissions from fuel

			consumption during transportation operations.
Soil / subsoil	Potential impact caused by tritium inventory.	No significant direct impact during CTRF operation, the installation being located on the NPP site. Radiologically positive impact by reducing tritium inventory.	Potential negative impact caused by possible accidental spillage (heavy tritiated water) during transport. Potential negative impact of the off-site alternative due to accidental spillage during loading / unloading, transport and storage of radioactive waste.
Biodiversity	Potential impact of liquid and gaseous radioactive emissions.	Positive impact by reducing the dose to aquatic and terrestrial organisms.	Potential negative impact caused by possible accidental spillage (heavy tritiated water) during transport. Potential negative impact of the off-site alternative due to the consequences of accidental spillage during loading / unloading, transport and storage of radioactive waste.
Landscape	The current state of the landscape does not change.	Insignificant impact, the CTRF building and the ventilation stack will not determine a visual impact, since they are included in the industrial area of Cernavoda NPP.	The current state of the landscape does not change.
Noise	The current noise level does not change.	Insignificant impact, due to the implementation of protection measures in the construction phase. During the operation phase, the project introduces new sources of noise (inside the CTRF building), but these will not exceed the legal limit for the industrial area and thus there will be no impact associated with noise sources.	The current noise level does not change.
The population	Loss of local job opportunities and loss of support for the development of modern facilities.	Positive radiological impact, by carrying out the CTRF installation, the doses collected by the population will be reduced as a consequence of the reduction of tritium emissions from the site. Creating jobs for the local population.	Potential negative impact associated with the risk of tritium being released into the environment as a result of a transport accident. The off-site alternative leads to the loss of local job opportunities, loss of support for the development of modern facilities, high costs of transport, treatment and conservation of heavy tritiated water.

Health of NPP employees	The current state of exposure of NPP personnel does not change.	Positive radiological impact. Tritium removal from heavy water will lead to a reduction in individual effective doses for operating personnel.	Positive impact by reducing effective doses. Tritium removal from heavy water will lead to a reduction in individual effective doses for operating personnel.
Cultural heritage	It does not affect the cultural heritage, the activity of the NPP being carried out on an industrial platform.	It does not affect the cultural heritage, the activity of the NPP being carried out on an industrial platform.	It does not affect the cultural heritage, the activities taking place on an industrial platform.

From the point of view of the radiological impact on the environment, the evaluation of the alternatives must be made by reference to alternative 0 (failure to carry out the project). From this point of view, as the CTRF operation is complementary to the authorized practice for the Cernavoda NPP platform (electricity generation by nuclear means), the implementation of any of alternatives 1 and 2 will have a positive impact on the environment, by reducing the concentration levels of tritium in the moderator system and in the primary heat transport system from the two NPP units. The immediate consequence will be a reduction in overall tritium emissions from the site and thus a reduction in the activity concentrations of this radionuclide in the affected environmental factors. The assessment of the radiological impact on the environment associated exclusively with the operation of the CTRF showed that it is negligible, in relation to the impact due to the operation of the plant, the planned radioactive emissions of the CTRF (tritium) NPP, while the effect of the application of the tritium removal process will lead, from the first year, to a reduction of more than 10% of the global tritium emissions of the plant. However, Alternative 2 involves high implementation costs, as off-site tritium removal facilities that can provide these services are located at great distances from the NPP (Korea, Canada). Moreover, international shipments of radioactive materials are difficult to authorize (high costs, long time), and during transport to off-site installations, accidental leaks of heavy tritiated water may occur, causing significant deterioration in the quality of the environment.

No residual impact was identified for the three analyzed alternatives, zero, on-site and off-site alternative. However, it can be seen that in the case of the zero alternative, there are long-term risks associated with the accumulation of tritium in the systems (moderator and PHT) of the plant.

Thus, based on all these analyses, the CTRF alternative located in the perimeter of the Cernavoda NPP, current location and technology, was selected. The potential impact of this alternative is discussed in detail in the following chapters of this report.

3. DESCRIPTION OF THE RELEVANT ASPECTS OF THE CURRENT STATE OF THE ENVIRONMENT

Cernavoda Nuclear Power Plant is located in Constanța County approx. 2 km southeast of the border of Cernavoda and approx. 1.5 km northeast of the first lock of the Danube-Black Sea navigable canal, on the land of the limestone quarry "Ilie Barza". The plant is located in the area of the platform resulting from the excavations from the quarry, on a filling with general size of + 16.00 md MB.

The site is bordered in the north-northeast area by Valea Cișmelei and in the southwest area by DJ 223 and the Saligny - Cernavoda - city railway line. To the southwest, the site is bordered by DN 22C and the secondary access railway line in the industrial and port area of Cernavoda.

The land inside the Cernavoda NPP, on which the CTRF project will be built, is located in the fixed front of the plant and is limited by the slope towards Saligny Hill and the main road inside the NPP - which allows access from the PCA1 gate to the Water Treatment Plant (STA), and the Thermal Start-up Plant (CTP), and leads to DIDSR. On one side it is partially bordered by a concrete wall which has an anti-explosion role [1].

Currently, the project site is represented by a small plot of land, which is covered with mowed grass and limited by the concrete platforms of Cernavoda NPP. The site is surrounded by the components and facilities of the Cernavoda NPP (Figure 3.1.1).



Figure 3.1.1 CTRF project location

Depending on the use of land in the location area at macro level, the dominant areas are mostly arable land arranged for irrigation, but large areas also have pastures, vineyards and some orchards [15].

The arable lands are located in the NE, ENE, E and SE part of the territory. The viticultural areas are spread around the localities of Cernavoda, Cochirleni, Rasova, Aliman, Medgidia, Mircea-Voda, Tortomanu. Most of the orchard areas are east of Cernavoda, in the Mircea-Voda and Medgidia areas. Cereals (corn, wheat), oil plants (sunflower) and fodder plants occupy most of the arable land [15].

In the area with a radius of 30 km around the plant, the Danube River along with the Borcea arm, lakes, ponds, pools ensure optimal conditions for industrial and sport fishing [15].

3.1 The water environment factor

3.1.1 Surface waters

In the area of the site, surface waters include 4 watercourses:

- Danube river;
- Danube-Black Sea Canal;
- Valea Cișmelei; and
- Valea Viteilor.

From the positioning point of view, the Cernavoda NPP site is located approx. 4 km southeast of the Danube River and approx. 1.3 km northwest of lock no. 1 of the Danube-Black Sea navigable canal. To the northeast, the site is bordered by Valea Cișmelei, and to the southeast by the derivation canal of the Danube- Black Sea navigable canal [15].

Danube river is a branched riverbed from km 374.8 to km 240. From the main riverbed the Borcea branch separates to the left at 370.8 km, and Bala branch at 345 km.

In the downstream part of the Danube branch between the ramification of the Bala branch at 345 km and the confluence with the Borcea branch at 240 km, the derivation of the Danube-Black Sea canal is located at 299 km on the right bank on the route of which, at approx. 3 km from the Danube branch, the cooling water adduction canal at Cernavoda NPP branches off on the left. The meadow sector unfolds like a circular arch, on a length of 100 km, with a width of 5 - 6 km in the southern part which increases up to 15 km between Fetești and Cernavoda, narrowing again towards Vadu Oii (Figure 3.1.1.1).

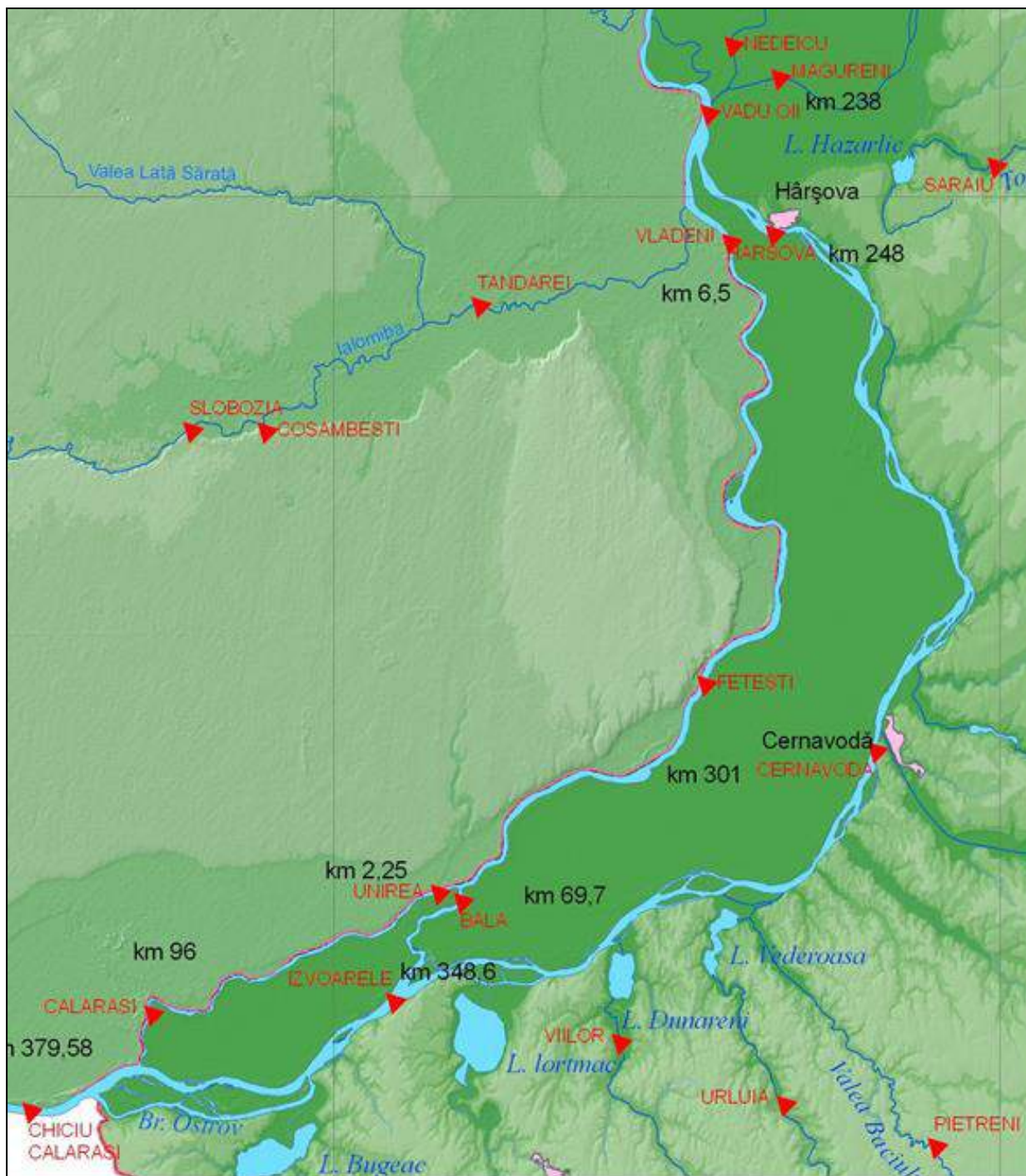

Figure 3.1.1.1 The Danube River in the area of the Cernavoda NPP site

Source: Final Safety Analysis Report for CNCAN, 2020

Danube Black Sea Canal has a length of 64432 + 29000 m and is a river navigation artery that crosses Dobrogea between Cernavoda and the port of Constanța - Agigea, respectively Midia

Năvodari. It consists of three ponds, separated by the locks from Cernavoda, Agigea, Midia Navodari, namely:

- Pond I with a length of about 4.1 km, between the Danube and the Cernavoda lock (upstream). In the area of the Cernavoda lock, the bypass canal which connects Pond 1 and Pond 2 by bypassing around the lock;
- Pond II with a length of about 58 + 29 km, between the Cernavoda lock (downstream) and the Agigea / Midia Navodări lock (upstream);
- Pond III with a length of about 1.5 km, between the Agigea lock (downstream) and Midia Năvodari and the Black Sea.

The connection point of Poarta Albă - Midia Navodări canal is located at kilometer 35 + 332 km (29 + 100).

Pond I of the Danube-Black Sea Canal, 4.1 km long, is positioned between the Danube river and the Cernavoda hydrotechnical node. The cross section is trapezoidal with slope inclinations between 1: 2 and 1: 4.5. The bottom of the canal is located at elevation -1.50 mrMB. The width of the canal at the bottom is variable, with values between 70 m and 160 m.

At 2 + 864 km (61 + 568) begins the connection area with the bypass canal that goes around the Cernavoda hydrotechnical node, called the bypass canal. In the Cernavoda NPP area, the 340 m long adduction canal starts from the bypass canal with a trapezoidal section with a bottom width of at least 35 m and a 1: 5 slope inclination, located between the CF and DN 22 bridges and the pumping station of the Nuclear Power Plant.

Pond II of CDMN has a length of about 58 km located between the locks of Cernavoda and Agigea. Throughout the bypass, the bottom of the canal is located at +0.50 mrMB. The cross section is trapezoidal with slope inclinations between 1: 0.2 and 1: 4.5. The width of the canal at the bottom is variable, with values between 70 m and 141 m.

Pond III of the CDMN is 1.5 km long and connects the Agigea lock to the Black Sea. The bottom of the Pond is located at - 7.50 mdMB. The cross section is trapezoidal with a bottom width of 150 m [15].

The Poarta Albă-Midia Năvodari canal connects with the second Pond of the CDMN at 35 + 332 km (29 + 100). It has a length of approx. 26 km and consists of two Ponds:

- Pond I with a length of 15230 m is between CDMN and Ovidiu lock. The bottom of the canal is located at 1.50 mdMB. The cross section is trapezoidal with a width between 35 and 57 meters at the bottom and a slope of 1: 4 and 1: 0.2. The normal operating level is at 7.50 mdMB;
- Pond II with a length of 9.940 meters starts from the Ovidiu lock, passes by the Siutghiol and Tașaul lakes and ends at the Midia Năvodari lock. The bottom of the channel is located at a height of -2,00 mdMB. The cross section is trapezoidal with a width between 35 and 57 meters at the bottom and a slope of 1: 0.2 and 1: 4. The normal operating level is 4.00 mdMB.

In the area of the Cernavoda lock a bypass canal (bypass of the lock) is built, which has a dam and a pumping station at the downstream end, a canal that is part of the Pond I of the CDMN.

The waterflows necessary for the cold water supply of the NPP, irrigations, drinking water supply of the city of Constanța and locks (navigation) are transported through Pond I and through the bypass canal.

The maximum flow of water transported on the canal for navigation, irrigation and water supply is 225 m³ / s, and the maximum flow of water supply of Cernavoda NPP is 53.8 m³ / s per unit operating at rated power.

The normal level of 7.50 mdMB in Pond II is maintained by the dam and the pumping station on the derivation canal by closing / opening the dam. Alternatively, the pond can be maintained by pumping the excess through the Agigea micro hydropower plant [15] as the water levels in the Danube are higher or lower than the quota of 7.50 mdMB.

Valea Cişmelei borders the Cernavoda NPP location on the northeast and west sides. The characteristic flows on this valley with torrential regime can be up to $458 \text{ m}^3 / \text{s}$.

The flow of $458 \text{ m}^3 / \text{s}$ from the entire reception basin with the assurance of 0.01% is evacuated in Pond I of the navigable canal, upstream of the power plant (in the area separating the derivation canal from the navigable canal, on the current route of Valea Cismelei).

The solution for draining water from Valea Cişmelei consists in the execution of an open canal with a trapezoidal section based on a width of 15.00 m, embankments of 1: 2, a depth of 4.00 m and a slope of the foundation plate of 0.002.

The protection of the embankments of the canal is made with dry wall of raw stone 30 cm thick, on a height of 2.5 m corresponding to the water level to ensure 1.0%. Above this level it is planned to cover the slopes with grass.

On the upstream area of Valea Cişmelei on approx. 800 m (the area corresponding to the U-row of the five units) the natural drainage section was maintained and only a leveling of the valley floor with a slope of 0.002 was performed. The protection dam of the power plant at an elevation of 18.00 mdMB has a slope of 1: 3, a top width of 4.00 and the slope towards Valea Cişmelei is protected by a raw stone wall.

At the bypass canal output, an energy dissipator was provided consisting of a rapid canal protected by boulders and stabilopoies laid on the fascine mattresses on both the slopes and the foundation plate [15].

Also, in Valea Cişmelei, in case of damages that may occur during the hot water evacuation works in the Danube, the evacuation of a flow of approx. $54 \text{ m}^3 / \text{s}$ was provided by means of a spillway [15].

Valea Viteilor is located outside the NPP area and is not directly influenced by it. The maximum water flows of this valley in torrential regime are the following:

Q _{sig.} 10%	$19.7 \text{ m}^3 / \text{s}$;
Q _{sig.} 1%	$47.1 \text{ m}^3 / \text{s}$;
Q _{sig.} 0.1%	$88.9 \text{ m}^3 / \text{s}$.

The water collected and transported on Valea Viteilor is discharged in Pond I of the CDMN.

The adduction canal has the role of capturing the water flow required for condenser cooling, raw technical water, backup cooling water, fire-extinguishing water and emergency cooling water from the CDMN derivation canal and transporting it to the sieve chamber and the pumping station.

The adduction canal was sized in such a way that the maximum cooling water flow of $269 \text{ m}^3 / \text{s}$, required for 4 groups of the plant, can pass through at low levels in the Danube corresponding to flow rates with 97% assurance, with a speed of 1.12 m / s, speed that does not lead to erosion of the bottom of the channel. The hydraulic slope is 0.00054.

The 370 m long adduction canal has a trapezoidal section with a slope of 1: 4.5 with a width of 34 m at the base and a bottom elevation of -1.00 mdMB. The crown of the contour dams is at 13.50 mdMB for flood protection of low areas, at flows with 1% assurance, as well as the derivation canal.

The distribution basin has the role to connect the adduction canal to the Sieve Chamber and to ensure uniform access of water to the pumping station. The distribution basin is bordered by slopes identical to those of the adduction canal, and its bottom is at -1.00 mdMB.

The emergency water pumping station (EWS) is also supplied from the distribution basin. The height of the EWS water intake is 0.50 mrMB, the height in the axis of the adduction pipe [15].

3.1.2 Groundwater

Studies performed for Cernavoda NPP state that the site is located in the hydrogeological basin of South Dobrogea. The South Dobrogea Bason consists of Jurassic limestone over which the Valanginian layer composed of marly clays is deposited It is practically impermeable and has an average thickness of 130 m. In this aquifer the water flow is under pressure.

The Barremian limestones on which the plant is founded are deposited on the Valanginian clays and form an aquifer in which the flow is free.

Due to the large thickness of impermeable clays, as well as to the absence of structural faults, drainage between the Jurassic aquifer and the water confined to the Barremian is unlikely. Under these conditions, the process of groundwater flow in the Barremian limestones is independent, they form a separate aquifer.

Aquifer alimentation is based on 2 main alimentation supplies.

The first source is due to the precipitations that infiltrate the limestone, in the hill areas and that generate a radial flow to the southeast and northwest, the groundwater being drained by Carasu Valley, respectively by Țibrinului Valley. The water supply in the hill area is increased by the losses from the irrigation canals.

The second source is the Danube, whose levels have an average annual variation of approx. 6 m (11.50 m maximum level, 5.50 m minimum level).

According to the study elaborated by ICH, the groundwater level in the area of the Cernavoda NPP enclosure is influenced by the infiltrations from: precipitations, irrigation systems on the plateau, the Danube river, the navigable canal Danube - Black Sea and Valea Cișmelei. Under these conditions, the groundwater flow in the site is non-stationary, the main levels and directions of flow undergoing important changes during a year, depending on the water level in the Danube.

The variations of the forecasted groundwater levels in the natural hydrological regime of the Danube, for the area of the Cernavoda NPP enclosure, are the following [15]:

- normal	8.50 mdMB
- maximum, with a frequency of 1/50 years	11.50 mdMB
- maximum, with a frequency of 1/100 years	12.00 mdMB

Leakage and drainage

Leakage and drainage are presented in detail in Chapter 1, subchapter 1.3.4. of this report.

The management of radioactive effluents is presented in detail in Chapter 1, Subchapter 1.4.8 of this report.

The discharge of non-radioactive liquid effluents is described in detail in subchapter 3.1.4 of this report.

All these drainages are collected in the drainage systems of the Cernavoda NPP.

3.1.3 Water quality and use

Through its own Chemical Laboratory and through specialized third-party laboratories, water quality is subject to verification according to the Physico-Chemical Monitoring Program of non-radioactive liquid effluent for Cernavoda NPP, the Water Management in force - which establishes the chemicals that may be present in water discharge, discharge route and maximum authorized concentrations and the Agreement signed with ABADL - which identifies the physico-chemical parameters to be analyzed, frequency and sampling points. Through its own Dosimetry Laboratory, the water quality is subject to verifications according to the Radiological Monitoring Program of the radioactive liquid effluent, which identifies the radionuclides that may be present in the discharged water, the discharge path and the maximum concentrations authorized by CNCAN.

3.1.3.1 Radiological characterization of the water environment factor

For the radiological characterization of the water environmental factor for the CTRF site and the area in its vicinity, in an area of up to 30 km, the following were used as resources: information obtained from the environmental radioactivity monitoring program in the vicinity of Cernavoda NPP, and the results of complementary analysis carried out in the period 2020-2021, with the

participation of laboratories designated by CNCAN as test laboratories in the nuclear field, within ICSI Rm. Vâlcea and RATEN ICN Pitești.

The routine environmental monitoring program at Cernavoda NPP was developed and submitted for approval by CNCAN in 1995, and, starting with March 1996, it was implemented, running uninterruptedly throughout the plant's operating period. The monitoring program was last reviewed in January 2019 being approved by CNCAN.

Regarding surface water, the program provides for weekly sampling, followed by monthly compositing and measurement, for two indicator locations and one reference location. The determinations are made to monitor the content of gamma radiation emitting radionuclides, global beta activity and tritium activity concentration. Figure 3.1.3.1.1 shows the evolution of the annual average values of tritium concentration in the surface water samples, according to the Environmental Radioactivity Monitoring Program at Cernavoda NPP.

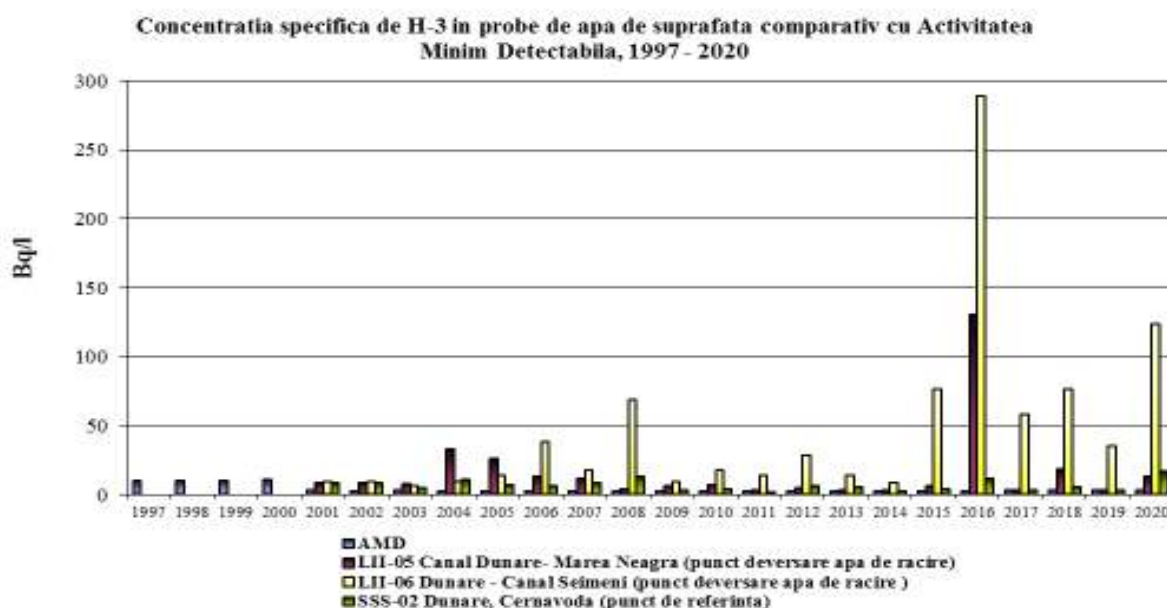

Figure 3.1.3.1.1 Annual average values of tritium concentration in surface water samples

Regarding the concentration of global beta activity in surface water samples, the evolution of the annual averages is shown in Figure 3.1.3.1.2.

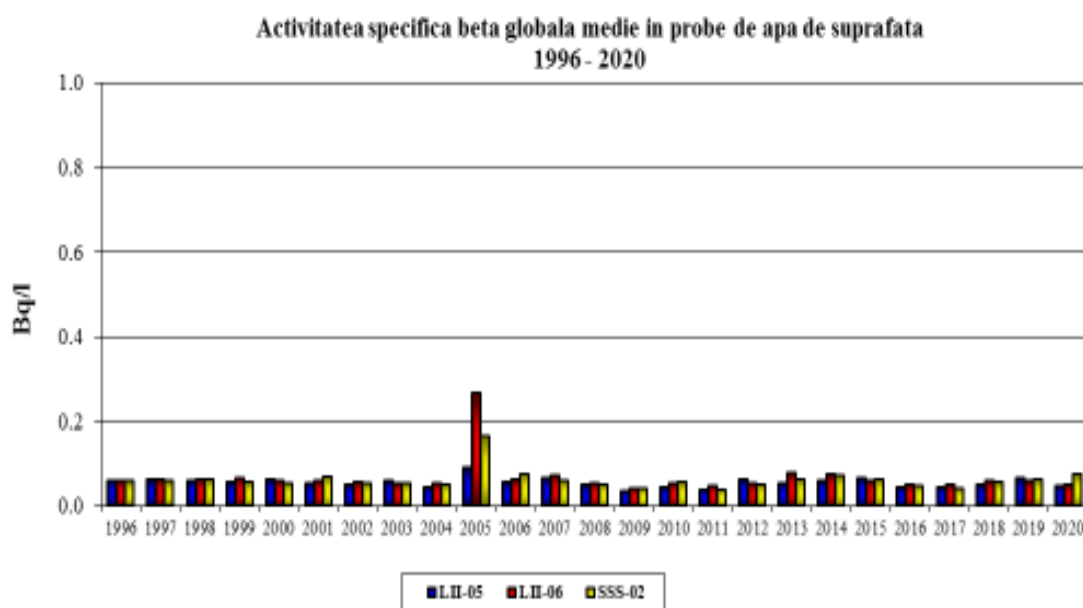

Figure 3.1.3.1.2 Annual average values of global beta activity in surface water samples

Also, the results of gamma spectrometry analysis of surface water samples did not reveal gamma-emitting radionuclides with origin in the activities of Cernavoda NPP.

In the additional monitoring carried out by ICSI Rm. Vâlcea in September 2020, determinations of tritium and C-14 concentration in surface waters were performed, as well as determinations of beta-global and gamma-spectrometric activity concentration, for three samples taken from the Danube. The results of these analyses are presented in the table 3.1.3.1.1.

Table 3.1.3.1.1 Results of the monitoring carried out by ICSI Rm. Vâlcea in September 2020

Sampling location	km 292 Danube (Seimeni)	km 295 Danube	Pod Saligny (Saligny Bridge)
No. of analysis report	134 / 05.11.2020	138 / 05.11.2020	139 / 05.11.2020
H-3 activity concentration (Bq / l)	2.5 ± 0.3	4.1 ± 0.4	2.4 ± 0.3
C-14 activity concentration (Bq / g C)	0.177 ± 0.014	0.221 ± 0.016	0.221 ± 0.016
Global beta activity concentration (Bq / l)	0.05 ± 0.02	0.05 ± 0.02	0.06 ± 0.02
Gamma emitting radionuclide activity concentration (Bq / l)	SLD *	SLD *	SLD *

* SLD- below the detection limit. The detection limit was calculated for a series of gamma-emitting radionuclides specific to Cernavoda NPP and is specified in the analysis reports.

As can be seen, the values of tritium concentration in surface water samples are comparable to the natural background, in the literature they are between 0.6 and 3.6 Bq / l. These values are comparable to the results of the routine monitoring program showing a slight increase in a single monitoring point. Regarding C-14, it is observed that the values of its activity concentration in surface waters in the area of influence of Cernavoda NPP are at the level of the natural background, which in the literature is indicated with a current average value of 238 Bq / kg C (v www.lrsn.fr/EN/Research/publications-documentation/radionuclides-sheets/environment/Documents/Carbone_UK.pdf). The overall beta activity concentration was below 0.1 Bq / l, which confirms the results of the Cernavoda NPP monitoring,

Additional monitoring activities were continued in 2021 by RATEN ICN Pitești through an environmental sampling campaign. The environmental sampling campaign was to determine the content of alpha-emitting radionuclides (actinides), originating from the nuclear activities on the Cernavoda NPP platform. As for the surface waters in this campaign, a sample was taken from the Discharge Canal at Seimeni, and also the actinide concentration from the sediment of the same location was monitored. The results of the analysis of the two samples are presented in Tables 3.1.3.1.2 and 3.1.3.1.3.

Table 3.1.3.1.2 The content of alpha-emitting radionuclides (actinides), originating from the nuclear activities on the Cernavoda NPP platform in the surface water of the Seimeni canal

Measured parameter / Seimeni canal water	Result	Measurement report / issuer
Activity concentration Pu-239/240 (mBq / l)	<0.6	706 / 23.09.2021 RATEN ICN Pitesti
Pu-238 activity concentration (mBq / l)	<0.6	
Am-241 activity concentration (mBq / l)	<0.5	
U-238 activity concentration (mBq / l)	7.7 ± 1.5	
U-235 activity concentration (mBq / l)	<0.7	
U-234 activity concentration (mBq / l)	7.4 ± 1.5	

Table 3.1.3.1.3 The content of alpha-emitting radionuclides (actinides), originating from the nuclear activities on the Cernavoda NPP platform from the sediment of the Seimeni canal

Measured parameter / Sediment Seimeni canal	Result	Measurement report / issuer
Activity concentration Pu-239/240 (mBq / g)	<2.6	713 / 23.09.2021 RATEN ICN Pitesti
Pu-238 activity concentration (mBq / g)	<2.6	
Am-241 activity concentration (mBq / g)	<1.7	
U-238 activity concentration (mBq / g)	20.8 ± 3.8	
U-235 activity concentration (mBq / g)	2.5 ± 1.4	
U-234 activity concentration (mBq / g)	23.1 ± 4.0	

It can be observed that in the surface water samples taken from the vicinity of Cernavoda NPP that no contamination with actinides can be detected, which can be attributed to its operation. The level of concentration of natural uranium isotopes in the samples taken is in the range of variability of the natural background.

As the wastewater from the domestic wastewater collection system on the Cernavoda NPP platform may be sources of surface water pollution, in the monitoring of 2020 and 2021, domestic water samples were taken from a collection tank in the vicinity of the administrative pavilion (approximately 330 m southwest of the CTRF location). Table 3.1.3.1.4 shows the results of the analyses performed on these samples.

Table 3.1.3.1.4 The results of the monitoring from the domestic water network on the Cernavoda NPP platform

Measured parameter / NPP domestic water	Result	Measurement report / issuer
H-3 activity concentration (Bq / l)	3.9 ± 0.4	136 / 05.11.2020 ICSI Rm. Vâlcea
C-14 activity concentration (Bq / g C)	0.096 ± 0.010	
Global beta activity concentration (Bq / l)	0.26 ± 0.07	
Concentration of radionuclide activity gamma emitters (Bq / l)	SLD *	
Pu-239/240 activity concentration (mBq / l)	<0.9	707 / 23.09.2021 ICSI Rm. Vâlcea
Pu-238 activity concentration (mBq / l)	<0.9	
Am-241 activity concentration (mBq / l)	<1.1	
U-238 activity concentration (mBq / l)	4.8 ± 1.2	
U-235 activity concentration (mBq / l)	<0.9	
U-234 activity concentration (mBq / l)	8.1 ± 1.6	

*SLD- below the detection limit. The detection limit was calculated for a series of gamma-emitting radionuclides specific to Cernavoda NPP and is specified in the analysis reports.

The drinking water used in the localities in the vicinity of Cernavoda NPP is monitored in five locations, as follows: All-03 Cernavoda, SSS-03 Saligny, SSS-13 Cernavoda-LCM, SSS-15 Faclia and SSS-16 Seimeni. Also, for the supply of drinking water to the plant, two deep wells are used, the water of which is monitored, in terms of radioactivity content, in the program for monitoring the environment radioactivity (locations SAF-01 and SAF-02).

In the figures 3.1.3.1.3 - 3.1.3.1.5 the average annual values of the concentration of beta-global activity in the drinking water used in the vicinity of Cernavoda NPP and the average annual values of the same parameter for the deep water used as drinking water on the site of the plant are presented.

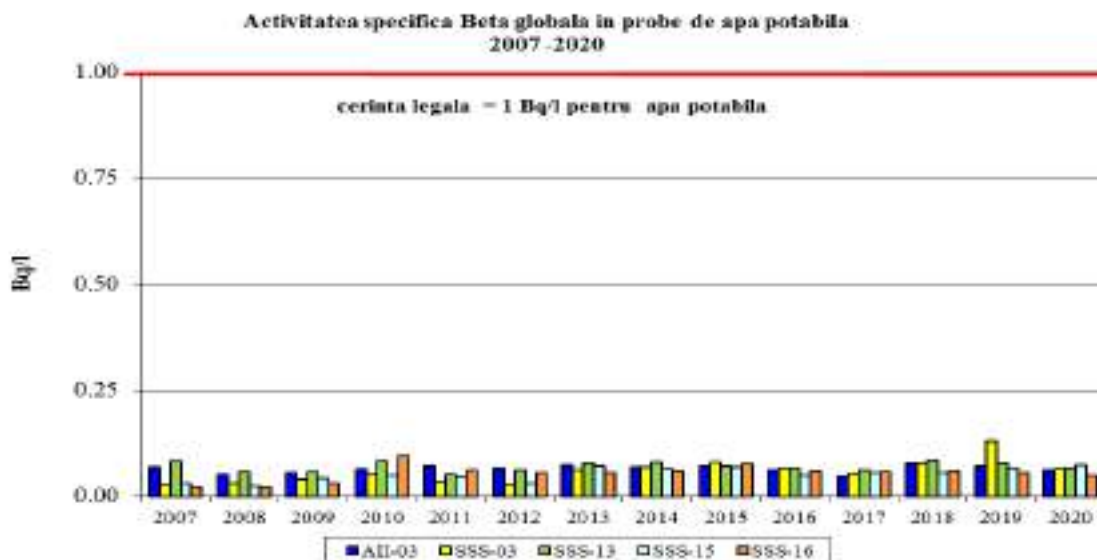

Figure 3.1.3.1.3 Global beta Specific activity in drinking water samples during the period 2007-2020

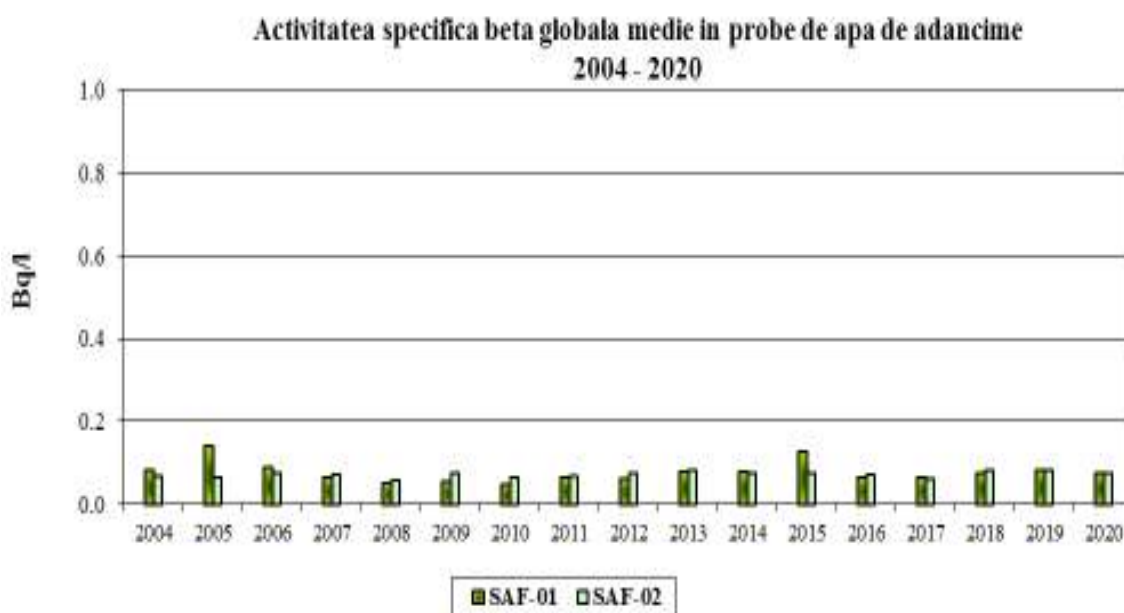

Figure 3.1.3.1.4 Global Beta Specific Activity in Groundwater Samples during the period 2007-2020

The average annual concentration of tritium in drinking water has, over time, been close to the detection limit of 3.03 Bq / l, indicated in the report on the results of the environmental monitoring program. Higher values were recorded for the SSS-16 Seimeni location, downstream of the confluence of the cooling water drainage canal with the Danube river, but these values are well below the legal limit of 100 Bq / l, imposed for drinking water (according to figure 3.1 .3.1.5). Regarding the concentration of tritium in the deep groundwater, the report shows that no values higher than the limit of detection (3.14 Bq / l) were recorded in the samples taken between 2004 and 2020.



Figure 3.1.3.1.5 Specific concentration of H-3 in drinking water samples in the period 2007-2020

In the monitoring campaigns of 2020 and 2021, drinking water and deep groundwater were characterized from a radiological point of view by taking samples from the locations of LCM (Cernavoda drinking water supply network) and on-site drilling. The results of the analysis are presented in table 3.1.3.1.5.

Table 3.1.3.1.5 Monitoring results from drinking water and deep groundwater

Measured parameter	LCM drinking water	Groundwater on-site drilling
H-3 activity concentration (Bq / l)	<0.4	<0.4
C-14 activity concentration (Bq / g C)	0.204 ± 0.016	0.026 ± 0.006
Global beta activity concentration (Bq / l)	<0.03	0.06 ± 0.03
Concentration of radionuclide activity gamma emitters (Bq / l)	SLD *	SLD *
Number of ICSI Rm. Vâlcea analysis report	135 / 05.11.2020	137 / 05.11.2020
Pu-239/240 activity concentration (mBq / l)	<0.7	<0.8
Pu-238 activity concentration (mBq / l)	<0.7	<0.8
Am-241 activity concentration (mBq / l)	<0.9	<0.8
U-238 activity concentration (mBq / l)	13.5 ± 2	8.9 ± 1.6
U-235 activity concentration (mBq / l)	<0.7	<0.7
U-234 activity concentration (mBq / l)	23.9 ± 2.9	6.8 ± 1.3
RATEN ICN Pitesti analysis report number	704 / 23.09.2021	705 / 23.09.2021

It can be noticed that the sources of drinking water in the vicinity of Cernavoda NPP do not show a contamination with actinides, which can be attributed to its operation. The level of concentration of natural uranium isotopes in the samples taken is in the range of variability of the natural background.

In the mathematical modeling of the transfer of radionuclides from source to human receptor, the dispersion of radioactive pollutants in the aquatic environment is based on the hypothesis of total

dilution of the pollutant, before the location where the population can use the water resource. From the above, it can be noticed that in the case of Cernavoda NPP, this hypothesis is fulfilled. Under these conditions, the transfer parameter P_{02} that binds the concentration of the radionuclide of interest, in water (X_2) at a certain location to the evacuation flow, X_0 (w) is defined. This parameter is thus given by the equation:

$$P_{02} = \frac{X_2}{X_0(w)} = \frac{\beta}{D_F \cdot Q_V} \cdot e^{-\lambda_d \cdot T} \quad (s \cdot L^{-1})$$

Where:

Q_V = average annual liquid effluent discharge rate (L s⁻¹)

D_F = dilution factor

β = effluent recirculation factor

$\lambda_d = \lambda_r + \lambda_c$ (s⁻¹)

λ_r = radioactive decay constant

λ_c = sediment removal constant

T = transport time from the point of evacuation to the point of water use (s)

For conservative purposes, when no specific data is available for the retention of radionuclide by sedimentation, the value of λ_c is considered $\lambda_c = 0$, and $\lambda_d = \lambda_r$.

The dilution factor, D_F , is the report between the average effluent concentration at the point of evacuation and the average concentration at the point of water use. For evacuation in the Danube - Black Sea Canal, it does not have a significant flow for diluting liquid evacuations. Therefore, the D_F will be 1. The main dilution of radioactive liquid evacuations takes place at the evacuation into the Condenser Cooling Water Channel.

The recirculation factor, β , accounts for the increase in the concentration of radionuclide in the effluent, by accumulation, when part of the evacuated water is recirculated. If the evacuated water is not recirculated, $\beta = 1$. For cold periods, when recirculating, $\beta = 1 / (1-f_r)$, with f_r = recirculation fraction.

The transport time from the place of evacuation to the point of use is of 0 s for Cernavoda and 2.53×10^5 s for Constanta (1 day for transport and 2 days of delay due to water treatment and distribution stations). For evacuations in the Danube (water use by people from Seimeni) the transport time is considered 0 s for conservative reasons. The average annual effluent flow rate of liquid effluent, Q_V , is 5.38×10^4 L s⁻¹ [3].

Using the calculation model above, the dispersion parameters for H-3 and C-14 radionuclides of interest to CTRF are estimated to be:

Table 3.1.3.1.6 Dispersion parameters for H-3 and C-14 radionuclides

Radionuclide	Dispersion parameter P_{02} (s · L ⁻¹)		
	Cernavoda	Constanța	Seimeni
H-3	1.86E-05	1.86E-05	3.85E-07
C-14	1.86E-05	1.86E-05	3.85E-07

3.1.3.2 Water use

Cernavoda NPP uses 3 authorized sources of drinking water, two located inside and one located in the NPP Campus area [1]:

Fj1 H = 700 m; Nhs = 4m; Nhd = 10m; Q = 16 l / s;

Fj2 H = 700 m; Nhs = 3.1m; Nhd = 5m; Q = 28.5 l / s;

Fj3 H = 700 m; Nhs = 5.17m; Nhd = 5.92m; Q = 21.2 l / s

The necessary drinking water of Cernavoda NPP is provided from the 2 boreholes located on the NPP site.

The reserve source for drinking water is provided by the Cernavoda city's drinking water supply system [1].

The provision of the necessary technological (industrial) water is made from the surface waters of the Danube - Pond I of the Danube - Black Sea Canal, through the bypass canal [1].

The provision of the necessary water for extinguishing fires is made from the surface waters of the Danube - Pond I of the Danube - Black Sea Canal, through the bypass canal after passing through a 5 mm diameter mesh filter [1].

3.1.4 Liquid effluent evacuation point

The evacuation of non-radioactive liquid effluent is achieved by using 3 evacuation routes:

1. Non-radioactive domestic wastewater is evacuated into the sewer network of the city of Cernavoda. Domestic wastewater from the Cernavoda NPP platform reaches the Cernavoda Wastewater Treatment Plant, which evacuates the treated wastewater through the Seimeni evacuation canal into the Danube (Cernavoda NPP cooling water canal), the outlet point being before the cooling water evacuation into the Danube [116].

2. Rainwater is evacuated in the distribution basin of Cernavoda NPP and includes discharges from underground drainage, inactive drainage from the turbine building, reactor buildings U1 and U2, buildings of Diesel groups - backup generator SDG (Stand-by Diesel Generator) U1 and U2, siphon basin 1 (2), Thermal Start-up Plant (CTP), the waters resulting from the washing of the STA mechanical filters, the wastewater from the fuel oil separator, from the overflow of the demineralized water tank, from the overflow of the filtered water tank [116].

3. Technological wastewater resulting from condensers and auxiliary coolers in the engine room (U1 + U2), chemically treated wastewater and wastewater with medium and low radioactivity - passed (if necessary) through contamination diminution installations are evacuated, in normal operating situations, in the Danube river (hectometer 779) and with the approval of the "Apele Române" National Administration and of Dobrogea-Seaside Water Basin Administration („Administrația Bazinală de Apă Dobrogea – Litoral") as well as with the acceptance / approval / notification of the other competent authorities according to the legal provisions (authorities within the Ministry of Health, etc.) in the Danube - Black Sea Canal (Pond 2 - hectometer 594) [116].

In case of emergency, the technological wastewater is evacuated into the Danube - Black Sea Canal (Pond 1 - hectometer 611) [116].

Physico-chemical characterization of the effluent

The physico-chemical characterization of the effluent is based on the average annual results obtained by the monitoring program carried out by Cernavoda NPP - through its own Chemical Laboratory and through third-party specialized laboratories. The results of the physico-chemical parameters for the effluent are presented in the figures 3.1.4.1 - 3.1.4.12. The analysis of these results shows that the monitored parameters showed values below the maximum allowed concentrations.

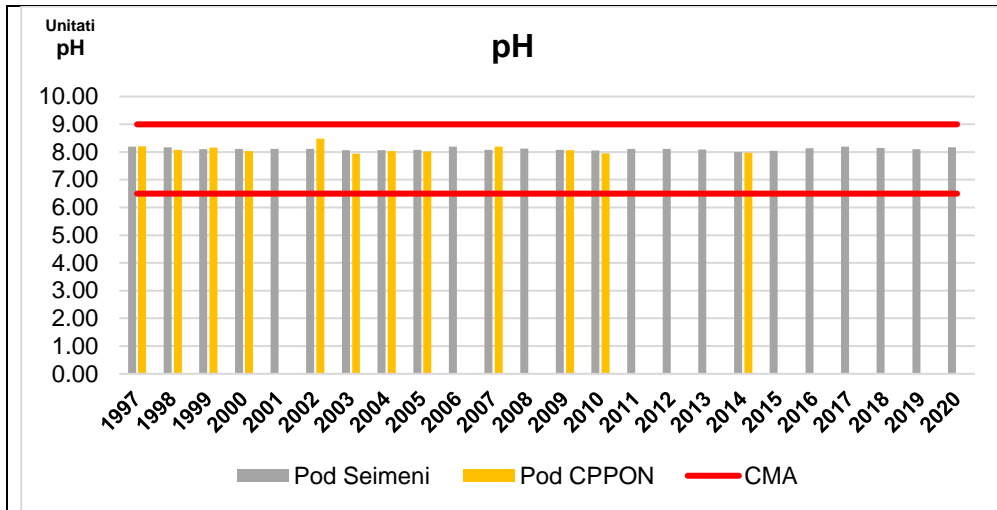

Figure 3.1.4.1. Annual average pH values in liquid effluent

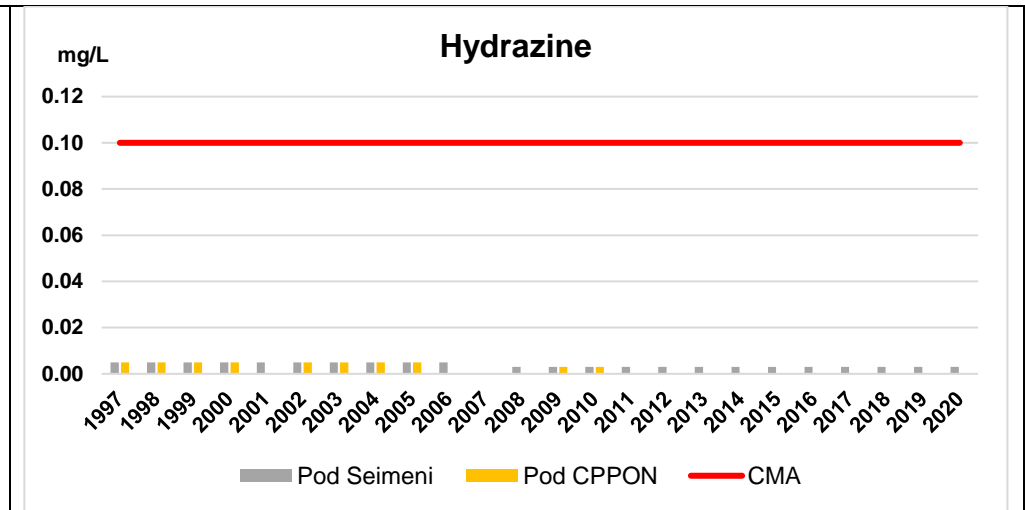

Figure 3.1.4.2. Annual average values for hydrazine concentration in the liquid effluent

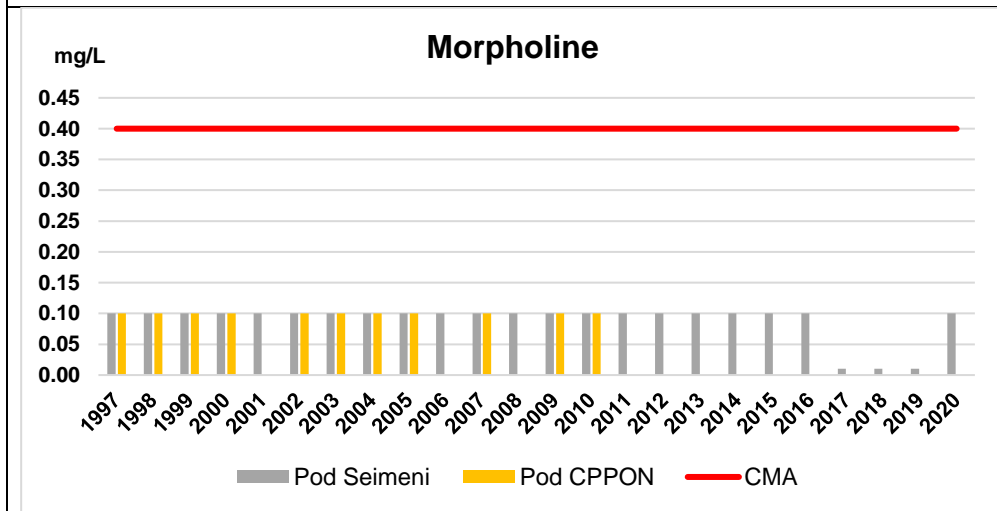

Figure 3.1.4.3. Annual average values for morpholine concentration in the liquid effluent

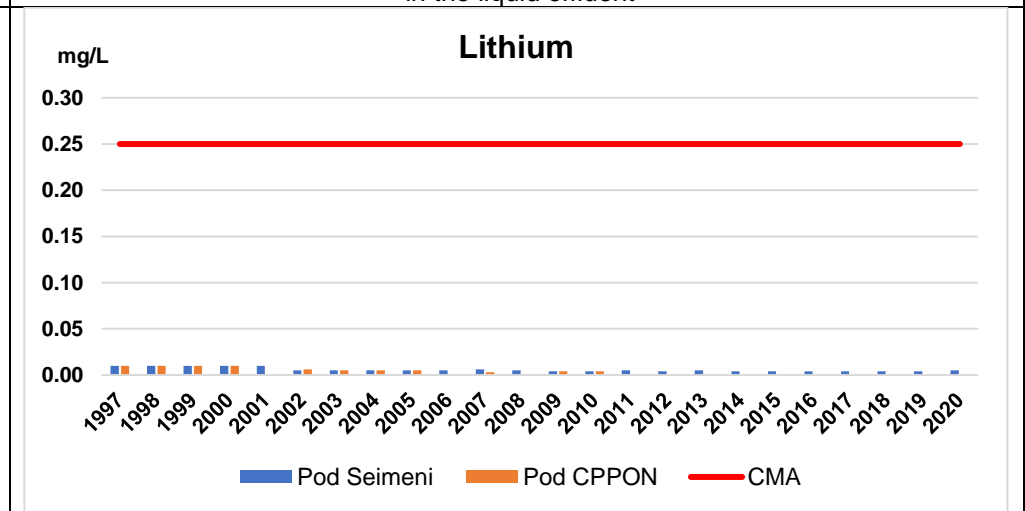

Figure 3.1.4.4. Annual average values for lithium concentration in the liquid effluent

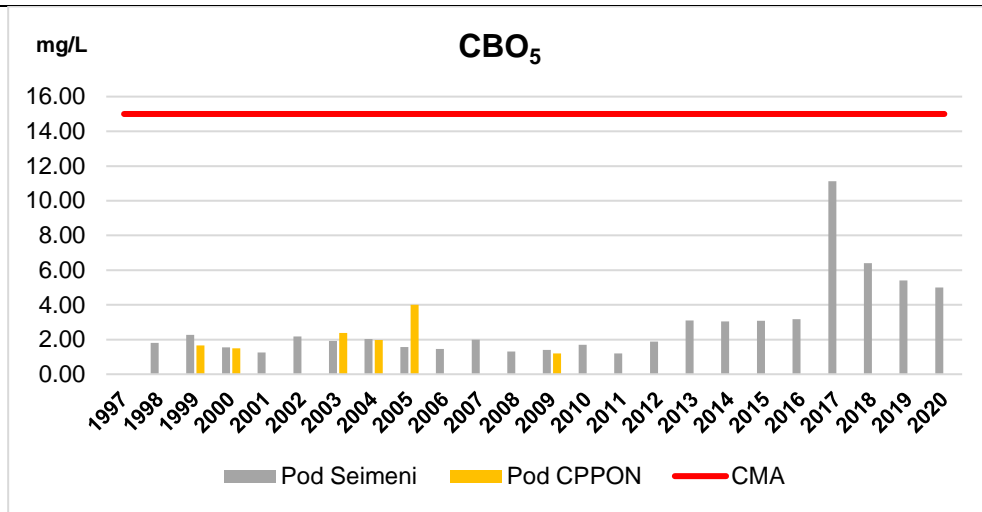

Figure 3.1.4.5. Annual average values for the concentration of biochemical oxygen consumption in the liquid effluent

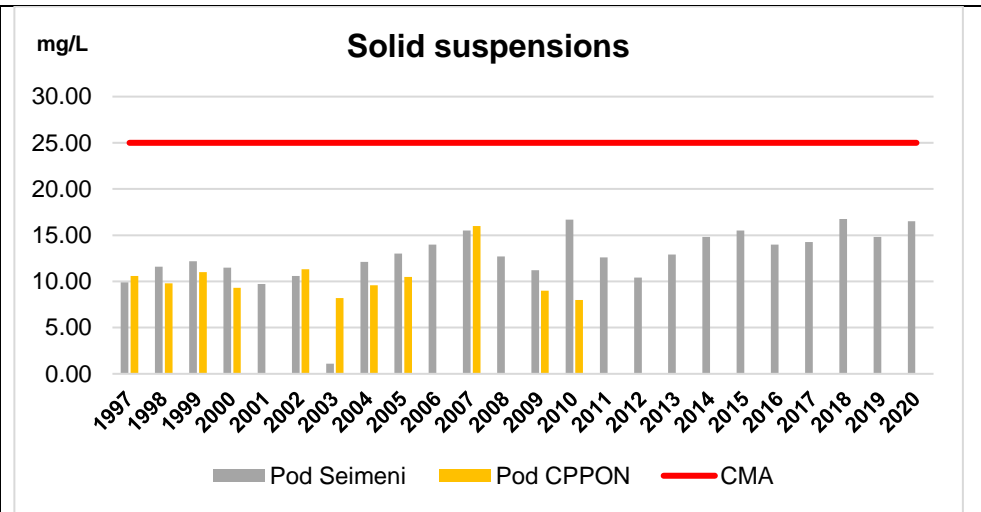

Figure 3.1.4.6. Annual average values for the concentration of solid suspensions in the liquid effluent

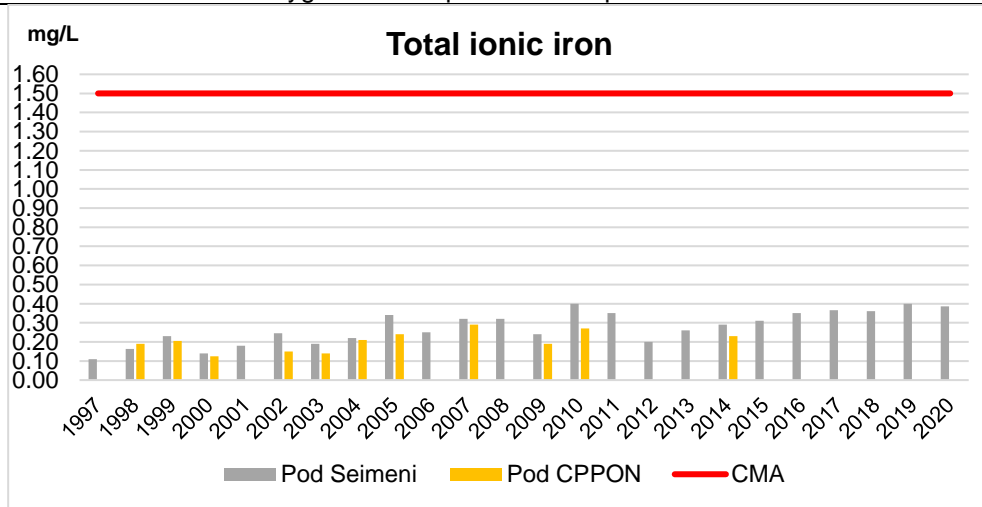

Figure 3.1.4.7. Annual average values for the concentration of solid suspensions in the liquid effluent

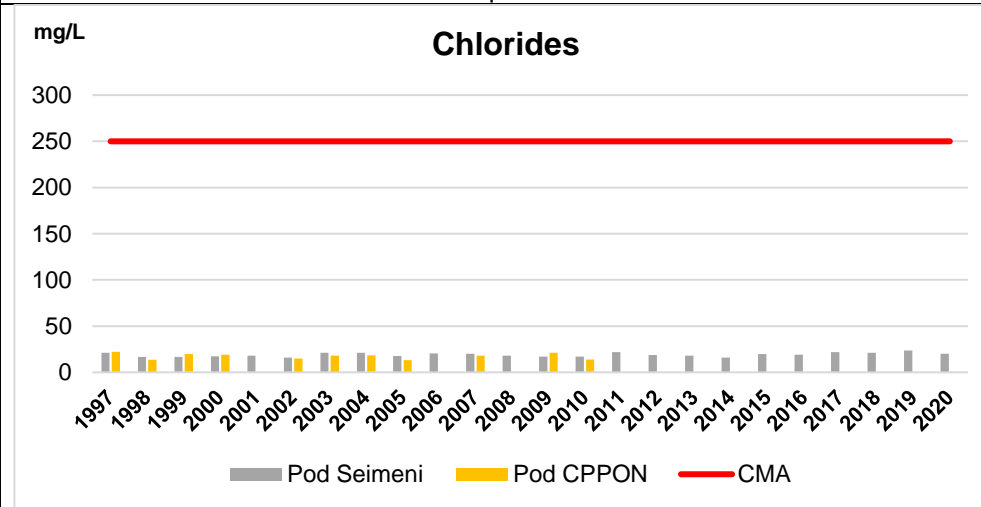

Figure 3.1.4.8. Annual average values for chloride concentration in the liquid effluent

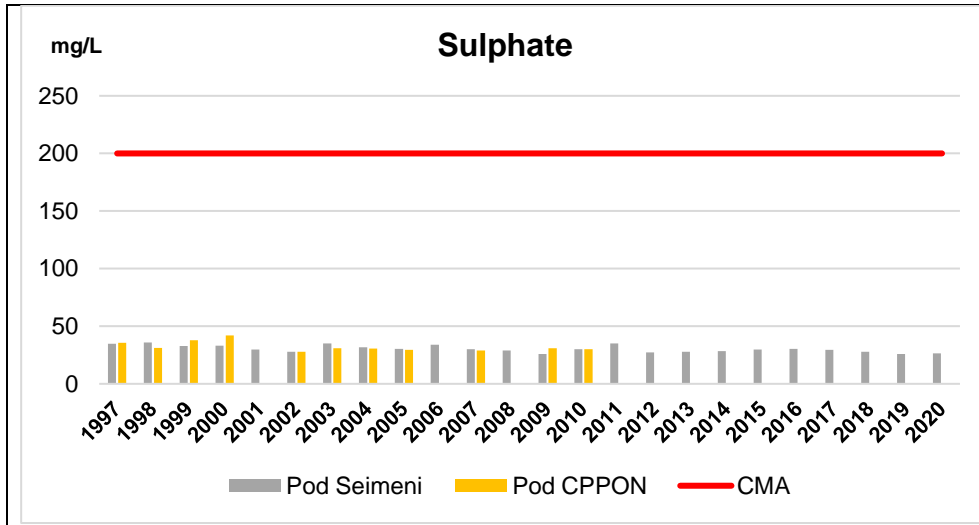

Figure 3.1.4.9. Annual average values for sulphate concentration in the liquid effluent

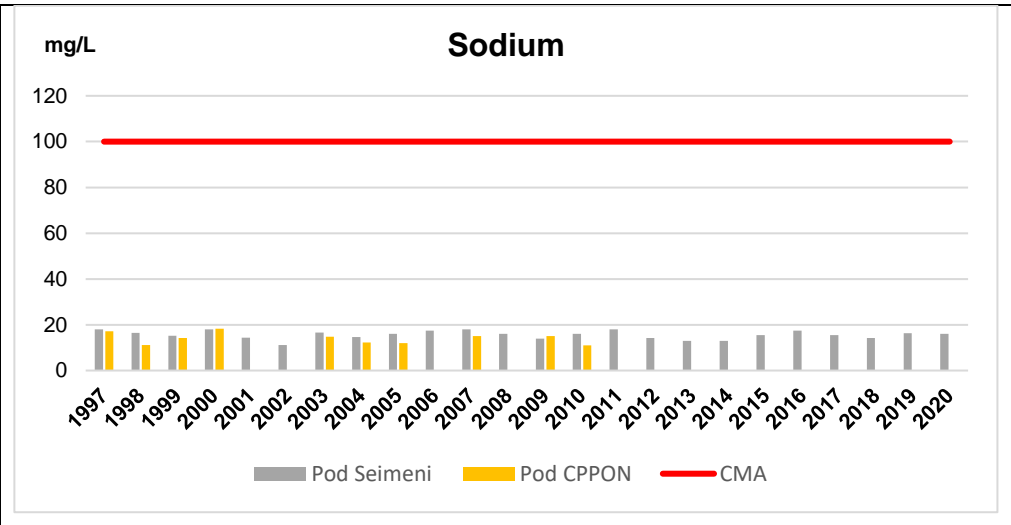

Figure 3.1.4.10. Annual average values for sodium concentration in the liquid effluent

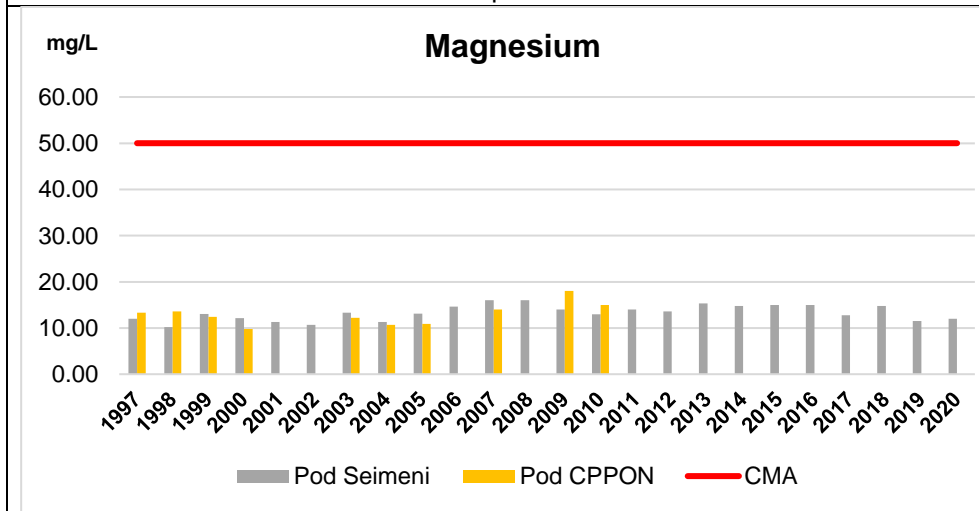

Figure 3.1.4.11. Annual average values for magnesium concentration in the liquid effluent

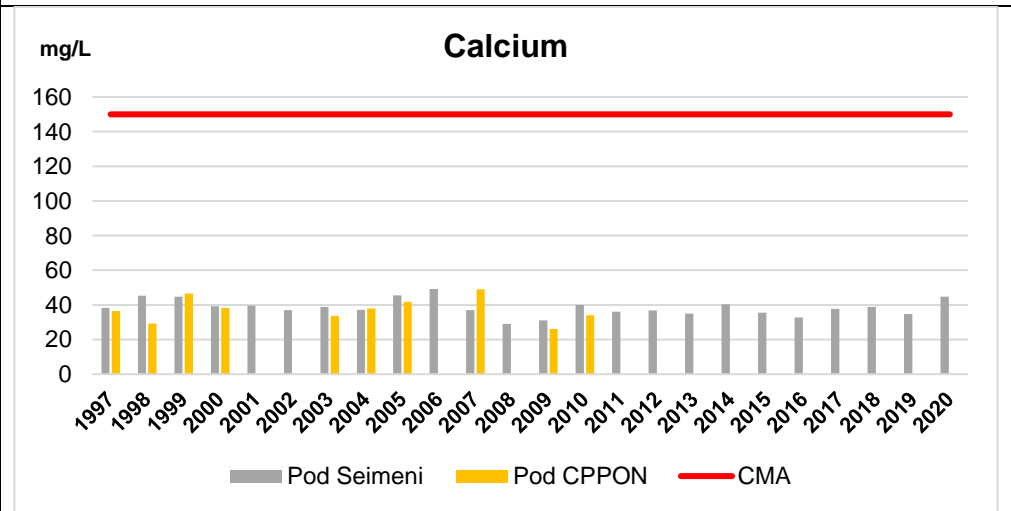

Figure 3.1.4.12. Annual average values for calcium concentration in the liquid effluent

3.1.5 Water sources that may be affected by the project

The CTRF project will bring a wastewater supply to the domestic sewerage system of Cernavoda NPP. Based on the quantitative estimates of the CTRF wastewater supply in Chapter 1, this volume of domestic wastewater will increase insignificantly. Therefore, it is estimated that by the normal operation of the CTRF installation, the temperature and the supply of nutrients discharged into the emissary (after purification) will not change significantly compared to the current discharges from the NPP.

From a radiological point of view, there is a risk that in the operations of decontamination of surfaces and general cleaning activities, respectively, cleaning of surfaces and equipment, discharges of liquid effluents will show radioactive charge. If the cleaning water is radioactive, it will be directed to the active drainage system, which will then be transferred to Unit 1.

3.2 The air environment factor

The air is the environmental factor that constitutes the fastest support that favors the transport of pollutants in the environment. Air quality is determined by air emissions from stationary and mobile sources (road traffic), as well as long-distance transport of air pollutants. In Romania, the field of "air quality" is regulated by Law 104/2011. According to the MMAP Guide, updated data on airborne radioactivity concentrations in the Cernavoda NPP area, in particular tritium and carbon 14, are presented.

Air quality in Cernavoda NPP area

In accordance with Order 2202/2020 on the approval of the lists with the administrative-territorial units drawn up following the classification in the management regimes of the surfaces in the areas and agglomerations provided in annex no. 2 to Law no.104/2011 on ambient air quality, Constanța county is included in the management regime II. This regime represents the surfaces in areas and agglomerations where the levels for sulfur dioxide, nitrogen dioxide, nitrogen oxides, PM₁₀ and PM_{2.5} particulate matter, lead, benzene, carbon monoxide are below the limit values, respectively for arsenic, cadmium, nickel, benzo(a)pyrene, PM_{2.5} particulate matter are lower than the objective values set by law.

The assessment of the air quality carried out in the Cernavoda NPP area shows the following values of the background concentrations in the area in the vicinity of the site [8]:

- NO₂ – annual average – 13,66 µg/m³
- NO_x – annual average – 13,52 µg/m³
- CO – dynamic average in 8h – 582,30 µg/m³
- PM₁₀ – maximum daily values – 24,16 µg/m³
- PM₁₀ – annual average – 21,37 µg/m³
- PM_{2,5} – annual average – 17,52 µg/m³
- SO₂ – maximum hourly values – 36,31 µg/m³
- SO₂ – maximum daily values – 14,30 µg/m³
- SO₂ – annual average – 3,92 µg/m³
- C₆H₆ – annual average – 0,25 µg/m³
- As – annual average – 0,78 ng/m³
- Cd – annual average – 0,20 ng/m³
- Ni – annual average – 0,83 ng/m³
- Pb – annual average – 8,11 ng/m³

Reporting the values of the background concentrations does not indicate exceedances of the limit values for any of the pollutants analyzed, for all mediation periods.

3.2.1 Radiological characterization of the air environment factor

For the monitoring of air radioactivity, the environmental radioactivity monitoring program from Cernavoda NPP provides monthly sampling from 11 indicator locations and a reference location (Table 3.2.1.1), in order to determine the concentration of alpha / beta-global activity in aerosols and the concentration of tritium in the air.

Table 3.2.1.1 Location of sampling points

Location code	Location	Remarks
ADI-01	Tortomanu	SC Cezotor
ADI-02	Gherghina	COMPET
ADI-03	Medgidia	Weather Station - used since 2012
ADI-04	Mircea Voda	Gara CFR
ADI-05	Saligny	Gendarmerie unit
ADI-06	Cernavodă	Canal lock - used until 2012
ADI-07	Fetesti	Weather station - used since 2012
ADI-08	Cernavoda	Environmental Control Laboratory
ADI-09	Seimeni	Veterinary Dispensary
ADI-10	Rasova	Police Station
ADI-11	Cernavoda	Station 400 Kv
ADI-12	Cernavoda	DIDSR
ADI-13	Cernavoda	DICA
ADB-01	Topalu	Police Station

Note: Regarding the ADI-03, ADI-06 and ADI-07 locations, the changes were made as a result of a revision of the Monitoring Program.

The program also provides monthly sampling from three locations to determine the concentration of C-14 in the air.

The figures 3.2.1.1 - 3.2.1.4 present the average annual values of the concentration of global beta activity in the aerosol samples over the entire period of the operational monitoring program.

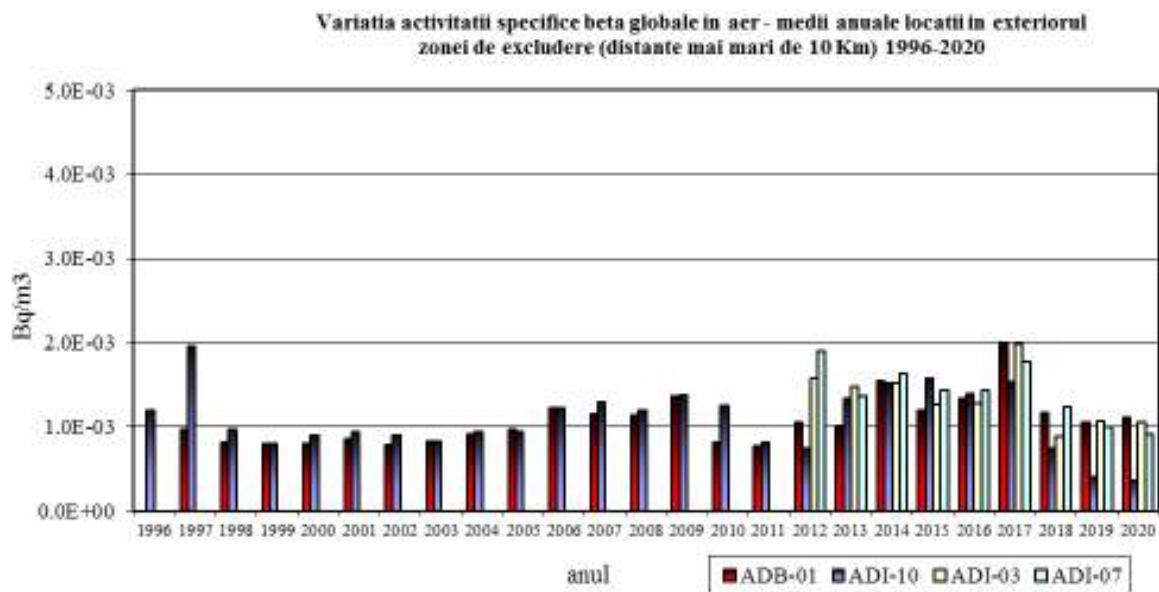

Figure 3.2.1.1 Annual average values for the variation of the specific global beta activity in the air for distances exceeding 10 km

Variatia activitatii specifice beta globale in aer - medii anuale locatii in exteriorul zonei de excludere la distante cuprinse intre 5 Km si 10 Km de amplasament 1996-2020

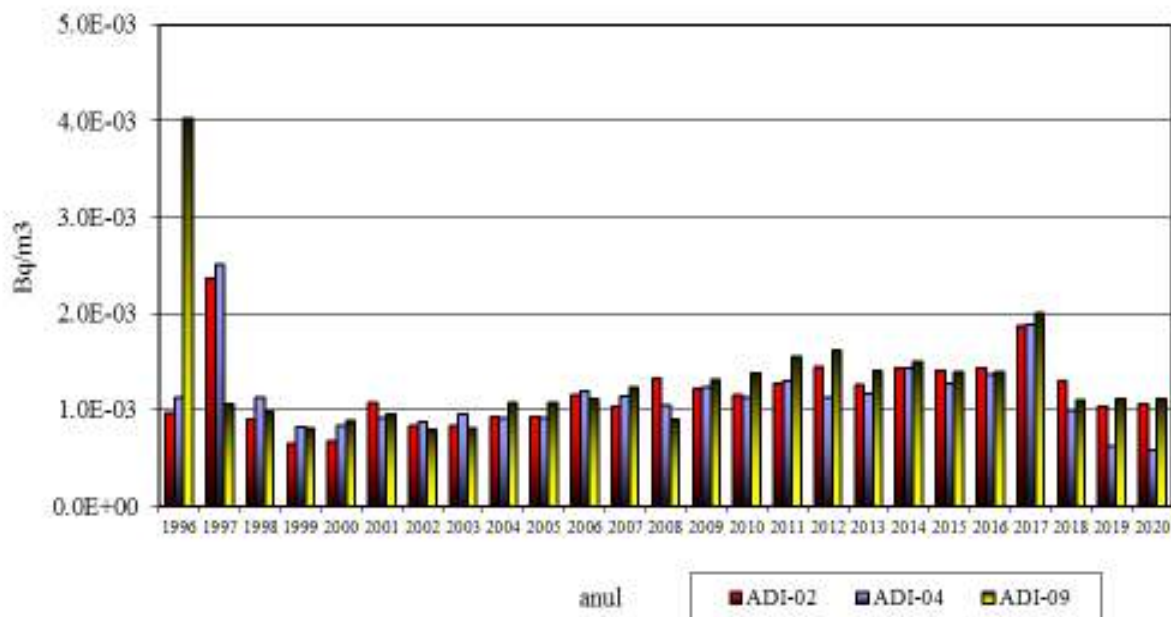

Figure 3.2.1.2 Annual average values for the variation of the specific global beta activity in the air for distances between 5 km and 10 km

Variatia activitatii specifice beta globale in aer - medii anuale locatii in exteriorul zonei de excludere la o distanta cuprinsa intre 1 km si 5 km de amplasament 1996-2020

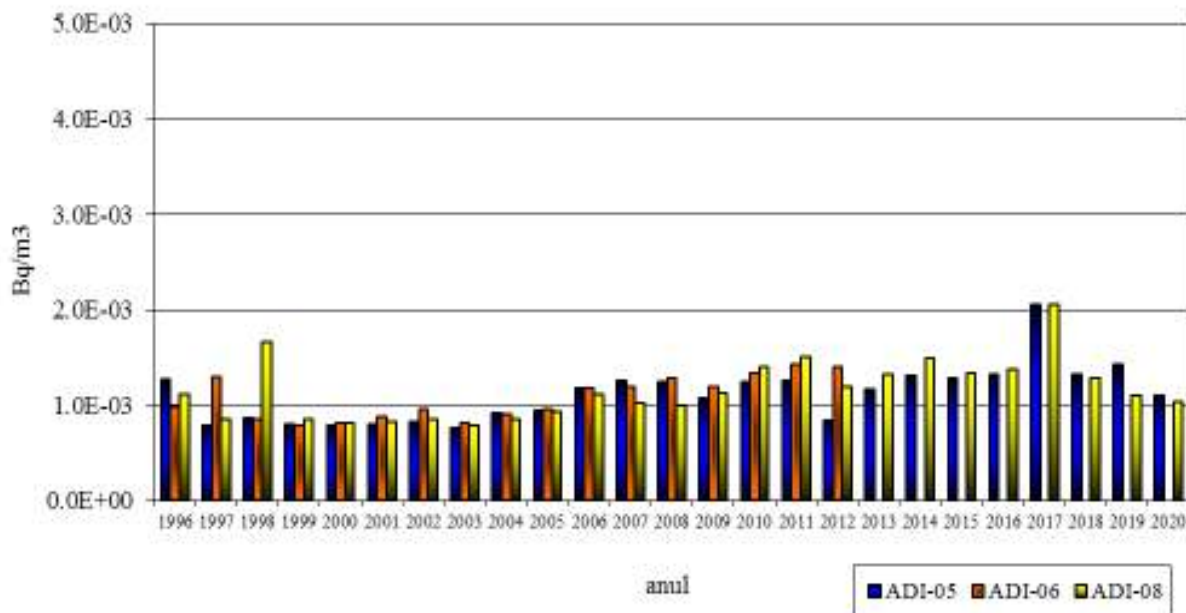

Figure 3.2.1.3 Annual average values for the variation of the specific global beta activity in the air for distances between 1 km and 5 km

Variatia activitatii specifice beta globale in aer - medii anuale locatiei pe amplasament
 (in interiorul zonei de excludere) 1996-2020

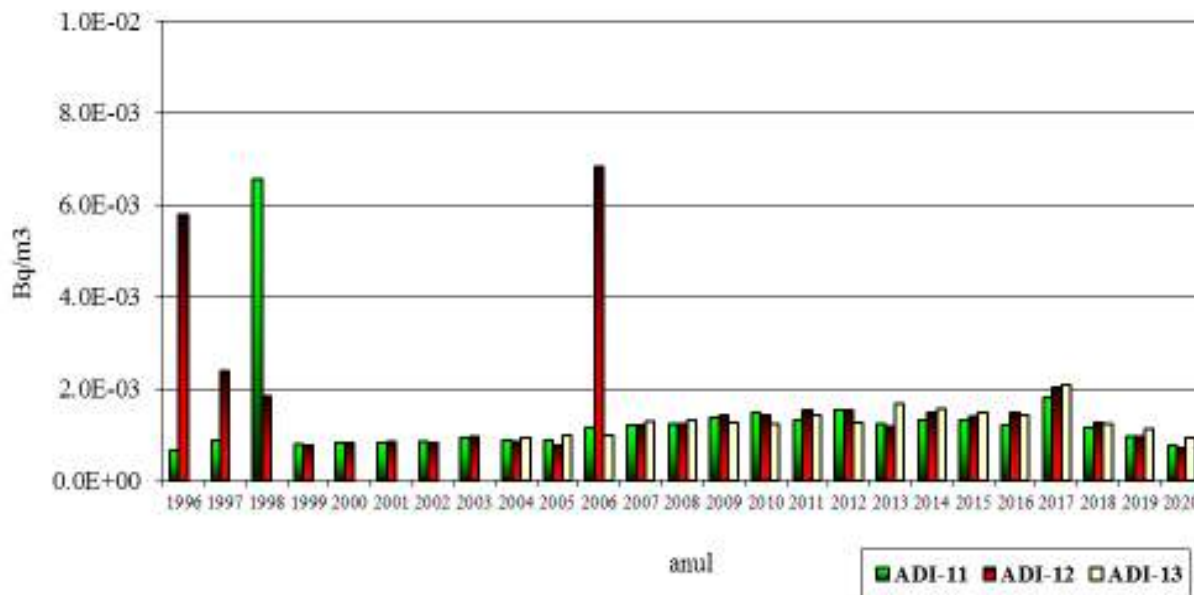

Figure 3.2.1.4 Annual average values for the variation of the specific global beta activity in the air for the exclusion zone

As can be seen from the graphs presented above, the level of concentration of global beta activity in aerosol samples taken in the vicinity of Cernavoda NPP remained very low, comparable to the natural background of radioactivity in the air, at ground level, the increase in 2006 being caused by excavation work on the DIDSr site. Regarding the concentration of global alpha activity, the environmental radioactivity monitoring report shows that it had values ranging between 22 microBq / m³ and 256 microBq / m³, being in full accordance with the range of variability of the natural background. [84].

In 2021, the analyses carried out by RATEN ICN Pitești, aerosol samples were taken from four locations located in the vicinity of the CTRF site, and the global beta activity concentrations and the concentration of the activity of gamma radiation emitting radionuclides were also among the determined parameters. Table 3.2.1.2 presents the results of the analyses regarding the global beta activity concentration:

Table 3.2.1.2 Global beta activity and concentration activity of gamma radiation emitting radionuclides from locations in the vicinity of the CTRF site

Sample name	Measurement report	Concentration (Bq / mc)	MDC (Bq / mc)
DIDSr aerosol filter	624 / 30.08.2021	0.058	0.007
LCM aerosol filter	625 / 30.08.2021	0.011	0.001
CTRF aerosol filter	626 / 30.08.2021	0.049	0.006
PCA aerosol filter	627 / 30.08.2021	0.022	0.003

Following gamma spectrometry measurements of the aerosol samples, no gamma radiation emitting radionuclides above the detection limit were detected. Table 3.2.1.3 shows the minimum detectable activity (AMD) values for a series of NPP-specific gamma-emitting radionuclides, calculated under the specific sampling and measurement conditions, for each sample.

Table 3.2.1.3 Gamma-emitting radionuclides, specific to Cernavoda NPP

Radionuclide	AMD (Bq / mc)			
	DIDSR	LCM	CTRF	PCA
K-40	0.87	0.17	0.84	0.34
Cr-51	0.31	0.06	0.30	0.12
Mn-54	0.03	0.01	0.03	0.01
Co-58	0.03	0.01	0.04	0.01
Co-60	0.05	0.01	0.05	0.02
Zn-65	0.10	0.02	0.10	0.04
Nb-95	0.03	0.01	0.03	0.01
Zr-95	0.06	0.01	0.06	0.02
Ru-103	0.03	0.01	0.03	0.01
Ru-106	0.30	0.05	0.29	0.11
Sb-124	0.03	0.01	0.03	0.01
Sb-125	0.09	0.02	0.09	0.04
Cs-134	0.03	0.01	0.03	0.01
Cs-137	0.04	0.01	0.04	0.01
Ce-139	0.04	0.01	0.04	0.02
Ba-140	0.11	0.02	0.11	0.04
Ce-141	0.06	0.01	0.06	0.02
Ce-144	0.24	0.05	0.23	0.09
Eu-152	0.24	0.04	0.24	0.10
Gd-153	0.05	0.01	0.06	0.02
Eu-154	0.06	0.01	0.06	0.02
No. of Measurement report	620 / 30.08.2021	621 / 30.08.2021	622 / 30.08.2021	623 / 30.08.2021

The results of the content determination of the alpha-emitting radionuclides (actinides) in aerosol samples are given in Table 3.2.1.4.

Table 3.2.1.4 Results of determinations of alpha-emitting radionuclides (actinides)

Measured parameter	LCM	CTRF	DIDSR	PCA
Activity concentration Pu-239/240 (mBq / m ³)	<0.4	<1.1	<1.1	<0.6
Activity concentration Pu-238 (mBq / m ³)	<0.4	<1.1	<1.1	<0.6
Activity concentration Am-241 (mBq / m ³)	<0.4	<1.5	<1.9	<0.8
Activity concentration U-238 (mBq / m ³)	<1.2	5.6 ± 2.9	15.9 ± 9.7	<2.3
Activity concentration U-235 (mBq / m ³)	<1.2	<3.8	<14.4	<2.3
Activity concentration U-234 (mBq / m ³)	<1.2	<3.8	<14.4	<2.3
RATEN ICN Pitesti analysis report number	709 / 23.09.2021	710 / 23.09.2021	711 / 23.09.2021	712 / 23.09.2021

The higher detection limit values indicated for CTRF and DIDSR locations are due to the lower volumes of air drawn in these locations, due to the operation of the sampling equipment in autonomous mode (on batteries). However, ***the high level of sensitivity of the method allowed to highlight that on the site of Cernavoda NPP and in its immediate vicinity there is no contamination of the air with actinides which can be attributed to the operation of the plant.*** The average annual concentrations of tritium in the air in the vicinity of Cernavoda NPP, as recorded in the environmental radioactivity monitoring program, are shown in Figures 3.2.1.5 - 3.2.1.8.

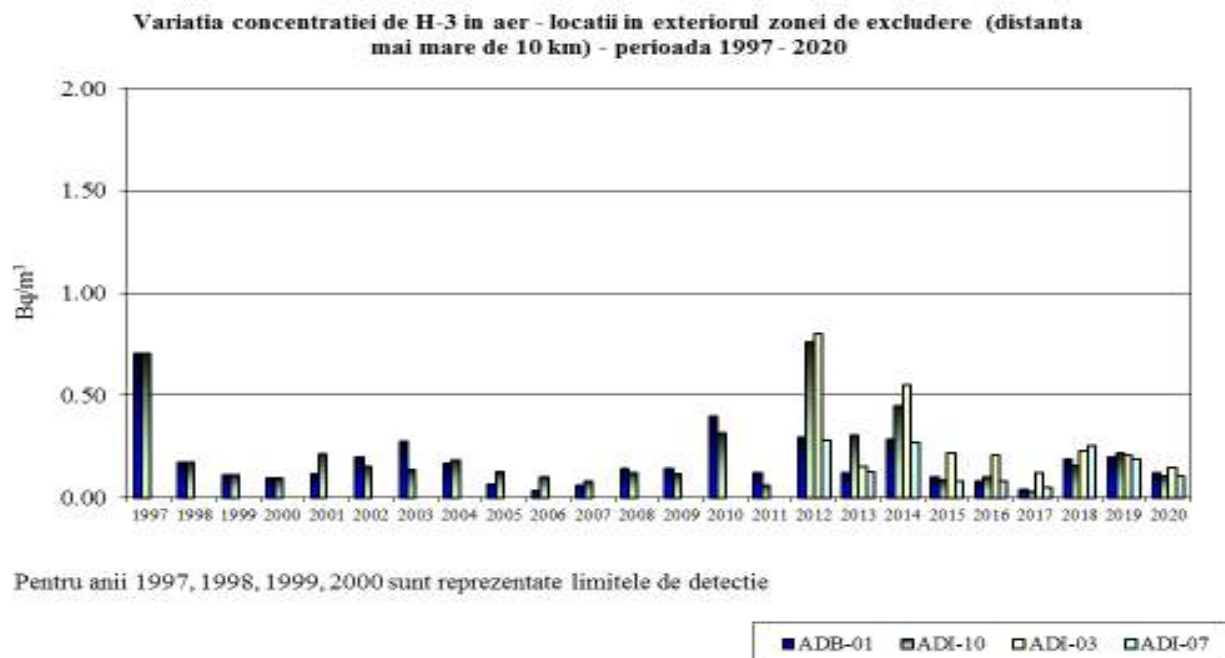

Figure 3.2.1.5 Variation in the concentration of H-3 in the air for distances exceeding 10 km.

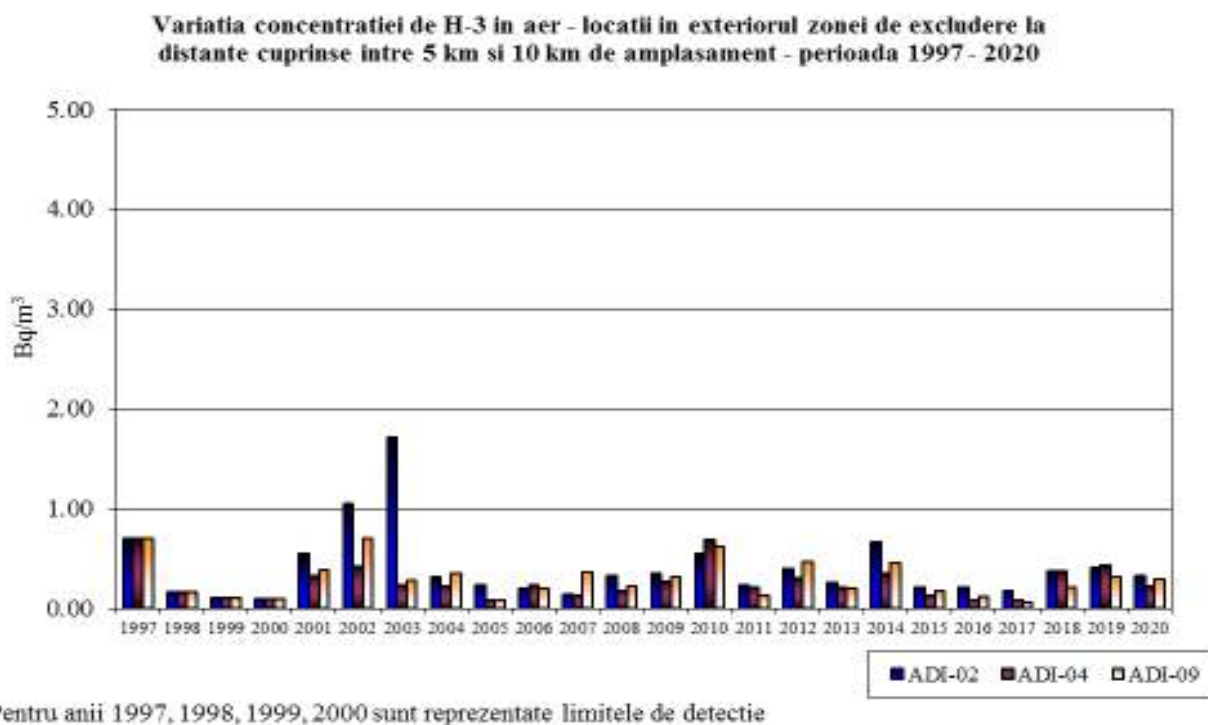

Figure 3.2.1.6 Variation in the concentration of H-3 in the air for distances between 5 km and 10 km

Variatia concentratiei de H-3 in aer - locatii din exteriorul zonei de excludere la o distanta cuprinsa intre 1 km si 5 km de amplasament - perioada 1997 - 2020

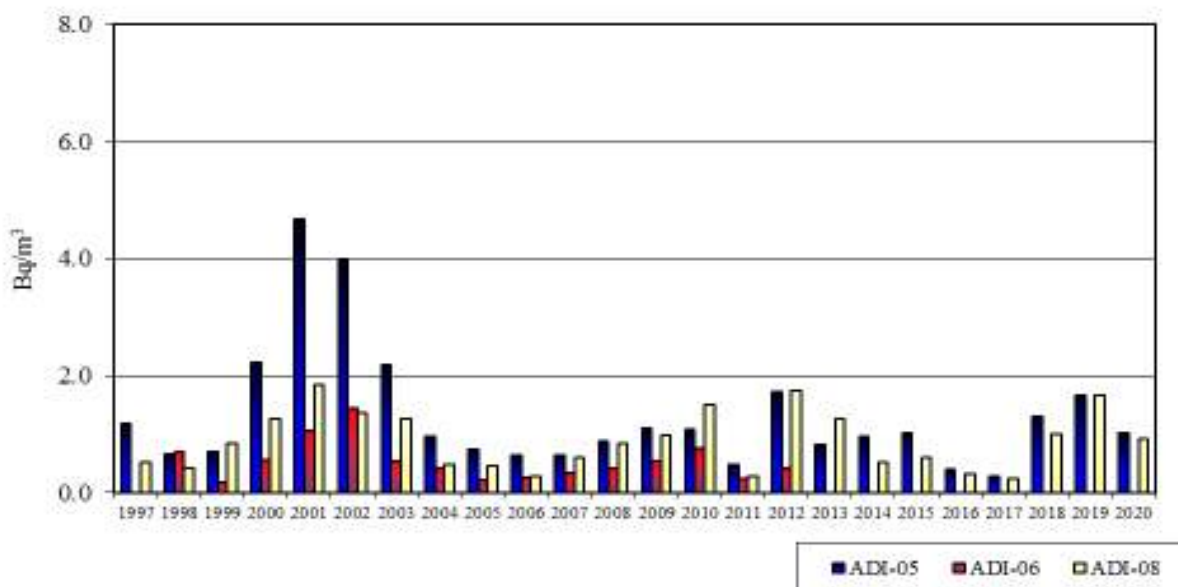

Figure 3.2.1.7 Variation in the concentration of H-3 in the air for distances between 1 km and 5 km

Variatia concentratiei de H-3 in aer - locatii pe amplasament (in interiorul zonei de excludere) - perioada 1997 - 2020

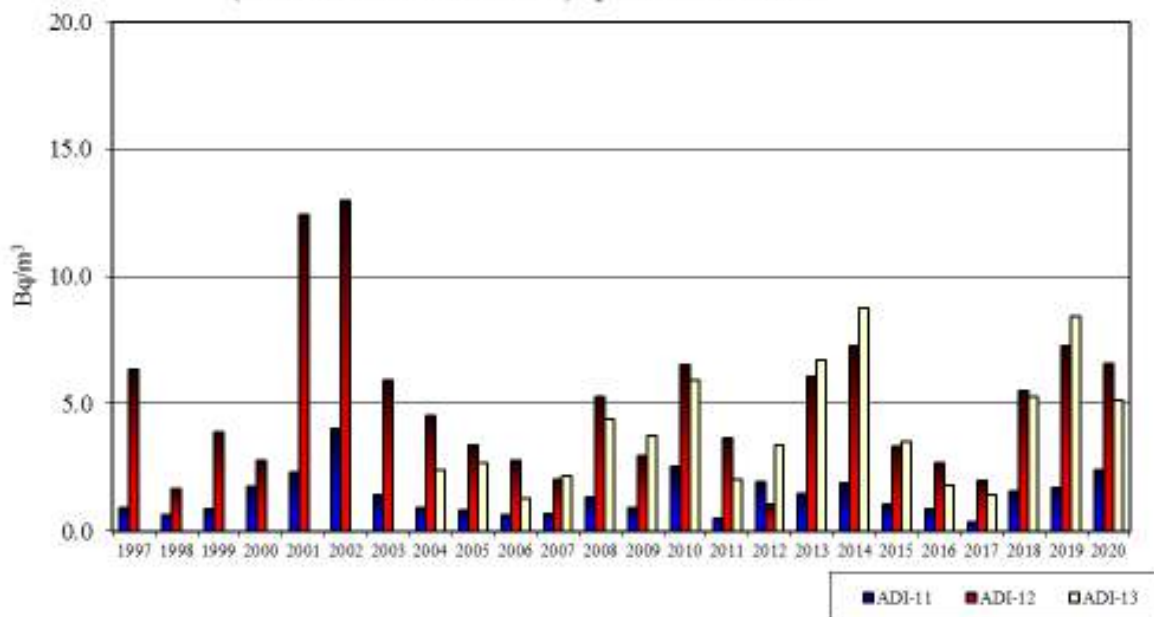

Figure 3.2.1.8 Variation in the concentration of H-3 in the air for the exclusion zone

It is observed that the annual averages of the tritium concentration in the air are below 4 Bq / m³, for the locations outside the exclusion zone and below 15 Bq / m³, for the locations inside it (the locations on the plant location).

The values of the tritium concentration in the water from the atmospheric air, determined by ICSI Rm. Vâlcea in 2020, in four locations in the vicinity of CTRF, are presented in table 3.2.1.5.

Table 3.2.1.5 Values of tritium concentration in atmospheric air water in 2020

Location	H-3 activity concentration in trial (Bq / l)
LCM	1.2 ± 0.3
PCA10	0.8 ± 0.3
CTRF	2.6 ± 0.3
DIDSR	2.0 ± 0.3
RM	130 / 01.10.2020

Following the report issued by ICSI RM Valcea (measurement report no. 130), the values of tritium concentration in bubbling water (100ml) after bubbling a volume of 144 liters of air, resulted in the concentrations presented in table 3.2.1.6. The following formula was used to obtain these results:

$$C_{air} = C_{water} * V_{water}(l) / V_{air}(mc) = C_{air} * 0.1 / 0.144.$$

Considering that the sampling was done quantitatively (sampling yield was 100%), these values represent the estimation of tritium concentrations (Figure 3.2.1.6).

Table 3.2.1.6 Estimation of tritium concentrations

Location	H-3 activity concentration in test (Bq / m3)
LCM	0.83 ± 0.21
PCA10	0.56 ± 0.21
CTRF	1.81 ± 0.21
DIDSR	1.39 ± 0.21

At the same time, the environmental radioactivity monitoring program at Cernavoda NPP aims to determine the level of contamination of wet atmospheric deposits, by taking monthly samples from five locations, as follows: SSS-03 Saligny, SSS-04 Cernavoda (Environmental Control Laboratory) - from the outside, SSS-09 DICA, SSS-17 Location U1-U2 and SSS-19 DIDSR - from the site. Figure 3.2.1.9 presents the annual averages of the tritium activity concentration from the atmospheric deposits' samples taken between 2005-2020.

Concentratia specifica medie de H-3 in depuneri atmosferice umede
 2005 - 2020

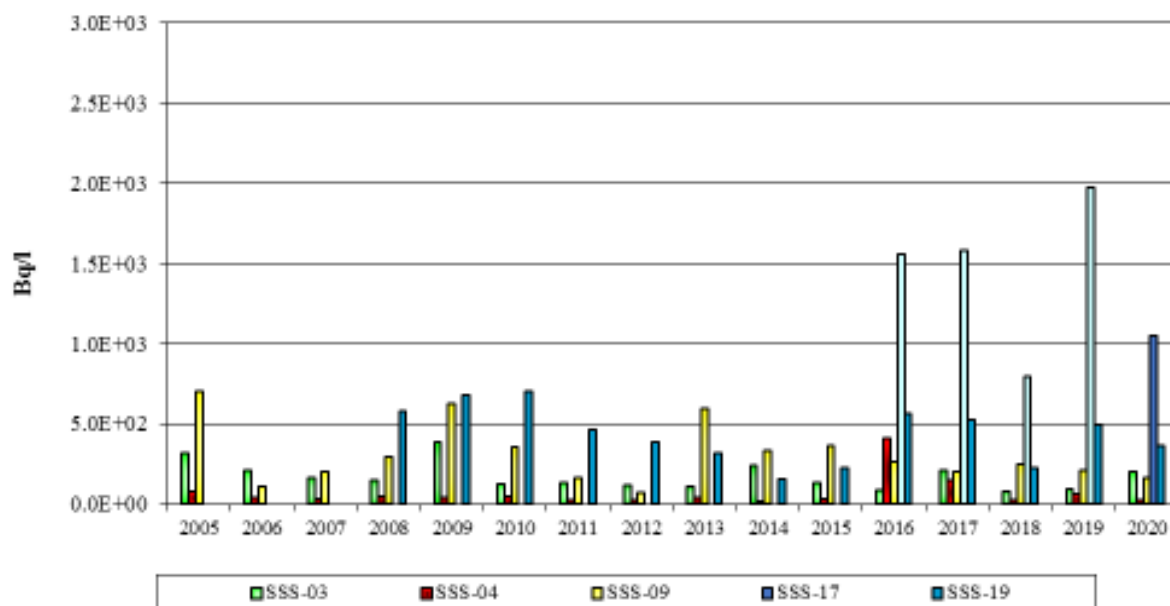

Figure 3.2.1.9 The average specific concentration of H-3 in humid atmospheric deposits for the period 2005-2020

The activity concentration of tritium in wet deposits was also determined in a sample taken by ICSI Rm. Vâlcea in 2020, from a location positioned approximately 3 km N-NW of the plant. The results are given in the measurement report no. 136 / 01.10.2020 and shows that the value of the concentration of activity in the sample of humid atmospheric deposits taken in the location of Hotel Yahoo was 1.5 ± 0.3 Bq / l. This value **confirms the low levels of tritium activity concentration in locations outside the exclusion zone of Cernavoda NPP.**

Also, during the analysis carried out by RATEN ICN Pitești in 2021, a sample of humid atmospheric deposits was taken from the location: Environmental Control Laboratory (LCM), between 16.06 - 14.07.2021. The objective of this sampling was to determine the concentration of alpha-emitting radionuclides in the humid atmospheric deposits in the vicinity of the CTRF site. The results of this monitoring are presented in Table 3.2.1.7.

Table 3.2.1.7 Alpha-emitting radionuclides in wet atmospheric deposits in the vicinity of the CTRF site

Measured parameter / Wet deposit - LCM	Result	Measurement report / issuer
Activity concentration Pu-239/240 (mBq / l)	<0.2	708 / 23.09.2021 RATEN ICN Pitesti
Activity concentration Pu-238 (mBq / l)	<0.2	
Activity concentration Am-241 (mBq / l)	<0.3	
Activity concentration U-238 (mBq / l)	<1.1	
Activity concentration U-235 (mBq / l)	<1.1	
Activity concentration U-234 (mBq / l)	1.6 ± 0.8	

Starting with 2011, Cernavoda NPP monitors the concentration of C-14 in the air, by taking

monthly samples from three locations, two of which are on the NPP site and one is in the city of Cernavoda. Figure 3.2.1.10 shows the annual average values of C-14 concentration in the air, recorded in the monitoring program.

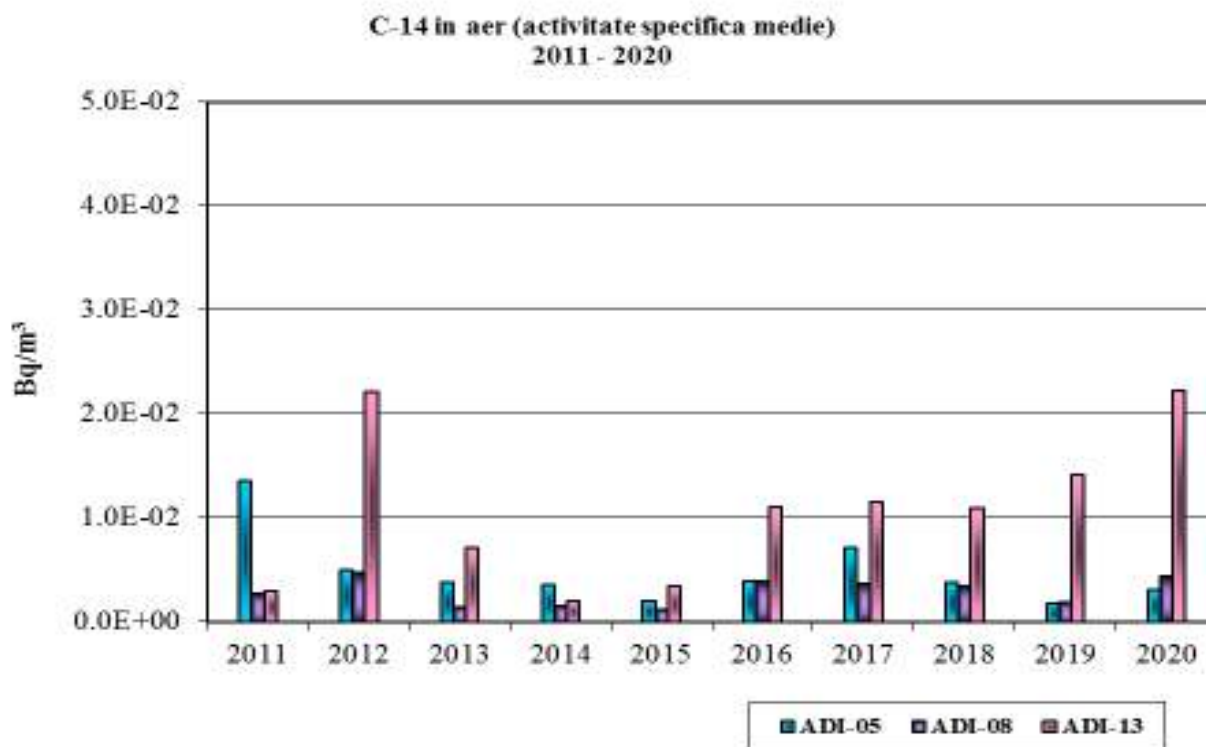

Figure 3.2.1.10 Annual average C-14 values in the air for 2011-2020

The values of the C-14 concentration in the atmospheric air, determined by ICSI Rm. Vâlcea in 2020, in four locations in the vicinity of CTRF, are presented in table 3.2.1.8.

Table 3.2.1.8 C-14 concentration in atmospheric air, determined by ICSI Rm Valcea for locations in the vicinity of CTRF

Location	C-14 activity concentration in air (Bq / gC)
LCM	0.261 ± 0.018
PCA10	0.251 ± 0.018
CTRF	0.242 ± 0.018
DIDSR	0.267 ± 0.018
RM	8 / 03.11.2020

Considering the reference values of CO₂ concentration in atmospheric air (412.5 ppm [85]), it is possible to estimate the activity concentration of C-14 in the air, corresponding to the above results. These estimates are presented in table 3.2.1.9.

Table 3.2.1.9 Estimation of C-14 concentration

Location	C-14 activity concentration in the air (Bq / m³)
LCM	0.046 ± 0.003
PCA10	0.044 ± 0.003
CTRF	0.043 ± 0.003
DIDSR	0.047 ± 0.003

It is observed that the values recorded are slightly higher than the annual averages obtained in

the monitoring program, probably due to differences in sampling and processing methods and reporting of results used in the two types of monitoring.

The concentrations indicated by ICSI Rm. Vâlcea correspond to the reference level (from the specialty literature), of the activity concentration of C-14 in the carbon involved in the atmospheric cycle (contaminated from the cosmogenic source). This **shows that the activity of the plant did not change, at a detectable level, the local concentration of C-14 in the atmospheric air, not being a permanent and significant source of C-14 contamination of the atmosphere.**

Dispersion factors for radionuclides released into the atmosphere as gaseous effluents shall be calculated based on the methodology presented in Subchapter 1.4.14, using dispersion models adapted to the characteristics of the installation and its location (theoretical dispersion factors) or based on monitoring data (empirical dispersion factors).

Regarding the values of the empirical dispersion factors of tritium, calculated based on the monitoring data from 2010 to 2020, they were presented in table 1.4.10.1. Similarly, empirical dispersion factors for C-14 can be determined in the three monitoring locations in the vicinity of the plant, where the concentration of C-14 in the air was determined (Table 3.2.1.10).

Table 3.2.1.10 Empirical dispersion factors for C-14 in the three monitoring locations in the vicinity of the plant

Location	Distance (km)	Dispersion factor C-14 (10^{-9} s/m ³)												
		2011	2012	2013	2014	2015	2016	2017	2018	2019	2020	Max.	Med.	St.dev.
ADI-13	0.5	182	1484	527	150	209	1061	971	918	1044	1997	1997	854	603
ADI-05	1.5	899	326	264	271	126	377	574	308	120	370	899	363	229
ADI-08	2.5	152	278	97	93	78	334	294	293	127	258	334	200	100

3.3 Soil / subsoil environmental factor

3.3.1 Topography

Cernavoda NPP is located on the left bank of the Danube-Black Sea Canal, in a region bordered on the west by the Danube and Câmpia Română, and on the east by Podișul Dobrogean (Dobrogea Plateau). The low plain in which the Cernavoda area falls is part of the relief unit known as Platforma Dobrogei de Sud, the confluence area between the deltaic plain in the immediate vicinity of the Danube and the western extremity of Podișul Carasu (Carasu Plateau) [8].

The location of the CTRF project is placed along the Cismelei valley (Valea Cismelei), which has a low geodeclivity that does not favor the manifestation of active geomorphological phenomena [117]. Therefore, it can be admitted that the topography of the land on which the site will be located is generally flat, the higher lands being positioned in the northeastern part of the project (related to the Cernavoda Wind Farm) and in its western part (associated between the Danube and the Danube-Black Sea Canal). The altitude of the relief where the project site is located is +16 mBSL (meters above the level of the Baltic Sea), which corresponds to the entire site of Cernavoda NPP.

3.3.2 Geology

From a geological point of view, the location of the Cernavoda NPP platform belongs to the geological, morphological, tectonic and structural unit of Dobrogea de Sud (South Dobrogea) (Figure 3.3.2.1). This unit is delimited to the north by the Capidava Ovidiu fault, to the south by the partially identified Sabla Călărași Urziceni fault, to the west by the Danube fault, and to the east by the Black Sea coast. In the perimeter of the enclosure and in the surroundings there are geological formations that belong in depth to the Jurassic and Cretaceous, but also to the Quaternary deposits that belong to the middle and lower Pleistocene [18].

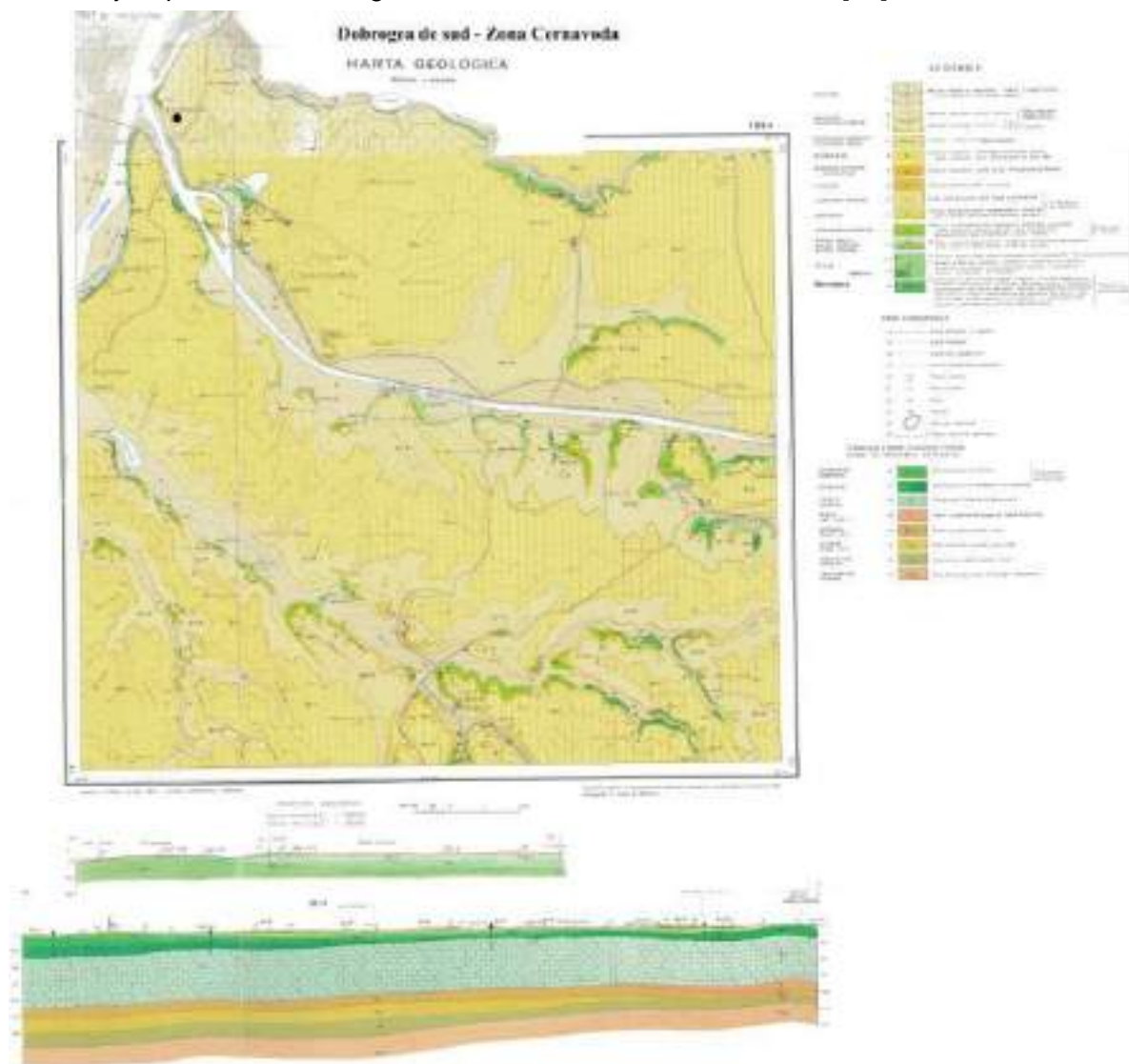

Figure. 3.3.2.1 Geological map in the area of the Cernavoda NPP platform

Shallow formations are Quaternary deposits, consisting of loessoid-clay deposits and Aptian deposits, made up of clays and dense sands, arranged over the bedrock, represented by Barremian limestone.

The nuclear units in operation of the Cernavoda NPP (U1 and U2), located within the development limits of the Cretaceous age formations, have at the foundation quota of the nuclear buildings, Barremian limestone.

Studies have shown that the geological structure of the site area provides good conditions for the stability and foundation of the plant's buildings and therefore does not raise issues related to nuclear safety.

For the foundation of the structures belonging to Cernavoda NPP, the sedimentary formations of Jurassic age (Bathonian, Callovian, Oxfordian, Kimmeridgian) were conventionally considered as the bedrock. These formations are transgressively arranged over the weakly metamorphosed corrugated foundation of the green shales and consist of hard limestone alternating with siliceous limestone, sandstone limestone.

The covering formations are rocks of sedimentary origin belonging to the Cretaceous (Valanginian, Barremian, Aptian) and Quaternary. The site of the Cernavoda NPP is located within the development limits of the Cretaceous age formations, it presents at the foundation level of the nuclear buildings, Barremian limestone and Valanginian marls. Valanginian-Hauterivian (V) - is arranged over the Jurassic and was found on the entire surface of the researched enclosure. Between the elevations of -138 mdMB and -75 mdMB, it consists of an alternation of limestone, marly limestone and marly clays, and at the bottom there is a conglomerate level with a thickness between 4 m and 4.50 m. Over the horizon of the lower limestones there is a clayey marly horizon with limits approximately between elevations: +70.53 m (lowest elevation) and +1 ÷ 1.29 m (highest elevation).

Barremian (B) - consists of petrographically varied Cernavoda limestone, which has divided them into two layers, B1 and B2 [18].

B1- the topsoil consists of white, hard, cracked limestones; white-yellow limestone, porous, conchiferous limestone; clayey-sandy limestones yellowish, oolitic, chalky white limestones, friable, arranged in almost horizontal layers with a thickness of 0.20 + 1.00 m, with a slight arch towards the center of the quarry. The thickness of layer B1 is between 11 m and 26 m.

B2- the layer made of yellow-brown limestone, with intercalated porous white limestone, forming a transition line between marls and B1 limestones. This layer appears inhomogeneous in both thickness and constitution, with an average of 30-40% limestone and 60-70% clayey limestone, yellow, compact calcareous clays and compact sands.

The thickness of layer B2 is between 6 m and 10 m. The alternations of calcareous clay and porous limestone in layer B2 are also found in the deep excavations made at about 1.5 km distance for the Danube-Black Sea canal lock. This shows that these are alternating layers and not boulders trapped in the limestone mass. The entire limestone complex is riddled with cracks and fissures ranging in size from millimeters to tens of centimeters, filled with clay or hollow. Below a certain level (on average +7.50 and +8.0 mdMB) they are filled with water. No karstic holes have been found in the outcrops of the quarry and in the drilled holes, but the possibility of their existence should not be completely ruled out.

Aptian - appears in the form of patches over limestone and consists of gravel and clay. Aptian marine deposits appear as a lentilform intercalation in the continental-lacustrine series of the Dobrogea Aptian.

Quaternary - is represented by loess on hills and mallow clays presumably in meadow areas, covering Aptian limestones and clays. The Quaternary deposits cover the limestones with 4 ÷ 5 m, and towards the Carasu valley they reach thicknesses exceeding 35 ÷ 40 m (covering the old bed of the Carasu valley, eroded during the geological history) [18].

For the supply of drinking water to Cernavoda NPP, before 2006, 3 drillings were made at a maximum depth of 700 m Two of the boreholes were drilled within Cernavoda NPP, and the third was drilled on the outskirts of Cernavoda. Determinations made through the three boreholes showed the following deep geological structure [33]:

1. The unit of the Quaternary deposits is between 0 and 25 m deep and contains in the first 9 m deposits formed of Berriasian-Valanginian limestone next to Aptian gravels, after which the soft and silty yellowish clays complete the layer up to 25 m. This largely clayey layer, appeared by sedimentation in lake basins, most likely related to the Danube.
2. The unit of the continental deposits is developed within the layer between 25 and 32 m depth. They belong to the Middle + Late Aptian period, and are made up of quartz pebbles and sands, with thin intercalations of kaolinitic clays. This is a detritiated lithostratigraphic structure with

continental origins, which is widespread in the northern part of the South Dobrogea Plateau (Podișul Dobrogei de Sud).

3. The geological unit of the carbonate complex I of late Berriasian - Early Valanginian age appears in the layer between 32 and 50 m deep. Porparitic limestones, calcareous or quartz sandstones, frequently recrystallized bioclastic limestones, calcarenites, oolites, marly limestones and marls contribute to the lithological composition of this unit.
4. The geological unit represented by the marl complex and the polychrome clays of the Purbeckian facies of the early-middle Berriasian age takes place in a layer between 50 and 100 m deep. This unit is characterized by the alternation of marls and violet / green clays, calcarenites, oolites, fine clayey sandstones, marly limestones and calcareous sandstones. It was formed on the border between Jurassic and Cretaceous, the predominant phenomenon being that of sedimentation in lagoon and continental-lake conditions.
5. The geological unit represented by the Carbonatic II complex of early Berriasian age is found in the layer between 100 and 161 m depth. It mainly includes detrital limestones, calcareous sandstones, bioclastic limestones and oolitic limestones. It is also worth noting the presence of a secondary level of carbonate which is located between the clay complex and the polychrome marls, as well as the presence of an evaporite complex in its lower part.
6. The geological unit of the late Tithonian evaporite complex is found between the depths of 161 and 363 m, gypsum and massive anhydrides, gypsiferous clays and marls and micritic limestones with anhydrides are present.
7. The geological unit of the Kimmeridgian-Early Tithonian dolomitic complex of early-middle evaporite is between 363 and 700 m deep. Characteristic for this complex is the thick succession of dolomitized limestones and karstified at different levels. Inside the mass of dolomites there are gaps caused by the dissolution generated by the pressure of the carbonate rock. These gaps form a system of branched channels that can be extended to a regional scale. Within the dolomitic mass there are marly intercalations and marly limestones. This complex is the main objective of exploring groundwater in the studied area.

3.3.3 Soil

The pedological cover of the Cernavoda NPP area includes soils developed in the meadow area as well as soils developed on loessoid deposits. Thus, young and partially developed alluvial soils are present on the right bank of the Danube. The chemical composition and particle size composition of these soils reveal a high degree of inhomogeneity, these soils having a differentiated profile. These soils with a high calcium carbonate content are characterized by a pH value around 8, which gives them a moderate basic character. In terms of texture, the presence of all types from clayey to sandy is noticeable.

White soils are present in regions characterized by the presence of loess or loess deposits in the substrate. They occur mainly in the north of the Carasu Valley and between Cernavoda and Medgidia. In the case of this type of soil, the low humidity makes processes such as leaching and alteration less intense. Thus, the alkaline reaction and poor leaching led to the formation of humic acids and the presence of calcium cations. The pH of the soils is between 8 and 8.3, while their profile has a low differentiation characterized by a dark brown-yellow upper horizon with a small and very small particle size structure. Humus and nutrients are low. These soils are characterized by a high moisture deficit due to low precipitations and intense evaporation [18].

3.3.4 Land condition and use

In the vicinity of Cernavoda NPP, land use is predominantly agricultural being influenced by the protection zone of the plant which extends up to 30 km around it (Figure 3.3.4.1).

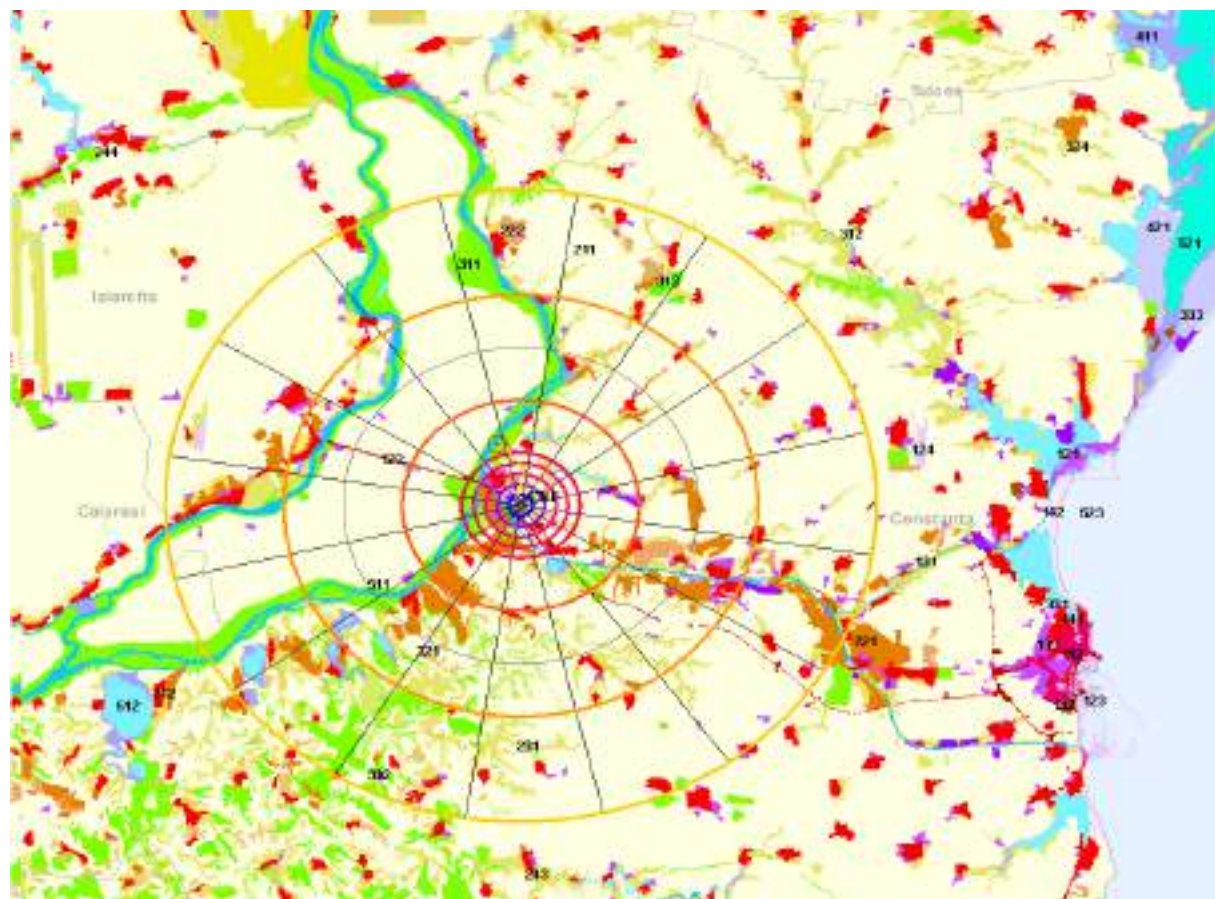

Figure 3.3.4.1 Map of land use in the area of the Cernavoda NPP platform

According to figure 3.3.4.2, in the area delimited around Cernavoda NPP, the largest areas are occupied by arable land with a percentage of 73.6% of the total. These are areas on the surface of which irrigation systems operate for the most part. Cereals (wheat, corn) are cultivated mainly on arable land, but also fodder plants or sunflower. Long distance, are the pastures that occupy about 7.66% of the territory, followed by forests with a percentage of 6.21%. Forests and shrubs (0.19%) cover areas of hills with a steeper slope in which the intervention of human activity was

less intense, thus maintaining a stable ecological balance. Forests found within a radius of 30 km from Cernavoda NPP are grouped into 2 categories based on their role [8]

- forests to produce and protect wood in order to obtain valuable assortments;
- forests which are to be protected and which cannot be used for timber harvesting because they are subject to a conservation regime.

It is considered that the operational activity within the Cernavoda NPP does not affect the forest areas [8].

The built-up areas have a share of 4.32%, these being mainly discontinuous urban structures or industrial and commercial units. The viticultural areas, which account for a percentage of 3.71%, are found mainly in the vicinity of Cernavoda, Cochirleni, Rasova, Aliman, Medgidia, Mircea-Voda and Tortomanu [8]. Areas occupied by rivers account for 2.36% of the total, while orchards occupy 0.88%. The Medgidia and Mircea Vodă areas east of Cernavoda are among the most compact orchards in the studied region.

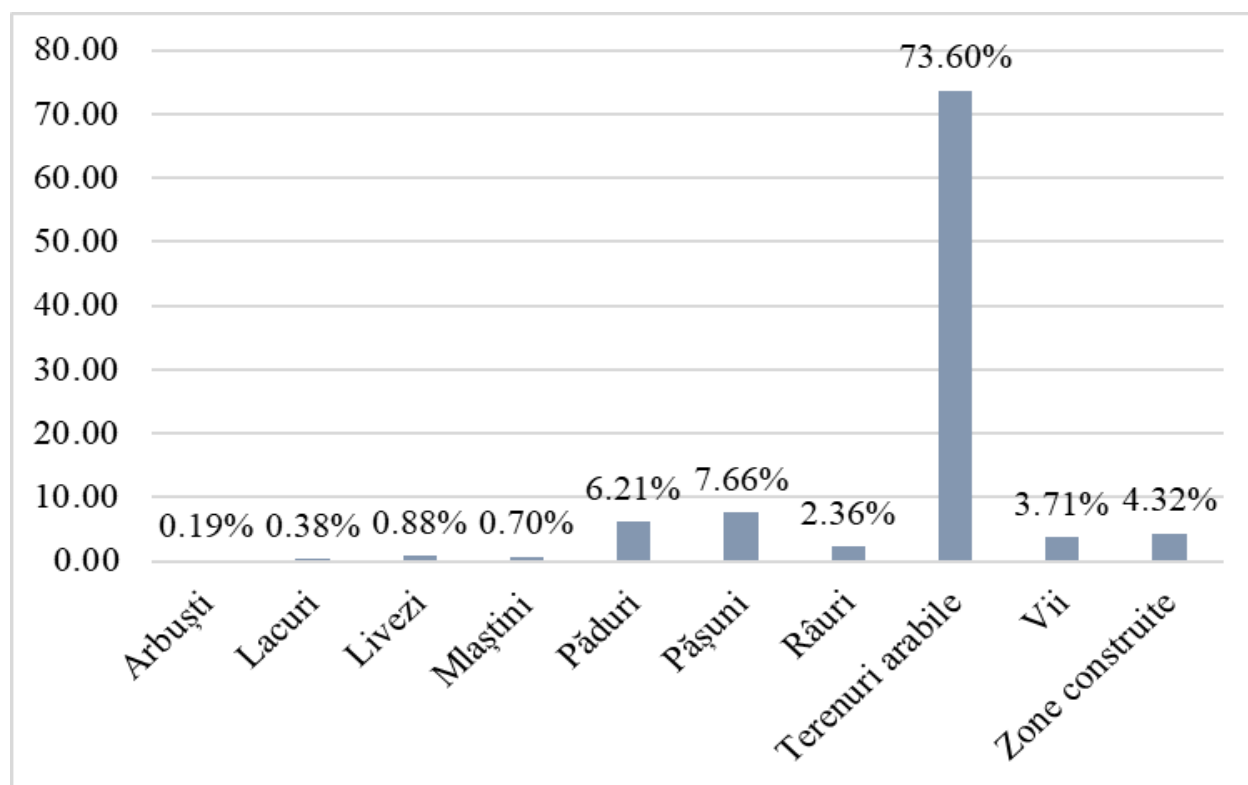

Figure 3.3.4.2 The share of different types of land use within a radius of 30 km around Cernavoda NPP

Source: Corine Land Cover, 2018

(Left to right: Shrubs, Lakes, Orchards, Swamps, Forests, Pastures, Rivers, Arable lands, Vineyards, Built areas)

3.4 Biodiversity

In the chapter on the biodiversity within the potentially affected perimeter, which implicitly includes also the habitats on the areas to be occupied by the project and its surroundings, the areas of conservation interest were described and illustrated on an appropriate map within a radius of 30 km around the site. This report described the populations of the species and the characteristics of the habitats that may be affected by the project and defined any protected species or species designated to be protected.

Habitats

Habitat types and areas in the area of influence are shown in Table 3.4.1, according to the Corine Land Cover classification, 2018. These habitats will be discussed in detail, including habitats classified according to EUNIS12 in the following paragraphs (habitat mapping is shown in Figure 3.4 .1).

Table 3.4.1 Habitat Types (Corine Land Cover, 2018)

CLC code	Name	Area (Ha)	% of CLC without N2K	% of the total 30 km area CTRF
112	Discontinuous urban area	7319.434	3.22	2.59
121	Industrial or commercial units	2595,905	1.14	0.92
122	Road and rail networks and associated land	888,273	0.39	0.31
123	Port areas	162,658	0.07	0.06
124	Airport	208,349	0.09	0.07
131	Mineral extraction sites	308,671	0.14	0.11
132	Waste pits/landfills	26,436	0.01	0.01
141	Green urban areas	287,085	0.13	0.10
142	Sports and relaxation facilities	29,653	0.01	0.01
211	Irrigated arable land	181887.07	80.11	64.33
213	Rice fields	1583.728	0.70	0.56
221	Vineyards	10090.331	4.44	3.57
222	Fruit trees and berry plantations	1969.406	0.87	0.70
231	Pastures	9986.294	4.40	3.53
242	Complex cultivation models	2605,492	1.15	0.92
243	Land mainly occupied by agriculture, with significant areas of natural vegetation	1543,528	0.68	0.55
311	Hardwood forests	2239.347	0.99	0.79
321	Natural meadows	1146,906	0.51	0.41
324	Forest / shrub transition areas	262,658	0.12	0.09
411	Inner swamps	508,704	0.22	0.18
511	Streams	1038,653	0.46	0.37
512	Water bodies	371,165	0.16	0.13
TOTAL		227059.746		19.69

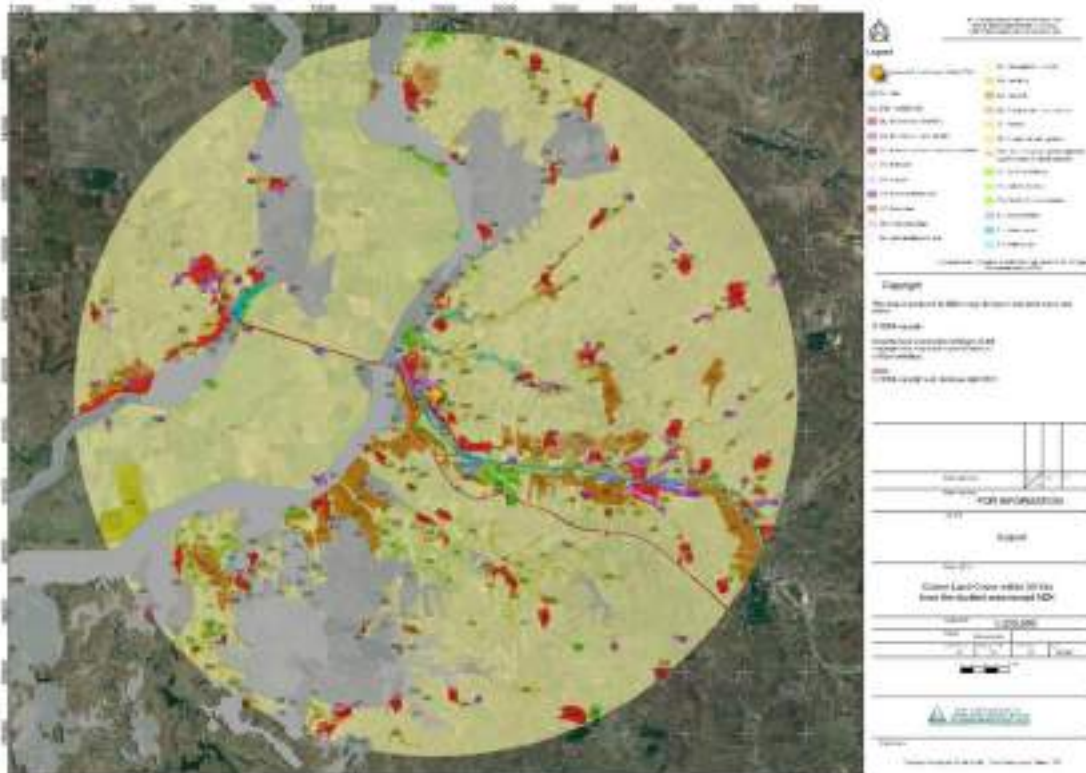

Figure 3.4.1 CLC map within a radius of 30 km from the CTRF project location

Protected areas

In the 30 km area of influence (ZdI), there are 14 areas of conservation interest for the long-term protection of biodiversity (Figure 3.4.1).

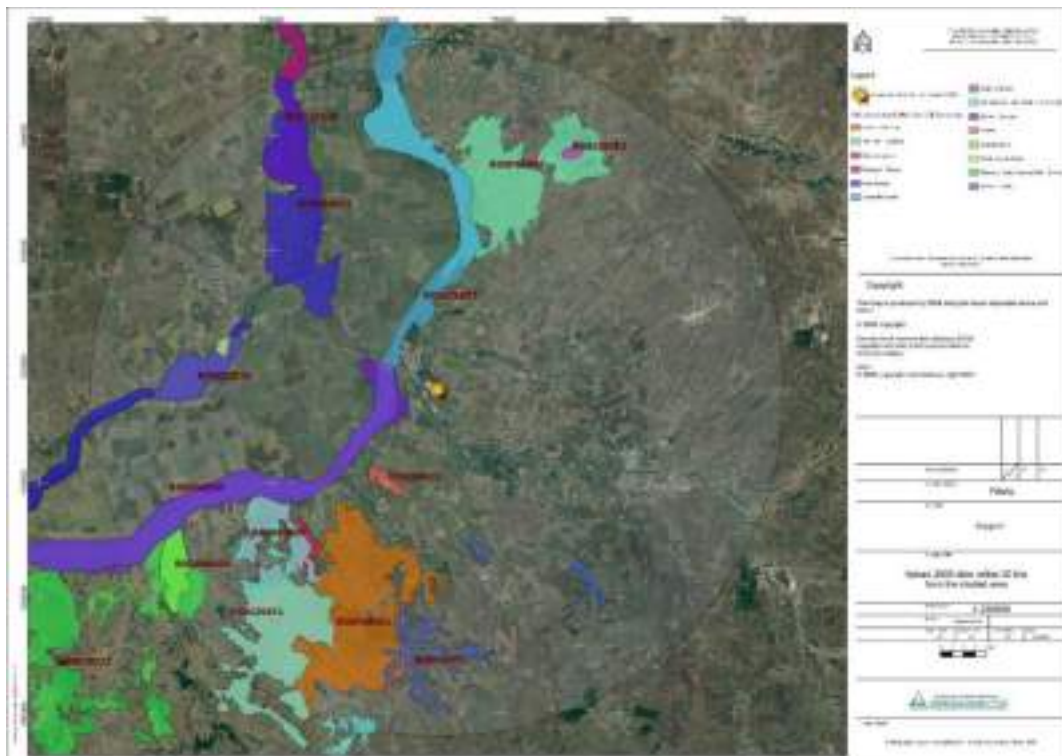

Figure 3.4.2 Map of Natura 2000 sites located within a radius of 30 km from the CTRF project location

Of the 14 sites located within a radius of 30 km, eight are Sites of Community Interest (SCI) and six Areas of Special Protection of Avifauna (SPA). Two of the sites (ROSPA0039 Dunare - Ostroave and ROSCI0022 Canaralele Dunarii are less than 5 km from the site. Seven sites are within a radius of 10-15 km, two between 15 and 20 km and three sites between 20 and 30 km from the site (Figure 3.4. 3, Table 3.4.2).

Natura 2000 sites are "the most suitable areas", both in number and area, for the protection of bird species listed in Annex I of the Birds Directive, as well as migratory species. In the case of the Habitats Directive, designated sites ensure that the types of natural habitats listed in Annex I and the habitats of the species listed in Annex II shall be maintained or, where appropriate, restored to an appropriate conservation status in their natural range.

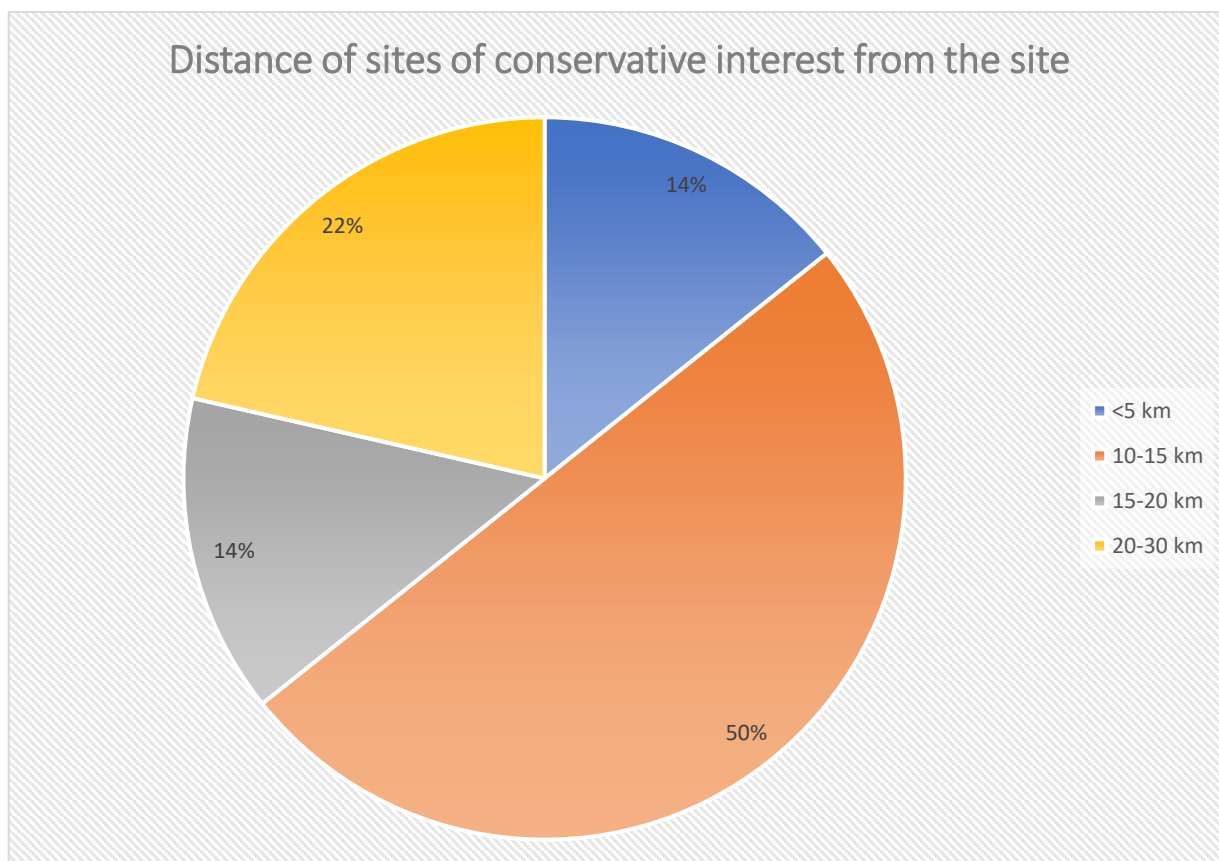

Figure 3.4.3 Cyclogram on the distribution of sites of conservation interest to the site

Table 3.4.2. Sites located within a 30 km radius of the CTRF project location

Crt. no.	Site code	Normative act of establishment	Distance from the project location	Site name
1	ROSPA0039	HG 1284/2007	<2 km	Dunare - Ostroave
2	ROSCI0022	OM 1964/2007	<3 km	Canaralele Dunarii
3	ROSCI0053	OM 1964/2007	10 km	Allah Bair Hill
4	ROSCI0412	OM 46/2016	10 km	Ivrinezu
5	ROSPA0002	HG 1284/2007	10 km	Allah Bair - Capidava
6	ROSPA0012	HG 1284/2007	10 km	Borcea Branch
7	ROSPA0001	HG 1284/2007	12 km	Aliman - Adamclisi
8	ROSCI0353	OM 2387/2011	13 km	Pestera - Deleni
9	ROSPA0007	HG 1284/2007	13.5 km	Balta Vederoasa

10	ROSCI0071	OM 1964/2007	17 km	Dumbraveni - Urluia Valley-Vederoasa Lake (Dumbraveni - Urluia Valley - Vederoasa Lake)
11	ROSCI0319	OM 2387/2011	17.5 km	Fetesti Swamp
12	ROSCI0278	OM 2387/2011	20 km	Bordusani - Borcea
13	ROSCI0172	OM 1964/2007	25 km	Canaraua Fetii Forest and Valley - Iortmac
14	ROSPA0054	HG 1284/2007	25 km	Dunareni Lake

The following is a brief description of the Natura 2000 sites in the study area in order of distance from the project location [74-80].

1. ROSPA0039 Dunare – Ostroave

Avifauna Special Protection Area - 16224 ha

The site stretches along the Danube and includes 9 islands. The hydrological aspects of the islands are dominated by the hydrological regime of the Danube. The dominant habitats within the perimeter of this protected area are wetlands and meadow forests. The site is home to many protected bird species as follows: number of species in Annex 1 of the Birds Directive - 39, other migratory species in the annexes to the Bonn Convention - 36. Of these, five species are globally endangered.

The site is important for the nesting populations of the following species: *Coracias garrulus*, *Falco vespertinus*, *Aythya nyroca*, *Platalea leucorodia*, *Egretta garzetta*, *Nycticorax nycticorax*, *Plegadis falcinellus*, *Phalacrocorax pygmaeus*, *Ardea purpurea*, *Haliaeetus albicilla*, *Ardeola ralloides*, *Lanius minor*, *Caprimulgus europaeus* and *Milvus migrans*. The site is important during the migration period for the species: *Plegadis falcinellus*, *Phalacrocorax pygmaeus*, *Aythya nyroca*, *Sterna hirundo*, *Tringa glareola*, *Himantopus himantopus* and *Ciconia ciconia*. The site is important for wintering for the following species: *Branta ruficollis* and *Phalacrocorax pygmaeus*.

2. ROSCI0022 Canaralele Dunării

Site of Community Importance - 25943 ha

The site has a wide variety of protected habitats, from hygrophilous to xerophilous, including meadows, bushes, forests. Among these habitats, the most representative, both the area occupied in the site (30%) and at national level (11%) is the habitat of *Salix alba* and *Populus alba gallerie* (*Salix alba* and *Populus alba gallerie*). It also includes important areas of trees excluded, since the formation, from forestry interventions, which can be considered as virgin forests (located mainly on islands), as well as tree areas with secular trees (especially poplars) on areas of tens of hectares (eg Ostrovul Turcesc).

3. ROSCI0053 „Dealul Allah Bair” (Allah Bair Hill)

Site of Community Importance - 193.50 ha

The site is particularly important from a floristic point of view; it houses endemic species, rare and endangered for the Romanian flora. Site of Community Importance designated for the conservation of priority habitat 62C0 * Ponto-Sarmatic steppes and populations of three plant species 2236 *Campanula romanica*, 2125 *Potentilla emilii-popii* and 2093 *Pulsatilla grandis*. The importance of the location has been mentioned in the literature since 1929 and is home to about 30 rare petrophilic species of Pontic, Balkan, Pontic-Balkan and Pontic-Mediterranean origin.

The conservation status of the calcareous steppe vegetation is relatively good, with rare and endemic species of flora being in a good state of conservation (eg *Agropyron cristatum* ssp. *Brandzae*, *Campanula romanica*).

The site also contains the Allah Bair Hill Reserve, which was initially placed under protection by Decision no. 31/1980 of the Constanța County People's Council. It was declared as a natural area of national interest by Law 5/2000 - on the national territory landscaping plan - Section III protected area of national interest (protected area code 2367) with an area of 10 ha.

4. ROSCI0412 Ivrinezu

Site of Community Importance - 411.1 ha

It is an important site for the conservation of *Mesocricetus newtoni* as well as *Testudo graeca*, *Elaphe quatuorlineata*, *Spermophilus citellus*, and their habitat, in an area that has been devoid of protected areas for these species, whose populations have been identified within the site.

5. ROSPA0002 Allah Bair – Capidava

Avifauna Special Protection Area - 11645.10 ha

The site is important for the species of birds of European conservation interest characteristic of the agricultural and steppe areas of Dobrogea: *Anthus campestris*, *Burhinus oedicephalus*, *Calandrella brachydactyla*, *Emberiza hortulana*, *Melanocorypha calandra*. The site is also very important for waterfowl species such as: *Tadorna ferruginea*, *Phalacrocorax pygmeus*, *Sterna hirundo*, *Chlidonias hybridus*, *Chlidonias niger*, *Larus minutus*, *Alcedo atthis*. During the migration, large numbers are recorded for: *Aquila pomarina*, *Ciconia ciconia*, *Ciconia nigra*, *Circus aeruginosus*, *Buteo buteo*.

6. ROSPA0012 Borcea branch

Avifauna Special Protection Area - 13096,80 ha

The site is important for nesting populations of the following species: *Aytha nyroca*, *Milvus migrans*, *Haliaeetus albicilla*, *Falco vespertinus* and *Coracias garrulus*; colonies of *Ardeidae* and *Threskiornithidae*. The site is important during the migration for the species: *Ciconia alba* and *Ciconia nigra*, *Plegadis falcinellus*, *Platalea leucorodia*, *Sterna hirundo*, geese and ducks. During the winter, both the wetlands and the agricultural areas around the site are particularly important habitats for the feeding and resting of *Branta ruficollis* flocks.

7. ROSPA0001 Aliman - Adamclisi

Avifauna Special Protection Area - 19467.80 ha

This site is home to important flocks of protected bird species. The site is important for nesting populations of species characteristic of agricultural and steppe areas in southeastern Romania such as: *Anthus campestris*, *Calandrella brachydactyla*, *Melanocorypha calandra*, *Coracias garrulus*, *Burhinus oedicephalus* and *Falco vespertinus*. It is an important nesting and feeding area for *Buteo rufinus*. It is also one of the areas where the presence of the Imperial Eagle and the Saker falcon is recorded.

8. ROSCI0353 Pestera - Deleni

Site of Community Importance - 2549.3 ha

Habitat of pasture characteristic of the species of conservative interest - *Mesocricetus newtoni* and *Spermophilus citellus*. The site is mostly covered by pastures (80.1%), agricultural crops (16.5%) and natural pastures. The site has been designated for the conservation of species associated with natural and semi-natural open environments such as meadows, pastures and cultivated land. Thus, the structural and functional relationships that create and maintain the integrity of the protected natural area are those related to cultivation practices practiced so far in a traditional, non-intensive way that have allowed species of conservation interest (ground squirrel and Dobrudja hamster) to colonize this area and to remain present with important populations.

9. ROSPA0007 Vederoasa Lake

Avifauna Special Protection Area - 2144 ha

This site hosts important flocks of protected bird species, as follows: a) number of species in Annex 1 of the Birds Directive: 34; b) number of other migratory species listed in the annexes to the Convention on Migratory Species (Bonn): 70 c) number of globally endangered species: 4 The site is important for nesting populations of the following species: *Tadorna ferruginea*, *Nycticorax nycticorax*, *Ardeola ralloides*, *Egretta garzetta*. The site is important during the migration period for pond species (especially pelicans and geese). The site is important for wintering for ducks and geese. During the migration period, the site is home to more than 20,000 waterfowl

10. ROSCI0071 Dumbraveni - Valea Urluia - Lacul Vederoasa (Dumbraveni - Urluia Valley - Vederoasa Lake)

Site of Community Importance - 17971 ha

The site includes several scientific and natural reserves. It is home to at least eight protected habitat types at European level, of which three are a priority. The site includes protected plant

species at European level - Annex II of the Habitats Directive: *Centaurea jankae*, *Himantoglossum caprinum*, *Potentilla emilii-popii*, *Echium russicum*. It hosts a rich avifauna, being identified over 100 species of birds. Some species of birds have important numbers, such as predators, larks, woodpeckers, Caprimulgus and the like, which is why it has been designated as a Special Protection Area for Avifauna.

11. ROSCI0319 Mlastina de la Fetesti (Fetesti Swamp)

Site of Community Importance - 2020 ha

The site was designated in the lower Danube area, in a meadow area that was completely flooded in the past. The defense works that involved the construction of a dam have limited the floodability of the area, which is manifested only in isolation, by infiltration due to the increase of groundwater levels that remain in connection with the riverbed. According to the Standard Natura2000 Site Design Form ROSCI0319 Mlaștina Fetești, the presence of habitat of conservative interest is mentioned: 92A0 *Zăvoaie cu Salix alba și Populus alba*. The site was also designated for the conservation of otter populations - *Lutra lutra*, European pond turtle - *Emys orbicularis*, Danube crested newt - *Triturus dobrogicus* and The European fire-bellied toad- *Bombina bombina*. These are species of fauna characteristic of wetlands in the area.

12. ROSCI0278 Bordusani - Borcea

Site of Community Importance - 5847.5 ha

The site contains the following habitat classes: Continental freshwater (stagnant, flowing) = 35%, deciduous forests = 30%, Monoculture forests (poplars or exotic trees) = 25%, Wet semi-natural meadows = 8%, other lands = 2%. The site functions as an ecological corridor along the Borcea arm, connecting the sites along the Danube with the Coridorul Ialomitei site. The site is also important for forest habitats (92A0 *Zăvoaie cu Salix alba și Populus alba*.) and aquatic habitats, as well as for amphibian and reptile populations.

13. ROSCI0172 Padurea si Valea Canaraua Fetii - Iortmac (Canaraua Fetii Forest and Valley – Iortmac)

Site of Community Importance - 13631 ha

The remarkable value of the site is given by the presence of rare flora species, internationally protected ornithofauna species, mammalian sub-Mediterranean, Balkan and Pontic species, reptiles and invertebrate species.

The reserve presents floristic species characteristic of the Ponto-Caspian region and the Macaronesian-Mediterranean region, being reported approximately 1000 species of superior plants, representing 27% of the Romanian flora. In terms of fauna, the protected natural area comprises many rare animal species of sub-Mediterranean, Balkan or Pontic origin. The reserve is particularly important due to the multitude of habitats and rare, protected species that it has, many of which are migratory bird species that land here due to the climatic conditions. The characteristic habitats of the reserve are thermophilic forests with *Quercus pedunculiflora* and *Carpinus orientalis*, calcareous steppe areas, caves and swampy areas.

14. ROSPA0054 Lacul Dunăreni (Dunăreni Lake)

Avifauna Special Protection Area - 1261.2 ha

Within the perimeter of the site is a mosaic of aquatic and agricultural habitats particularly important for the nesting, migration and wintering of many species of waterfowl of conservative interest. The site is home to over 100 species of birds, 35 of which are nationally and internationally protected. The Danube Lake site offers nesting conditions for birds such as *Ixobrychus minutus*, *Tadorna ferruginea* ruddy shelduck, *Aythya nyroca* ferruginous duck, *Ardea purpurea* purple heron, *Ardeola ralloides* Squacco heron, *Glareola pratincola* Collared pratincole. During the passage, the area is important as a feeding and resting place for the populations of the species: Pygmy Cormorant *Phalacrocorax pygmeus*, Eurasian spoonbill *Platalea leucorodea*, Ferruginous Duck *Aythya nyroca*, White stork *Ciconia ciconia*, Ruff *Philomachus hirnax*, Common tern *Sterna hirundo* etc. During the migration period, the site is home to over 20,000 waterfowl. In winter, when it is not frozen, Dunăreni Lake provides food and resting places for species such as Pygmy Cormorant *Phalacrocorax pygmeus*, Red-breasted Goose *Branta ruficollis* and the Greater white-fronted goose *Anser albifrons*.

On the surface of the sites of the areas of interest for nature protection, in the Area of Influence of the project there are, according to the data from the management plans of the protected areas and from the Natura 2000 forms, 17 natural habitats of community interest (Table 3.4.3), from Annex I of the Habitats Directive. The largest diversity of habitats of conservative interest is found in the perimeter ROSCI0022 Canaralele Dunării (15 habitats) and the smallest is recorded in ROSCI0053 Dealul Allah Bair and ROSCI0319 Mlastina Fetești [74-80, 48, 54, 66, 68, 69].

Table 3.4.3. Presence of existing habitats in areas of interest for nature protection

Protected area Habitat type	Bordușani - Borcea	Canaralele Dunării	Allah Bair Hill	Dumbraveni- Urtiuia Valley - Vederoasa Lake	Fetești Swamp	Canaraua Fetiți Forest and Valley - Iortmac
	* Ponto-Sarmatic steppe	X	X	X	X	
* Ponto-Sarmatic deciduous bushes		X		X		X
* Ponto-Sarmatic forest vegetation with downy oak / eastern white oak forests		X		X		X
Strong oligomesotrophic waters with benthic vegetation with <i>Chara</i> spp.		X				
Oligotrophic to mesotrophic standing waters with vegetation of <i>Littorelletea uniflorae</i> and / or <i>Isoëto-Nanojuncetea</i>		X				
Plain-level watercourses with mountainous vegetation with <i>Ranunculion fluitantis</i> and <i>Callitricho-Batrachion</i> vegetation						X
Low altitude pastures (<i>Alopecurus pratensis</i> , <i>Sanguisorba officinalis</i>)		X				
Galleries of <i>Salix alba</i> and <i>Populus alba</i>	X	X			X	
Southern riparian galleries and shrubs (<i>Nerio-Tamaricetea</i> and <i>Securinegion tinctoriae</i>)		X				
Natural eutrophic lakes with <i>Magnopotamion</i> or <i>Hydrocharition</i> vegetation		X		X		
Natural dystrophic lakes and ponds	X					
Edges of high hydrophilic grasses specific to plains or mountain to alpine level		X		X		X
Mixed riparian forests of <i>Quercus robur</i> , <i>Ulmus laevis</i> and <i>Ulmus minor</i> , <i>Fraxinus excelsior</i> or <i>Fraxinus angustifolia</i> , along the great rivers (<i>Ulmenion minoris</i>)		X		X		
Pannonian-Balkan forests of Turkey oak - sessile oak		X		X		X
Euro-Siberian steppe forests with <i>Quercus</i> spp.		X		X		X
Flooding alluvial meadows, of <i>Cnidion dubii</i>		X				
Rivers with muddy shores with vegetation of <i>Chenopodion rubri p.p.</i> and <i>Bidention p.p.</i>	X	X				

Of the 17 habitats of Community conservation interest present in the Sites of Community Importance in the study area, three are habitats of priority conservation interest:

- 91AA * Ponto-Sarmatic forest vegetation with downy oak / Eastern white oak forests, found in the following sites: ROSCI0022 Canaralele Dunării , ROSCI0071 Dumbrăveni-Valea Urluia-Lacul Vederosa and ROSCI 0172 Pădurea și Valea Canaraua Fetii-Iortmac , and ROSCI0278 Bordușani – Borcea;
- 62C0 * Ponto-Sarmatic steppes, found in 5 of the sites: ROSCI0022 Canaralele Dunării , ROSCI0053 Dealul Allah Bair, ROSCI0071 Dumbrăveni-Valea Urluia-Lacul Vederosa, ROSCI 0172 Pădurea și Valea Canaraua Fetii-Iortmac and ROSCI0278 Bordușani – Borcea;
- 40C0 * Ponto-Sarmatic deciduous bushes / Ponto-Sarmatic deciduous broadleaf bushes that are distributed on the surface of the sites: ROSCI0022 Canaralele Dunării , ROSCI0071 Dumbrăveni-Valea Urluia - Lacul Vederosa and ROSCI 0172 Pădurea și Valea Canaraua Fetii - Iortmac;

Habitats of priority conservation interest are natural habitats threatened with extinction, and whose conservation has become a major responsibility, given the percentage of their natural range.

91AA * Ponto-Sarmatic forest vegetation with downy oak / Eastern white oak forests

Extrazonal forests dominated by downy oak, with sub-Mediterranean flora, occupying warmer enclaves within the subcontinental areas of *Quercion frainetto* and *Carpinion illyricum*. Forests of *Quercus pubescens* and *Q. virgiliana*. The oaks are accompanied by *Carpinus orientalis*, *Fraxinus ornus*, *Acer campestre* or *Tilia tomentosa* and sub-Mediterranean floristic elements. Thermophilic sub-Mediterranean forests of *Quercus pubescens* and *Q. virgiliana* in the southern Dinaric Mountains, the Balkan mountain range and neighboring regions, including southeastern and southern Romania. In Romania, this type of habitat is found in 24 Natura 2000 areas, occupying a total area estimated at 23408 ha. This type of habitat is found only in Romania, Bulgaria and Italy. The characteristic species are *Quercus pubescens* and *Cotinus coggygria*.

62C0 * Ponto-sarmatic steppes

The habitat includes deciduous shrubs, characterized by the presence of ponto-Sarmatic species *Caragana frutex*, *Paliurus spinachristi*, jasmine (*Jasminum fruticans*), with numerous sub-Mediterranean, Pontic and Balkan floristic elements, phytocenoses with affinities for areas rich in calcareous salts, adapted to an arid climate, located at the edge of the forest-steppe and the area of the oak forest. In Romania, this type of habitat is found in 38 Natura 2000 areas, occupying an estimated total area of **4220 ha**. This type of habitat is found only in Romania and Bulgaria.

The characteristic species are: *Paliurus spina-christi*, *Ligustrum vulgare*, *Cornus mas*, *Asphodeline lutea*, *Paliurus spina-christi*, *Jasminum fruticans*, *Rhamnus cathartica*, *Rhamnus tinctoria*.

40C0 * Ponto-Sarmatic deciduous bushes / Ponto-Sarmatic deciduous broadleaf bushes

The habitat includes deciduous shrubs, characterized by the presence of ponto-Sarmatic species *Caragana frutex*, *Paliurus spinachristi*, jasmine (*Jasminum fruticans*), with numerous sub-Mediterranean, Pontic and Balkan floristic elements, phytocenoses with affinities for areas rich in calcareous salts, an arid climate located at the edge of the forest-steppe and the area of the oak forest. In Romania, this type of habitat is found in 38 Natura 2000 areas, occupying an estimated total area of **4220 ha**. The characteristic species are: *Paliurus spina-christi*, *Ligustrum vulgare*, *Cornus mas*, *Asphodeline lutea*, *Paliurus spina-christi*, *Jasminum fruticans*, *Rhamnus cathartica*, *Rhamnus tinctoria*. This type of habitat is found only in Romania and Bulgaria.

Plants

Eight species of plants of community conservation interest are reported in the Zdl of the project (ANNEX 5) [66, 67, 69, 72, 81, 82]. In the case of the species 2093 *Pulsatilla grandis* historically

reported in the area and found in the standard site map ROSCI0053 Allah Bair Hill, the presence is uncertain in the study area [44].

2236 *Campanula romanica* - Bellflower, Habitats Directive - Annexes II, IV, Berne Convention - Annex I, GEO 57/2007 - Annex 3, Law 49/2011

DD- deficient data- insufficient data (according to European Red List of Vascular Plants, 2011)
EN- endangered (according to the Romanian Red Book of Vascular Plants, 2009).

In Zdl the species is reported in the sites ROSCI0022 Canaralele Dunării and ROSCI0053 Dealul Allah-Bair. Endemic species for Dobrogea. Xerophyte and saxicolous species. It grows in the cracks of limestone or granitic rocks, at altitudes of 200-300 m. Vegetation of rocks in Dobrogea. It is considered an element of Dobrogea (of the rocks areas) located only in Romanian Dobrogea, in quite poor populations. Given that it has been mentioned quite frequently in different localities in Dobrogea, it can be considered that it has a stable population.

2253 *Centaurea jankae* - Pannonian knapweed, Habitats Directive - Annexes II, IV

In Zdl the species is reported in ROSCI0071 Dumbraveni - Valea Urluia - Lacul Vederoasa (Dumbraveni - Urluia Valley - Vederoasa Lake). Herbaceous plant, solitary or numerous stems, up to 100 (120) cm high, edged, furrowed, simple or branched from the middle upwards. Glacial relic for Romania, endemic for Dobrogea (it is present only in Dobrogea). Indigenous, spontaneous species, important for Dobrogea, mentioned in the Red List of Superior Plants of Romania (Oltean & al. 1994), a species of community interest.

6927 *Himantoglossum jankae*- Lizard orchid Habitats Directive - Annexes II, IV, Berne Convention - Annex I, GEO 57/2007 - Annex 3, Law 49/2011

In Zdl the species is reported in ROSCI0072 Padurea si Valea Canaraua Fetii-lortmac. 30 - 110 cm tall plant, from the Orchidaceae family. Perennial species, xeromesophilous, subtermophilous, spread sporadically in steppe - forest-steppe areas, through bushes, glades and forest edges, grassy shores, on calcareous soil.

1428 *Marsilea quadrifolia* - Water clover - Habitats Directive - Annexes II, IV, Berne Convention - Annex I, GEO 57/2007 - Annex 3, Law 49/2011

In Zdl the species is reported in ROSCI0071 Dumbraveni-Valea Urluia-Lacul Vederoasa and ROSCI0072 Padurea si Valea Canaraua Fetii-lortmac. It is spread on the edge of eutrophic lakes, stagnant waters and lowland swamps, in shallow water - up to 40-50 cm.

2079 *Moehringia jankae* - Sandwort apetal - Habitats Directive - Annexes II, IV, DD- Data Deficient- Insufficient data (according to the European Red List of Vascular Plants, 2011) VU- vulnerable (according to the Romanian Red Book of Vascular Plants, 2009)

In Zdl the species is reported in ROSCI0022 Canaralele Dunării. This is an element of Dobrogea . Endemic European located in the western part of the Black Sea. It is a light, thermophilic plant of dry soils. It is a calciphile plant. Scio-saxicola.

The area is extremely limited. The species is native to Bulgaria and Romania. The species is considered endemic to Europe, an element of Dobrogea. It is mentioned especially in the northern part of Dobrogea (Tulcea County) to Hârșova. It is very rare, taxonomically close to *M.grisebachii* with which it can be easily confused, especially since they are in the same area.

6948 *Pontechium maculatum subsp. maculatum* / is synonymous with *Echium russicum* - Red-flowered viper's grass - Habitats Directive - Annexes II, IV, Berne Convention - Annex I, GEO 57/2007 - Annex 3, Law 49/2011

In Zdl the species is reported in ROSCI0071 Dumbraveni-Valea Urluia-Lacul Vederoasa and ROSCI0072 Padurea si Valea Canaraua Fetii-lortmac. It is spread through steppe meadows and bushes, orchards and meadows, from the plain area to the oak floor.

Widespread throughout the country. Rare species in Dobrogea, reported from: Măcin, Greci, Luncavița, Telița, Malcoci, Teche, Platoul Babadag, Dobromir, Canaraua Fetii, Esechioi, Hagieni

and Pădurea Dumbrăveni. Uncertain presence in the site ROSCI0172 Pădurea și Valea Canaraua Fetii - Iortmac according to the data from the site management plan.

2125 *Potentilla emilii-popii* - Five fingers plant - Habitats Directive - Annexes II, IV, Berne Convention - Annex I, GEO 57/2007 - Annex 3, Law 49/2011

In Zdl the species is reported in ROSCI0053 Dealul Allah Bair, ROSCI0071 Dumbraveni-Valea Urluia-Lacul Vederosa and ROSCI0072 Padurea si Valea Canaraua Fetii-Iortmac. Dobrogean subendemism, widespread in northeastern Bulgaria and southeastern Romania. Widespread in and the reservations of Pădurea Dumbrăveni, Pădurea Canaraua Fetii, Pădurea Esehioi, Dealul Allah Bair, Pădurea Hagieni, Independența.

2093 *Pulsatilla grandis* - Greater Pasque Flower - Habitats Directive - Annexes II, IV, Berne Convention - Annex I, GEO 57/2007 - Annex 3, Law 49/2011

In Zdl the species is reported in ROSCI0053 Allah Bair Hill. It is a heliophilous species, which grows in mountainous and hilly areas, in meadows, on branches, on dry, neutral soils, poor in nitrogen.

The species is considered uncertain for the Romanian flora. There is no credible confirmation of the species' presence in Zdl.

INVERTEBRATES

The Zdl of the project lists 10 species of invertebrates of Community conservation interest (ANNEX 6) [55, 66, 67, 69, 72, 81, 82]. The description of the species was made based on the consultation of the specialized literature.

4056 *Anisus vorticulus* - Lesser ramshorn snail - Habitats Directive - Annexes II, IV, Berne Convention - Annex I, GEO 57/2007 - Annex 3, 4A

In Zdl the species is reported in ROSCI0022 Canaralele Dunării. Species widespread in Central Europe in Russia to Obi, then in Sweden (Terrier et al. 2006). It seems that the only complex of aquatic ecosystems specific to *Anisus vorticulus*, where the effects of habitat fragmentation have not been manifested, would be Rezervația Biosferei Delta Dunării (the Danube Delta Biosphere Reserve).

4028 *Catopta thrips* - Steppe carpenter moth - Habitats Directive - Annexes II, IV, Berne Convention - Annex I, GEO 57/2007 - Annex 3, 4A

In Zdl the species is reported in ROSCI0071 Dumbraveni-Valea Urluia-Lacul Vederosa. The populations of Romania are extremely isolated, distributed in the Transylvanian Plain, Moldova and Dobrogea.

1088 *Cerambyx cerdo* - the Great capricorn beetle - Habitats Directive - Annexes II, IV, Berne Convention - Annex I, GEO 57/2007 - Annex 3, 4A

In Zdl the species is reported in ROSCI0072 ROSCI0072 Padurea si Valea Canaraua Fetii-Iortmac. It is one of the largest beetles in Europe (24-55 mm long). In Romania it is found sporadically throughout the country. In addition to the continental, steppe and low alpine bioregions, the species has also been reported near Timișoara, in the Pannonian bioregion (Serafim, 2009).

1074 *Eriogaster catax* - Eastern eggar - Habitats Directive - Annexes II, IV, Berne Convention - Annex I, GEO 57/2007 - Annex 3, 4A

In Zdl the species is reported in ROSCI0072 Padurea si Valea Canaraua Fetii-Iortmac and ROSCI0071 Dumbraveni-Valea Urluia-Lacul Vederosa. In Romania it is more common in Banat, Crișana and Transylvania. It is not present in Moldova, Muntenia and the Danube Delta. It is very rare in Dobrogea, where it is found only in the southwest (Canaraua Fetii and Pădurea Esehioi).

6169 *Euphydryas maturna* - Scarce fritillary - Habitats Directive - Annexes II, IV, Berne Convention - Annex I, GEO 57/2007 - Annex 3, 4A

In Zdl the species is reported in ROSCI0072 Padurea si Valea Canaraua Fetii-Iortmac. In Romania it is known to be present in Banat, Crişana, Transylvania, Muntenia (lowland area around Bucharest), northern Moldova and Dobrogea. It is missing from the Danube Delta and from mountainous areas higher than 800 meters. According to some authors, the populations from Dobrogea belong to the endemic subspecies *Euphydryas maturna opulenta* [62], morphologically and genetically differentiated from the other populations on the Romanian territory.

6199 *Euplagia quadripunctaria* - Jersey tiger - Habitats Directive - Annexes II, IV, Berne Convention - Annex I, GEO 57/2007 - Annex 3, 4A

In Zdl the species is reported in ROSCI0072 Padurea si Valea Canaraua Fetii-Iortmac. It is widespread in Romania except in the Danube Delta, where it is not yet known, although there are nearby populations in northern Dobrogea (at Enisala). Consequently, the presence of this species in the Danube Delta is not impossible. It is missing from the high mountain areas, at altitudes higher than 1,200 m.

1083 *Lucanus cervus* - Rădaşca - Habitats Directive - Annexes II, IV, Berne Convention - Annex I, GEO 57/2007 - Annex 3, 4A

In Zdl the species is reported in ROSCI0072 Padurea si Valea Canaraua Fetii-Iortmac and ROSCI0071 Dumbraveni-Valea Urluia-Lacul Vederosa. In Romania it is common throughout the country, except for the high alpine area. The species is also present in the Black Sea bioregion, in the Letea and Caraorman forests.

1060 *Lycaena dispar* - large copper - Habitats Directive - Annexes II, IV, Berne Convention - Annex I, GEO 57/2007 - Annex 3, 4A

In Zdl the species is reported in ROSCI0072 Padurea si Valea Canaraua Fetii-Iortmac and ROSCI0071 Dumbraveni-Valea Urluia-Lacul Vederosa. It has been reported throughout Romania, being a widespread and relatively common species. However, it is missing from the mountain areas, at altitudes of over 1,200 meters.

4053 *Paracaloptenus caloptenoides* - Paracaloptenus caloptenoides - Habitats Directive - Annexes II, IV, Berne Convention - Annex I, GEO 57/2007 - Annex 3, 4A

In Zdl the species is reported in ROSCI0072 Padurea si Valea Canaraua Fetii-Iortmac. In Romania it is found in the south and east of the country.

4043 *Pseudophilotes bavius* - Bavius blue - Habitats Directive - Annexes II, IV, Berne Convention - Annex I, GEO 57/2007 - Annex 3, 4A

In Zdl the species is reported in ROSCI0072 Padurea si Valea Canaraua Fetii-Iortmac. In Romania there are 2 subspecies: *Pseudophilotes bavius hungarica*, widespread in Transylvania (the most stable population is that of Suatu) and *Pseudophilotes bavius egea*, widespread only in central and southern Dobrogea, with only five populations known so far [46, 63, 64].

Fish

The Zdl of the project reports 15 species of fish of Community conservation interest (ANNEX 3) [40, 41, 42, 43, 66, 67, 69, 72, 81, 82].

14691 *Alosa immaculata* - Pontic shad, Habitats Directive - Annexes II and V, GEO 57/2007 - Annex 3, 5A

In Zdl the species is reported in ROSCI0022 Canaralele Dunării. The Pontic shad is a relatively small clupeid, the average body length being between 25 and 35 cm.

It is found all along the coast, and in the Danube along its route during the breeding season. Currently, its migration stops at the Porţile de Fier dam. It often reaches above Calarasi, rarely to Baziaş. In winter, they gather in front of the mouth of the Danube, waiting for the water to reach a temperature of at least 6 degrees Celsius in order to enter the river. *Alosa immaculata* undertakes annual migrations in the perimeter of the protected natural area, during March-July, in order to reproduce.

4127 Alosa tanaica - Black Sea shad, Habitats Directive - Annexes II and V, GEO 57/2007 - Annex 3, 5A

In Zdl the species is reported in ROSCI0022 Canaralele Dunării. The Black Sea shad can be found throughout the Black Sea coast, in the Danube (up to Calarasi) and its floodplains, as well as in the Razim-Sinoe lagoon complex.

1130 Aspius aspius- Asp, Habitats Directive - Annexes II and V, GEO 57/2007 - Annex 3.

In Zdl the species is reported in ROSCI0022 Canaralele Dunării, ROSCI0072 Padurea si Valea Canaraua Fetii-Iortmac and ROSCI0071 Dumbraveni-Valea Urluia-Lacul Vederosa. The Asp is considered a common and widespread species in Romania. It is found mainly in the following aquatic ecosystems: Danube (respectively in all floodplain and delta ponds), Complexul Razelm, coastal lakes, Tisa, Someș, Crișul repede, Mureș, Bega, Timiș, Cerna, Jiu, Olt, Vedea, Argeș, Neajlov, Ialomița, Siret, Prut, Suceava, Moldova, respectively Bistrița.

6963 Cobitis taenia Complex - Spined loach, Habitats Directive - Annexes II, GEO 57/2007 - Annex 3.

In Zdl the species is reported in ROSCI0022 Canaralele Dunării and ROSCI0071 Dumbraveni-Valea Urluia-Lacul Vederosa. According to BĂNĂRESCU (1964) [39], the Spined loach is mainly distributed in the following rheophilic aquatic ecosystems: Danube, Tur, Someșul Mic, Nadăș, Gădălin, Someș, Crasna, Moca, Beretău, Crișul Repede, Pețea, Crișul Negru, Crișul Alb, Rișculița, Mureș, Corunca, Arieș, Târnava, Valea Cladovei, Aranca, Begaberegsău, Niarad, Ier, Timiș, Șurgan, Pogonici, Caraș, Cerna, Jiu, Gilort, Olt, Hârtibaci, Olteț, Tezlui, Vedea, Argeș, Dâmbovița, Colentina, Neajlov, Ialomița, Călmățui, Siret, Prut, Suceava, Șomuz, Moldova, Bistrița Moldovenească, Miclov, Bârlad, Buzău etc.

2484 Eudontomyzon mariae - Ukrainian brook lamprey, Habitats Directive - Annexes II, GEO 57/2007 - Annex 3.

In Zdl the species is reported in ROSCI0022 Canaralele Dunării.

Rheophilic species that prefers flowing waters in the mountainous and sub-mountainous areas. Basin of the River Jiu (Gilort and Motru), Basin of the River Olt, Basin of the River Argeș (Vâlsan, Râul Doamnei, Bratia and Ilfov), Basin of the River Siret (Suceava, Moldova, respectively their tributaries), Danube (Giurgiu-Călărași sector) and Danube arms.

2555 Gymnocephalus baloni - Balon's ruffe, Habitats Directive - Annexes II and IV, GEO 57/2007 - Annexes 3 and 4A.

In Zdl the species is reported in ROSCI0022 Canaralele Dunării. It lives near the substrate, in deep but well oxygenated water. In Romania, the Balon's ruffe is found on the Danube, as well as in Mureș, the three Criș rivers, Timiș, Someș, Ialomița, Argeș, Olt, Vedea.

1157 Gymnocephalus schraetzer - The schraetzer, Habitats Directive - Annexes II and V, GEO 57/2007 - Annex 3.

In Zdl the species is reported in ROSCI0022 Canaralele Dunării. In Romania the schraetzer is found all along the Danube, from the river entering the country to the outflow. It is also found on the lower course of the rivers: Mureș, the three Criș rivers, Bega, Timiș, Siret, Prut. It seems to have disappeared from the Olt and Barcău rivers.

1145 Misgurnus fossilis - The weatherfish, Habitats Directive - Annexes II, GEO 57/2007 - Annex 3.

In Zdl the species is reported in ROSCI0022 Canaralele Dunării, ROSCI0072 Padurea si Valea Canaraua Fetii-Iortmac and ROSCI0071 Dumbraveni-Valea Urluia-Lacul Vederosa. In Romania, the species is present in most stagnant hilly and lowland waters, in the slow sectors and dead arms of rivers, up to the mountainous area. The literature indicates the presence of the weatherfish in the following aquatic ecosystems: Danube, Danube Delta, Razelm lagoon complex, Siutghiol and Tăbăcărie coastal lakes, Someșul Mic basin, Crasnei, Pețea river, Criș collector canal, Târnava, Aranca river, Bega, Ier, Timiș, Jiu basin, Olt basin, Argeș, Neajlov,

Dâmbovița, Colentina, Mostiștea, Ialomița, Siret, Suceava, Șomuz, moldavian part of Bistrita river, Buzău basin, Bârlat, Prut, respectively in all the ponds near the above rheophilic aquatic ecosystems.

2522 *Pelecus cultratus* - Ziege, Habitats Directive - Annexes II and V, GEO 57/2007 - Annex 3.

In Zdl the species is reported in ROSCI0022 Canaralele Dunării, ROSCI0072 Padurea si Valea Canaraua Fetii-Iortmac and ROSCI0071 Dumbraveni-Valea Urluia-Lacul Vederouasa. It prefers stagnant and flowing waters (rheophilic-stagnophilic species). The Ziege is found in the following rheophilic aquatic ecosystems: Danube (from the entrance to the country, to the outflow), Someș, Mureș, Bega, Timiș, Olt, Ialomița, Siret and Prut.

5339 *Rhodeus amarus* - European bitterling, Habitats Directive - Annexes II, GEO 57/2007 - Annex 3.

In Zdl the species is reported in ROSCI0022 Canaralele Dunării, ROSCI0072 Padurea si Valea Canaraua Fetii-Iortmac and ROSCI0071 Dumbraveni-Valea Urluia-Lacul Vederouasa. According to BĂNĂRESCU (1964) [39], the European bitterling is found in the following rheophilic aquatic ecosystems: Danube, Tisa, Iza, Sighet, Tur, Someșul Mare, Someșul Mic, Crasna, Beretău, Crișul Repede, Crișul Negru, Crișul Alb, Riscuțița, Criș collector canal, Toplița, Târnava Mare, Arieș, Strei, Bega, Timiș, Șurgan, Pogănici, Caraș, Nera, Cerna, Jiu, Olt, Argeș, Dâmbovița, Sabra, Ialomița etc.

6143 *Romanogobio kesslerii* - Kessler's gudgeon, Habitats Directive - Annexes II, GEO 57/2007 - Annex 3.

In Zdl the species is reported in ROSCI0022 Canaralele Dunării. According to BĂNĂRESCU (1964) [39], Kessler's gudgeon is mainly distributed in rheophilic aquatic ecosystems: Tur, Someșul Mare, Someșul Mic, Someș, Beretău, Crișul Repede, Mureș, Arieș, Târnava Mare, Sebeș, Beriu, Strei, Cerna, Olt, Sâmbăta, Cibin, Hârțibaciu, Olănești, Olteț, Vedea, Siret, Suceava, Șomuz, Moldova and Troțuș.

5329 *Romanogobio vladykovi* - Danube whitefin gudgeon, Habitats Directive - Annexes II, GEO 57/2007 - Annex 3.

In Zdl the species is reported in ROSCI0022 Canaralele Dunării, ROSCI0072 Padurea si Valea Canaraua Fetii-Iortmac and ROSCI0071 Dumbraveni-Valea Urluia-Lacul Vederouasa. The Danube whitefin gudgeon is mainly distributed in the following rheophilic aquatic ecosystems: Danube, Tur, Someș, Crasna, Beretău, Crișul Repede, Crișul Negru, Crișul Alb, Teuz, Mureș, Târnava, Bega, Timiș, Bârzava, Caraș, Berzeasca Olt, Vedea, Argeș, Ialomița, Siret and Prut.

5347 *Sabanejewia bulgarica* - Golden Loach, Habitats Directive - Annexes II and V, GEO 57/2007 - Annex 3.

In Zdl the species is reported in ROSCI0022 Canaralele Dunării. The Golden Loach is spread mainly in the following rheophilic aquatic ecosystems: Tisa, Vișeu, Iza, Tur, Crasna, Someșul Mare, Someșul Mic, Bistrița, Someșul Cald, Someșul Rece, Căpușul, Someș, Crișul Repede, Crișul Negru, Crișul Alb, Mureș, Arieș, Târnava Mare, Sebeș, Strei, Cerna, Bega, Timiș, Bârzava, Nera, Miniș, Cerna, Topolnița, Jiu, Olt, Siret, Suceava, Moldovița, Bistrița Moldovenească, Prut.

1160 *Zingel streber* - Danube streber, Habitats Directive - Annexes II and V, GEO 57/2007 - Annex 3.

In Zdl the species is reported in ROSCI0022 Canaralele Dunării. In Romania, the Danube streber is found in the following watercourses: Danube (from the entrance to the country to the outflow), Tisa, Iza, Vișeu, Tur, Someș, the Criș rivers, Mureș, Bega, Timiș, Nera, Cerna, Jiu, Motru, Siret, Moldova, the moldavian part of the river Bistrita, Prut.

1159 *Zingel zingel* - Zingel, Habitats Directive - Annexes V, GEO 57/2007 - Annex 3, 4A, 5A.

In Zdl the species is reported in ROSCI0022 Canaralele Dunării. It prefers areas with deep, clear water and strong currents. The Zingel is benthic, usually found among rocks. The Zingel is known

to exist in the Danube (from the entrance to the country until the outflow), the three Criş rivers, Someş, Someşul Mare, Mureş, Bega, Timiş, Jiu, Olt, Siret, Prut.

Amphibians

In Zdl of the project are reported 2 species of amphibians of community conservation interest (ANNEX 8), [42, 49, 65, 66, 67, 69, 72, 81, 82].

1188 *Bombina bombina* - The European fire-bellied toad, Habitats Directive - Annexes II, IV, GEO 57/2007 - Annex 3, 4A.

In Zdl the species is reported in ROSCI0022 Canaralele Dunării, ROSCI0172 Padurea si Valea Canaraua Fetii-lortmac, ROSCI0278 Bordusani - Borcea, ROSCI0071 Dumbraveni-Valea Urluia-Lacul Vederosa and ROSCI0319 Mlastina de la Fetesti. In Romania the species can be found in all regions and areas. It generally prefers larger ponds, permanent or semi-permanent, with rich marsh vegetation, swampy areas, but also slowly flowing waters (such as springs or irrigation canals).

1993 *Triturus dobrogicus* - Danube crested newt - Habitats Directive - Annex II, GEO 57/2007 - Annex 3, 4A.

In Zdl the species is reported in ROSCI0022 Canaralele Dunării, ROSCI0071 Dumbraveni-Valea Urluia-Lacul Vederosa and ROSCI0319 Mlastina de la Fetesti. In Romania, the species can be found from the plain area up to 250-300 m, in the southeast, south and west of the country.

Reptiles

In Zdl of the project are reported 4 species of reptiles of community conservation interest (ANNEX 9), [42, 49, 65, 66, 67, 69, 72, 81, 82].

5194 *Elaphe sauromates* - The Blotched snake - Habitats Directive - Annex II, IV, GEO 57/2007 - Annex 3, 4A.

In Zdl the species is reported in ROSCI0071 Dumbraveni - Valea Urluia - Lacul Vederosa (Dumbraveni - Urluia Valley - Vederosa Lake), ROSCI0172 Padurea si Valea Canaraua Fetii-lortmac and ROSCI0412 Ivrinezu. In Romania, the species can be found in the low hilly areas in the southeast of the country (it is possible to be present in the plain areas). It prefers open habitats or with rare arboreal-shrubby vegetation, shrubs, weeds, etc. It is usually found in wetter areas. It is sheltered under piles of stones, stone walls, or in bushes.

1220 *Emys orbicularis* - European pond turtle Habitats Directive - Annex II, GEO 57/2007 - Annex 3, 4A.

In Zdl the species is reported in ROSCI0022 Canaralele Dunării, ROSCI0071 Dumbraveni-Valea Urluia-Lacul Vederosa, ROSCI0172 Padurea si Valea Canaraua Fetii-lortmac, ROSCI0278 Borduşani-Borcea and ROSCI0319 Mlastina de la Fetesti.

In Romania the species can be found in all regions of the country, from lowlands to areas located at about 700 m alt. It prefers aquatic habitats (ponds, lakes, smooth rivers) in plain and hilly areas, with grassy and bushy vegetation on the shore, with aquatic vegetation and with important populations of fish and aquatic invertebrates. It is sensitive to water quality, not being found in polluted waters.

1219 *Testudo graeca* - Greek tortoise- Habitats Directive - Annex II, IV GEO 57/2007 - Annex 3, 4A.

In Zdl the species is reported in ROSCI0071 Dumbraveni - Valea Urluia - Lacul Vederosa (Dumbraveni - Urluia Valley - Vederosa Lake), ROSCI0172 Padurea si Valea Canaraua Fetii-lortmac and ROSCI0412 Ivrinezu. In Romania, the species can be found on the Dobrogean continental shelf and the ridges in the south of the Razim-Sinoie complex.

1217 *Testudo hermanni* - Hermann's tortoise -Habitats Directive - Annex II, IV GEO 57/2007 - Annex 3, 4A.

In Zdl the species is reported in ROSCI0071 Dumbraveni - Valea Urluia - Lacul Vederoasa (Dumbraveni - Urluia Valley - Vederoasa Lake) and ROSCI0172 Padurea si Valea Canaraua Fetii-lortmac. In Romania, the species can be found in the southeast of Banat, in the east of Oltenia, in the southwest of Dobrogea.

Mammals

In the Zdl of the project, nine species of mammals of community conservation interest are reported (ANNEX 10), [42, 54, 66, 67, 69, 72, 81, 82].

1355 *Lutra lutra* - Eurasian otter - Habitats Directive - Annex II, IV GEO 57/2007 - Annex 3, 4A.

In Zdl the species is reported in ROSCI0022 Canaralele Dunării, ROSCI0071 Dumbraveni-Valea Urluia-Lacul Vederoasa, ROSCI0172 Padurea si Valea Canaraua Fetii – lortmac, ROSCI0319 Mlastina de la Fetesti. The size of the Eurasian otter population at national level is estimated at about 3000 specimens, the tendency being to increase. The Eurasian otter is the largest semi-aquatic mustelid in Romania.

2609 *Mesocricetus newtoni* - Dobrudja hamster- Habitats Directive - Annex II, IV GEO 57/2007 - Annex 3, 4A.

In Zdl the species is reported in ROSCI0071 Dumbraveni - Valea Urluia - Lacul Vederoasa (Dumbraveni - Urluia Valley - Vederoasa Lake), ROSCI0022 Canaralele Dunarii, ROSCI0353 Pestera - Deleni, ROSCI0412 Ivrinezu. A species with limited distribution, being a Balkan endemism, which occurs only in Romania and Bulgaria, in low areas along the right bank of the lower Danube [51, 56]. In Romania, the area of the species is restricted to Podișul Dobrogei, being reported only in 28 locations in Tulcea and Constanța counties, and there is no recent data on the exact distribution of the species (Sándor DA unpub). There are no long-term assessments of the population trend, but the trend is declining. The decline of the population is mainly caused by the reduction and deterioration of habitats as a result of intensive agriculture [59]. The national population size is estimated at about 2000 specimens.

1310 *Miniopterus schreibersii* - Common bent-wing bat - Habitats Directive - Annex II, IV GEO 57/2007 - Annex 3, 4A.

In Zdl the species is reported in ROSCI0071 Dumbraveni - Valea Urluia - Lacul Vederoasa (Dumbraveni - Urluia Valley - Vederoasa Lake) and ROSCI0172 Padurea si Valea Canaraua Fetii-lortmac.

1321 *Myotis emarginatus* - Geoffroy's bat - Habitats Directive - Annex II, IV GEO 57/2007 - Annex 3, 4A.

In Zdl the species is reported in ROSCI0172 Padurea si Valea Canaraua Fetii-lortmac.

It is a species of medium size, body length 41-53 mm, forearm 36-42 mm.

1304 *Rhinolophus ferrumequinum* - The greater horseshoe bat - Habitats Directive - Annex II, IV GEO 57/2007 - Annex 3, 4A.

In Zdl the species is reported in ROSCI0172 Padurea si Valea Canaraua Fetii-lortmac.

The species is widespread in the South Plearctic - Central Asian-European corotype - and throughout Europe.

1303 *Rhinolophus hipposideros* - The lesser horseshoe bat - Habitats Directive - Annex II, IV GEO 57/2007 - Annex 3, 4A.

In Zdl the species is reported in ROSCI0071 Dumbraveni - Valea Urluia - Lacul Vederoasa (Dumbraveni - Urluia Valley - Vederoasa Lake) and ROSCI0172 Padurea si Valea Canaraua Fetii-lortmac.

Western Area - Palearctic and Marginal Afrotropical Turanic - European Mediterranean corotype and the whole of Europe.

1302 *Rhinolophus mehelyi*- Méhely's horseshoe bat- Habitats Directive - Annex II, IV GEO 57/2007 - Annex 3, 4A.

In Zdl the species is reported in ROSCI0071 Dumbraveni - Valea Urluia - Lacul Vederoasa (Dumbraveni - Urluia Valley - Vederoasa Lake) and ROSCI0172 Padurea si Valea Canaraua Fetii-Iortmac.

SV -Palearctic distribution -Mediterranean corotype- and the whole of Europe.

1335 *Spermophilus citellus*- European ground squirrel - Habitats Directive - Annex II, IV GEO 57/2007 - Annex 3, 4A.

In Zdl the species is reported in ROSCI0022 Canaralele Dunării , ROSCI0071 Dumbraveni-Valea Urluia-Lacul Vederoasa, ROSCI0172 Padurea si Valea Canaraua Fetii-Iortmac, ROSCI0353 Pestera- Deleni, ROSCI0412 Ivrinezu. Endemic species, widespread in Central and Southeastern Europe, at altitudes between 0 and 2500 m, the species area being geographically separated from the Carpathian Mountains in two areas, the northwestern part in the Czech Republic, Austria, Slovakia, Hungary, northern Serbia and Montenegro, and western Romania, and the southeastern part of southern Serbia, Macedonia, Greece, Turkey (Balkan Peninsula), Bulgaria, southern and eastern Romania, Moldova, and Ukraine. The species is extinct in Croatia and Germany, and reintroduced to Poland. In Romania it has a discontinuous spread, totally missing from the Transylvanian plateau and from other restricted areas. It is found outside the Carpathian arc to the borders of the country, in Moldova, Muntenia, Oltenia, Dobrogea, Banat, Crișana, at altitudes up to 450 m (Pietricica - Piatra Neamț hill) [44, 47, 61]. It is currently declining in Europe, and especially in the northern, north-western and southern parts of the range, with populations being fragmented. Population decline is mainly caused by habitat reduction and deterioration, as a result of infrastructure development, road traffic, conversion of pastures to agricultural land, intensive agriculture and abandonment of pastures by their gradual transformation into shrubs / tall grassy vegetation (Ben Shlimen et al., 2011, Kryštufek and Bryja 2009).

2635 *Vormela peregusna* - Marbled polecat- Habitats Directive - Annex II, IV GEO 57/2007 - Annex 3, 4A.

In Zdl the species is reported in ROSCI0071 Dumbraveni - Valea Urluia - Lacul Vederoasa (Dumbraveni - Urluia Valley - Vederoasa Lake) and ROSCI0172 Padurea si Valea Canaraua Fetii-Iortmac. In Romania it is found only in Dobrogea, with fragmented distribution, with several small populations in the southern and northern extremity of Constanța county, respectively in the north, southwest and east of Tulcea county. There are a total of 28 locations with marbled polecat sightings [58]. The marbled polecat national population is estimated at about 500 specimens [58].

Birds

The Zdl of the project lists 169 bird species, of which 70 are of Community conservation interest and are listed in Annex 1 of the Birds Directive. (ANNEX 11) [41, 42, 50, 52, 57, 60, 66, 67, 68, 70, 71, 72, 73, 81, 82].

Bird species listed in Annex I to Council Directive 79/409 / EEC which are found in the standard records of Natura 2000 sites in the Zdl

A402 *Accipiter brevipes* - Levant sparrowhawk - Birds Directive - Annex I, IV GEO 57/2007 - Annex 3, 4A.

It prefers mosaic habitats where there is no lack of forest bodies alternating with shrubs, agroecosystems and meadows. Intensification of agriculture and degradation of favorable habitats are the main dangers affecting the species.

A293 *Acrocephalus melanopogon* - Moustached warbler - Birds Directive - Annex I, IV GEO 57/2007 - Annex 3, 4A.

The main threats are habitat degradation, drainage, uncontrolled fires over very large areas, especially in the spring, the intensification of agriculture have a limiting effect on the species.

A229 *Alcedo atthis* - Common kingfisher - Birds Directive - Annex I, IV GEO 57/2007 - Annex 3, 4A.

Limiting factors are correlated with those that cause the degradation of riparian and wetland habitats.

A255 *Anthus campestris* - Tawny pipit - Birds Directive - Annex I, IV GEO 57/2007 - Annex 3, 4A.

At European level, populations are considered to be declining significantly due to intensive agricultural practices, the chemicalization of agriculture, the burning of stubble, and profound habitat changes.

A404 *Aquila heliaca* - Eastern Imperial Eagle - Birds Directive - Annex I, IV GEO 57/2007 - Annex 3, 4A.

Very rare species with an isolated distribution in the west, south and southeast of the country with a nesting population estimated in Romania at 1-3 pairs.

A089 *Aquila pomarina* - Lesser Spotted Eagle - Birds Directive - Annex I, IV GEO 57/2007 - Annex 3, 4A.

The main threats are the destruction of nesting sites by degrading and fragmenting forests, cutting down old trees, reducing trophic resources.

A029 *Ardea purpurea* - Purple Heron - Birds Directive - Annex I, IV GEO 57/2007 - Annex 3, 4A.

Limiting factors are correlated with those that cause the degradation of riparian and wetland habitats.

A024 *Ardeola ralloides* - Squacco heron - Birds Directive - Annex I, IV GEO 57/2007 - Annex 3, 4A.

Most important numbers in: Romania, Russia, Serbia, Ukraine, Turkey and Spain. Widespread species in wetlands, more numerous in Dobrogea, southern Moldova and Muntenia. The national population is estimated at 5,500 - 6,500 pairs.

Limiting factors are correlated with those that cause the degradation of riparian habitats and wetlands.

A060 *Aythya nyroca* - Ferruginous duck - Birds Directive - Annex I, IV GEO 57/2007 - Annex 3, 4A.

The largest European population is present in Romania (30-50%), concentrated mainly in the Danube Delta area.

Limiting factors are correlated with those that cause the degradation of riparian and wetland habitats.

A021 *Botaurus stellaris* - Eurasian bittern - Birds Directive - Annex I, IV GEO 57/2007 - Annex 3, 4A.

In Romania it is a fairly common species, present in all wetlands where compact reeds grow: the Danube Delta, Dranov Island, ponds and lakes along the Danube and large rivers or inland wetlands. Recently, there has been a slight expansion of the distribution area, in parallel with the expansion of areas with reeds, especially in the perimeters of artificial pools partially warped or abandoned.

It is a species associated with wetlands, especially swamps or stagnant waters, the presence of compact reeds and large areas being a strictly necessary factor. From this perspective, the limiting factors are those related to warping and drying of wetlands, water pollution and other disruptive factors.

A396 *Branta ruficollis* - Red-breasted Goose - Birds Directive - Annex I, IV GEO 57/2007 - Annex 3, 4A.

It appears in Romania between October and March, mainly in Dobrogea and in the counties of Brăila, Ialomița and Călărași. Smaller numbers can be found in certain periods in the rest of the country.

A population of 4,300 - 21,500 of them winter in Romania.

A215 *Bubo bubo* - Eurasian eagle-owl - Birds Directive - Annex I, IV GEO 57/2007 - Annex 3, 4A.

In Romania, the species is present mainly in areas of Transylvania, Dobrogea and Moldova but also in other regions of the country, relatively localized.

A133 *Burhinus oedicnemus* - Eurasian stone-curlew - Birds Directive - Annex I, IV GEO 57/2007 - Annex 3, 4A.

It nests mainly in Dobrogea, but can also be found in Oltenia and Muntenia. The national population is estimated at 500-1000 pairs.

A403 *Buteo rufinus* - long-legged buzzard - Birds Directive - Annex I, IV GEO 57/2007 - Annex 3, 4A.

In Romania it nests only in the south of the country, but it seems that its area is expanding. The European population of the species is estimated at 8700-15,000 nesting pairs.

A243 *Calandrella brachydactyla* - The greater short-toed lark - Birds Directive - Annex I, IV GEO 57/2007 - Annex 3, 4A.

In Romania it nests in Dobrogea and Bărăgan, but a small population was also found in Banat. The European population is large, between 7,300,000 and 14,000,000 pairs. It declined significantly between 1970 and 1990. In Romania, the estimated nesting population is 10,000-20,000 pairs.

A149 *Calidris alpina* - Dunlin - Birds Directive - Annex I, IV GEO 57/2007 - Annex 3, 4A.

In Romania, the species frequently migrates to ponds, rivers, dead tributaries of rivers or canals. The populations that cross Romania during the passages are estimated between 10,000 and 30,000 specimens.

A224 *Caprimulgus europaeus* - European nightjar - Birds Directive - Annex I, IV GEO 57/2007 - Annex 3, 4A.

In Romania it is found from Lunca Dunării to the mountainous areas of the Carpathians, probably much more widespread in the plains. The population in Europe is estimated at 470,000 to 1,000,000 pairs, effectively declining due to the disappearance of habitats preferred by the species and the excessive use of pesticides in agriculture and forestry. The number in the country is estimated at 3,000-15,000 nesting pairs.

A138 *Charadrius alexandrinus* - Kentish Plover - Birds Directive - Annex I, IV GEO 57/2007 - Annex 3, 4A.

In Romania, between 500 and 1,000 specimens can be seen during the passages, and the nesting population is estimated at 300-500 hatching pairs.

A196 *Chlidonias hybridus* - Whiskered Tern - Birds Directive - Annex I, IV GEO 57/2007 - Annex 3, 4A.

In Romania, the nesting population is 16,000-20,000 pairs, and during the passages between 25,000 and 70,000 specimens can be observed.

A198 *Chlidonias leucopterus* - White-winged tern - Birds Directive - Annex I, IV GEO 57/2007 - Annex 3, 4A.

In Romania it nests in sporadic populations, especially in the region of Dobrogea and Câmpia de Vest. During the winter it migrates to Africa, South Asia and Australia. In winter, it can go to North America, especially on the Atlantic coast, with specimens being reported both on the Pacific coast and inland, in the Great Lakes area. According to the current data, the nesting populations in

Romania are small, estimated between 100 and 300 pairs. It is found on lakes, stagnant water marshes, rivers, flooded areas and on water surfaces surrounded by reeds, sedges or other aquatic plants.

A197 *Chlidonias niger* - Black tern - Birds Directive - Annex I, IV GEO 57/2007 - Annex 3, 4A.

The estimated population in Romania is 300-800 nesting pairs, and during the passages between 3,000 and 10,000 specimens can be observed.

A031 *Ciconia ciconia* - White stork - Birds Directive - Annex I, IV GEO 57/2007 - Annex 3, 4A.

The estimated population in Romania is 5,000-6,000 pairs. During the passages, between 100,000 and 300,000 specimens can be observed in Romania. The white stork is a species characteristic of wet pastures and swamps.

A030 *Ciconia nigra* - Black stork - Birds Directive - Annex I, IV GEO 57/2007 - Annex 3, 4A.

The estimated population in Romania is 400-800 hatching pairs. During the passages the country is crossed by 10,000-20,000 individuals. The black stork is a species characteristic of lowland forests and areas with nearby wetlands.

A080 *Circaetus gallicus* - The short-toed snake eagle - Birds Directive - Annex I, IV GEO 57/2007 - Annex 3, 4A.

In Romania, the estimated population is 300-600 nesting pairs. The short-toed snake eagle is a species that prefers a mosaic of habitats with wooded areas used for nesting and open areas preferred for feeding.

A081 *Circus aeruginosus* - Marsh Harrier - Birds Directive - Annex I, IV GEO 57/2007 - Annex 3, 4A.

At the national level, the Marsh Harrier is a widespread nesting species, very common in the Danube Delta and rarer in Transylvania. Not present in the mountains. It is found mainly during the transition periods and in the nesting season. In the cold season it can be observed wintering only in Dobrogea and in the southernmost areas of Romania. The population of Romania is considered to have an upward trend. Marsh Harrier is a species that prefers wetlands with extensive reeds for nesting. It is less common in intensive crops (e.g. cereals).

A082 *Circus cyaneus* - Hen harrier - Birds Directive - Annex I, IV GEO 57/2007 - Annex 3, 4A.

In Romania it appears in migration and during the winter, especially in Dobrogea, the numbers that winter in Romania being estimated between 2,000 and 6,000 specimens. Hen harrier is a species characteristic of open areas, with pastures, swamps and agricultural lands. Outside the nesting season, they sometimes gather for overnight stays in large numbers.

A083 *Circus macrourus* - Pallid harrier - Birds Directive - Annex I, IV GEO 57/ 2007 - Annex 3, 4A.

In Romania, the estimated population is a maximum of 2 nesting pairs, and during the passages between 200 and 1,000 specimens can be observed. The Pallid harrier is a characteristic species of dry pastures and steppes, agricultural lands and swamps near rivers.

A084 *Circus pygargus* - Montagu's Harrier - Birds Directive - Annex I, IV GEO 57/2007 - Annex 3, 4A.

In Romania, the estimated population is 20-50 pairs. The Montagu's Harrier is a species characteristic of open areas, dry steppes, agricultural lands near rivers, lakes or seas.

A231 *Coracias garrulus* - Roller - Birds Directive - Annex I, IV GEO 57/2007 - Annex 3, 4A.

In Romania, it nests in the plain and hill regions of Banat, Crişana, Oltenia, Muntenia, Dobrogea and Moldova, missing from Transylvania. Europe represents more than half of the total area of the species, with relatively small nesting populations (53,000-110,000 pairs). For Romania, the estimated population is 4,600-6,500 nesting pairs. It prefers the warm and dry plains, which have patches of forest or solitary trees, and can occasionally be found in hilly regions. Prefers semi-open, mosaic habitats with solitary trees or groups of trees.

A238 *Dendrocopos medius* - Middle Spotted Woodpecker - Birds Directive - Annex I, IV GEO 57/2007 - Annex 3, 4A.

In Romania, the most significant nesting populations can be found in the hilly areas of Podișul Transilvaniei, respectively in the Oak woods of Dobrogea, but the species appears in most areas where the characteristic habitats are present. In Romania, approximately 80,000-250,000 pairs nest. It is a species that is found in forests with mature specimens of *Quercus*, but can also be observed in larger parks or on wooded pastures, where old specimens of oak or sessile oak are present. The altitudinal limits at which the species nests are determined by the presence of oak or sessile oak habitats and are located mainly between 200 and 600 m; in Dobrogea and Câmpia de Vest it can also be found at lower altitudes. The presence of the species is independent of the slope of the land, humidity or proximity of watercourses. It also lives in mixed forests with oak, hornbeam, ash, beech, even spruce. The spread of the species generally corresponds to the spread of hornbeam (*Carpinus betulus*).

A429 *Dendrocopos syriacus* - Syrian Woodpecker - Birds Directive - Annex I, IV GEO 57/2007 - Annex 3, 4A.

The population of Romania is estimated to be between 10,000 and 30,000 pairs and is declining. It is not a pretentious species, being present in forests, parks, farms, wooded pastures or gardens. It is the most anthropogenic species of woodpecker, with the majority of the population nesting in gardens or near localities, respectively in secondary habitats, with a strong anthropogenic impact (for example in the poplar strips on the roadsides). It avoids large and closed forests, rather favoring groups of trees, forest edges, old, isolated trees, etc. It is also present in deciduous and coniferous forests, where tree trunks exceed 25 cm in diameter.

A236 *Dryocopus martius* - Black woodpecker - Birds Directive - Annex I, IV GEO 57/2007 - Annex 3, 4A.

The largest populations nest in Poland, Belarus, Russia and Romania. In Romania, the species was considered - until the last decades of the twentieth century - to be specialized in beech and spruce forests in mountainous areas. In recent decades, however, the population has undergone a sharp expansion and has become a widespread species, with a general distribution, but not uniform. It is missing from large areas without forests and at altitudes above the forest boundary (1,700 m). It is rarer in lowland areas with arid microclimate and in arid forests of the steppe bioregion. It is a common nesting species in the Danube Delta.

A027 *Egretta alba* - Great White Egret - Birds Directive - Annex I, IV GEO 57/2007 - Annex 3, 4A.

At the national level it is a nesting species with the vast majority of the population located in the Danube Delta. In the rest of the country it is present mainly in the east and south of Moldova, the south and west of the country (Banat and Crișana), but also insular inland, especially in wetlands with reeds and wetlands on large areas or along the seas, rivers. In recent decades, the area of spread has been growing. The population of Romania (most of which is in the Danube Delta) was estimated at 210-370 nesting pairs. Between 1,000 and 3,000 specimens winters in Romania, and between 3,600 and 5,700 specimens can be seen during the passages. The species prefers ponds and wetlands on large areas, with reeds, flooded meadows, canals, ponds, etc.

A026 *Egretta garzetta* - Little egret - Birds Directive - Annex I, IV GEO 57/2007 - Annex 3, 4A.

The estimated population in Romania is about 4,000-8,000 pairs, with larger numbers present in Italy, France, Spain, Azerbaijan and Russia. During the passages, between 5,000 and 8,000 specimens can be seen on the Romanian territory. It prefers swampy areas, deltas and ponds, with clumps of trees needed for nesting.

A379 *Emberiza hortulana* - Ortolan - Birds Directive - Annex I, IV GEO 57/2007 - Annex 3, 4A.

In Romania, the number of species is between 225,000 and 550,000 nesting pairs. The Ortolan prefers cornfields and neighboring lands.

A511 *Falco cherrug* - Saker Falcon - Birds Directive - Annex I, IV GEO 57/2007 - Annex 3, 4A.

In Romania, the Saker Falcon is a nesting species in Câmpia de Vest and in Dobrogea. There are also sporadic reports in favorable plains habitats throughout the year, with young or sometimes even adults being observed in these regions, especially in areas with a rich diet. It is estimated that between 360 and 540 pairs are present in Europe. In Romania, this species was quite common in the past, but suffered a dramatic decline, reaching only 6-10 pairs in Câmpia de Vest and Dobrogea. It is not excluded at all that such pairs of Saker Falcons still exist in the plain regions of Bărăgan, Moldova or in Câmpia Română, so that this estimate can be easily underestimated. During the passages, between 40 and 60 specimens can be observed on the territory of Romania.

A103 *Falco peregrinus* - Peregrine falcon - Birds Directive - Annex I, IV GEO 57/2007 - Annex 3, 4A.

After the 1970s, it seems that the numbers in Romania have disappeared, but now they are in a spectacular recovery, settling in more and more areas. Thus, nesting pairs from the entire Carpathian chain are known, nesting being possible also in Dobrogea. Thus, approximately 135-250 nesting pairs are estimated to be present. The peregrine falcon is a species characteristic of open, rocky, tundra areas, pastures or steppes with patches of forest and sea shores. It can be found up to an altitude of 4,000 m.

A097 *Falco vespertinus* - Red-footed Falcon - Birds Directive - Annex I, IV GEO 57/2007 - Annex 3, 4A.

The nesting population in Romania is estimated to be between 1,000 and 1,500 pairs and follows the European population trend, declining. Between 7,000 and 20,000 specimens can be seen during the passages. Typical plain species, which prefers open areas that alternate with clumps of trees in steppe and forest-steppe habitats, but does not dislike clumps of trees between arable land.

A321 *Ficedula albicollis* - Collared Flycatcher - Birds Directive - Annex I, IV GEO 57/2007 - Annex 3, 4A.

In Romania, the nesting population is estimated at 500,000-1,500,000 pairs, being among the largest populations in Europe. The Romanian Collared Flycatcher population together with the Ukrainian population represents more than half of the total European nesting population. The small bird is characteristic of deciduous forests. It is not easily scared, and can be found frequently nesting in localities, parks, orchards and gardens.

A320 *Ficedula parva* - Red-breasted flycatcher - Birds Directive - Annex I, IV GEO 57/2007 - Annex 3, 4A.

In Romania, the nesting population is estimated at 80,000-260,000 pairs, being surpassed in size only by the population of Russia. The Red-breasted flycatcher prefers forests over 100 years old, which have a large amount of dead wood and a low layer of shrubs. The species avoids young forests under 44 years. In Romania it breeds in the higher regions of the Carpathian Mountains, where it is found in deciduous or mixed forests, in shady areas, slightly humid.

A075 *Haliaeetus albicilla* - White-tailed eagle - Birds Directive - Annex I, IV GEO 57/2007 - Annex 3, 4A.

It is a more widespread species in northern, central and eastern Europe. In Romania, it prefers riparian forests near wetlands, located up to an altitude of 200 m, the main breeding population in the country being in Dobrogea, in the Danube area. In Romania, the estimated population is 55-75 pairs, and in winter the numbers can reach about 110-220 individuals, with a slightly increasing population trend. The White-tailed eagle is a bird characteristic of open areas in the region of sea coasts and freshwater lakes, near which there are old trees or rocky islands.

A092 *Hieraetus pennatus* - Booted eagle - Birds Directive - Annex I, IV GEO 57/2007 - Annex 3, 4A.

In Romania, the Booted eagle nests in larger numbers in the Dobrogea region, but there is relatively recent evidence of nesting pairs in other lowland regions such as Câmpia de Vest. The

number of pairs valued at European level is between 4,400 and 8,900 pairs. The majority of the population is in Russia and Spain, while in Romania we have an estimated number of 150-320 nesting pairs.

A131 *Himantopus himantopus* - Black-winged stilt - Birds Directive - Annex I, IV GEO 57/2007 - Annex 3, 4A.

In Romania it is distributed along the Danube, of the lagoon complex and in the Danube Delta, being sporadically found in the interior of the country, where there are wetlands with a larger surface. In Romania the estimated population is 900-2,000 pairs. Between 1,500 and 6,000 specimens can be seen in the country during the passages. The Black-winged stilt is a species characteristic of shallow waters, inland waters and sea coasts.

A022 *Ixobrychus minutus* - Little bittern - Birds Directive - Annex I, IV GEO 57/2007 - Annex 3, 4A.

In Romania, this species is widespread mainly in the Danube Delta, but also in wetlands inland, where habitat conditions are met.

A338 *Lanius collurio* - Red-backed shrike - Birds Directive - Annex I, IV GEO 57/2007 - Annex 3, 4A.

In Romania, the estimated number of pairs is 1,600,000-3,600,000, being one of the most numerous populations in Europe.

A339 *Lanius minor* - Lesser grey shrike - Birds Directive - Annex I, IV GEO 57/2007 - Annex 3, 4A.

In some countries the numbers remained stable between 1990–2000, however in most countries there was a decrease, including in Romania, which currently has one of the largest nesting numbers (65,000-130,000 pairs).

A176 *Larus melanocephalus* - Mediterranean gull - Birds Directive - Annex I, IV GEO 57/2007 - Annex 3, 4A.

The Mediterranean gull is an almost entirely European species, widespread in coastal areas from the North Sea to the Mediterranean Sea and the Black Sea. In Romania, the estimated number is 50-300 nesting pairs, and during migration the population can reach 15,000-50,000 individuals. The Mediterranean gull is a species characteristic of wet, open, lagoon and coastal areas. Easily adapts to different habitat types; in migration it appears in wetlands, lakes, lagoon and coastal areas, but also in agricultural areas and pastures.

A177 *Larus minutus* - Little Gull - Birds Directive - Annex I, IV GEO 57/2007 - Annex 3, 4A.

It winters in Europe and on the Caspian and Black Sea coasts.

A246 *Lullula arborea* – Woodlark - Birds Directive - Annex I, IV GEO 57/2007 - Annex 3, 4A.

In Romania it has an almost homogeneous distribution appearing in all habitats corresponding to the species, with sedentary populations in Lunca Dunării and in Dobrogea. The nesting population in Romania is estimated at between 100,000 and 250,000 pairs. It nests in various open and semi-open habitats, mosaic with shrubs, in agricultural areas and abandoned pastures, extensively in traditionally treated orchards, in forest edges and in the natural regeneration of forest habitats.

A242 *Melanocorypha calandra* - Calandra lark - Birds Directive - Annex I, IV GEO 57/2007 - Annex 3, 4A.

In Romania there are nesting populations in the Danube Delta, in Dobrogea, in the southern part of Moldova and in the eastern part of Muntenia. The numbers in Romania are estimated at 750,000-1,500,000 nesting pairs. It occupies territories in open plains, steppe areas, pastures and unirrigated arable land, with dense vegetation, preferring perches, stubble and field edges. It can also be found nesting in cultivated land, showing a preference for cereal crops. Avoids deserts and semi-deserts, but also rocky areas.

A073 *Milvus migrans* - Black kite - Birds Directive - Annex I, IV GEO 57/2007 - Annex 3, 4A.

Until the beginning of the 20th century, the Black kite was the most widespread and numerous bird of prey in the country, being found mainly along the watercourses in the hilly and plain areas, including the Delta. Today it is very rarely nesting in Romania, appearing in greater numbers only in the passage, especially in Dobrogea.

A023 *Nycticorax nycticorax* - Black-crowned Night-Heron - Birds Directive - Annex I, IV GEO 57/2007 - Annex 3, 4A.

In Romania, it is present as a nesting species, especially in the meadow and Danube Delta, in the meadows of large rivers and floodplains along them, but also in other wetlands inland, being more numerous in Muntenia and Moldova.

A533 *Oenanthe pleschanka* - Pied Wheatear - Birds Directive - Annex I, IV GEO 57/2007 - Annex 3, 4A.

In Romania it nests along the Black Sea coast and in the rest of Dobrogea, being the most western signaling of nesting for this species.

A094 *Pandion haliaetus* - Osprey - Birds Directive - Annex I, IV GEO 57/2007 - Annex 3, 4A.

In Romania it is a species found in the wetlands in the eastern part of the country, in the Danube Delta, in coastal lagoons and in Dobrogea. It also occurs in several humid habitats and ponds in western Romania.

The Osprey is a species characteristic of regions with permanent, stagnant or slow-moving aquatic habitats, with fresh, brackish or salt water.

A020 *Pelecanus crispus* - Dalmatian pelican- Birds Directive - Annex I, IV GEO 57/2007 - Annex 3, 4A.

In Romania, the nesting population is estimated at 240-330 pairs. During the migration, the numbers in Romania are between 900 and 1,800 individuals, and during the winter there can be between 100 and 800 individuals. The species is found mainly in the continental area, in freshwater aquatic habitats, but also in coastal lagoons, deltas and estuaries. In Romania, it nests in the Danube Delta next to the great white pelican, *Pelecanus onocrotalus*, but also isolated, in small colonies of several dozen pairs, in the southern part of the Danube Delta and the Razim-Sinoe lagoon complex.

A019 *Pelecanus onocrotalus*- The great white pelican - Birds Directive - Annex I, IV GEO 57/2007 - Annex 3, 4A.

The great white pelican is spread over a large area, but is distributed insularly in it, the species being found from Eastern Europe (Danube Delta) to eastern Mongolia. The Danube Delta Biosphere Reserve (Rezervația Biosferei Delta Dunării) is the traditional nesting place for the great white pelican (4,100-4,500 pairs). 60-100 years ago it was a nesting species common throughout the lower Danube. During 1990–2000 the population remained stable in Romania, being the symbol for the Danube Delta.

A072 *Pernis apivorus* - Honey Buzzard - Birds Directive - Annex I, IV GEO 57/2007 - Annex 3, 4A.

In Romania, the nesting population is estimated at 5,000-12,000 pairs. The Honey Buzzard is a characteristic species of deciduous forests with meadows, located on light and dry soils, in which it can easily dig for food.

A393 *Phalacrocorax pygmeus* - Pygmy Cormorant - Birds Directive - Annex I, IV GEO 57/2007 - Annex 3, 4A.

The Pygmy Cormorant nests in southern Europe and southwest Asia. It is found along the entire coast of the Mediterranean Sea and the Black Sea, as well as on the shores of the Caspian Sea. In Romania the species is partially migratory, wintering mainly on stagnant, inland, unfrozen waters or even on large rivers, and in summer can be seen on the surface of the water in most

aquatic habitats (fisheries, reservoirs, Danube, Razelm-Sinoe lagoon complex, Danube Delta, large rivers, etc.).

A170 *Phalaropus lobatus* - The red-necked phalarope - Birds Directive - Annex I, IV GEO 57/2007 - Annex 3, 4A.

In Romania, the species appears in the passage, more frequently observed in September.

A151 *Philomachus pugnax* - Ruff - Birds Directive - Annex I, IV GEO 57/2007 - Annex 3, 4A.

In Romania, the number that is seen during the passages is 35,000-100,000 individuals. The species nests in tundra habitats from the edge of forests to the shores of the Arctic Ocean.

A234 *Picus canus* - Grey-headed Woodpecker - Birds Directive - Annex I, IV GEO 57/2007 - Annex 3, 4A.

It is a species with a wide distribution in Romania, in some areas it can even be considered common. In Europe, 180,000-320,000 pairs nest, the population is considered stable, although according to the latest estimates the trend cannot be determined. In Romania, between 30,000 and 60,000 pairs nest, which is the largest population on the continent.

A034 *Platalea leucorodia* - Eurasian Spoonbill - Birds Directive - Annex I, IV GEO 57/2007 - Annex 3, 4A.

The nesting population in Romania is estimated at 600-1,200 pairs, with larger numbers being recorded only in Russia and Spain. The Eurasian Spoonbill is a characteristic species of shallow ponds and lakes with reeds and clumps of trees.

A032 *Plegadis falcinellus* - Glossy ibis - Birds Directive - Annex I, IV GEO 57/2007 - Annex 3, 4A.

In Romania, the most important colonies are in the Danube Delta. The estimated population of the species is small and between 16,000 and 22,000 nesting pairs. The estimated nesting population in Romania is 2,000-3,000 pairs. The species does not winter in Romania, but can be observed during migration with large numbers of between 5,000 and 7,000 individuals. It is a species characteristic of lakes, ponds and swamps, but can also be observed in wet pastures, on river banks with little water, in abundant riparian vegetation and in reeds with willow clumps.

A120 *Porzana parva* - Little crane - Birds Directive - Annex I, IV GEO 57/2007 - Annex 3, 4A.

In Romania, the species is found mainly in the Danube Delta area, along the Danube and in several areas of Transylvania.

A132 *Recurvirostra avosetta* - Pied avocet - Birds Directive - Annex I, IV GEO 57/2007 - Annex 3, 4A.

In Romania it is spread along the Danube and the Danube Delta. In Romania, the estimated population is 700-1,800 pairs, and during the winter the numbers of the species in Romania are estimated at 1,500-6,000.

A195 *Sterna albifrons* - Little tern - Birds Directive - Annex I, IV GEO 57/2007 - Annex 3, 4A.

The estimated population in Romania is 200-600 nesting pairs, and in the passage approximately 1,000-3,000 individuals pass through Romania. The little tern is characteristic of coastal wetlands, but also of inland freshwater lakes, located at a distance of several kilometers from the sea.

A193 *Sterna hirundo* - Common tern - Birds Directive - Annex I, IV GEO 57/2007 - Annex 3, 4A.

In Romania, the nesting population with the largest number is in the Danube Delta, but important populations can be found in the interior of the country, where it finds favorable habitats. The estimated population in Romania is 6,600-6,900 nesting pairs, and during migration there may be between 10,000 and 40,000 individuals.

A307 *Sylvia nisoria* - Barred warbler - Birds Directive - Annex I, IV GEO 57/2007 - Annex 3, 4A.

In Romania, the nesting population is estimated at 165,000–330,000 pairs.

A397 *Tadorna ferruginea* - Ruddy shelduck - Birds Directive - Annex I, IV GEO 57/2007 - Annex 3, 4A.

In Romania this species can be found in aquatic areas in the southeast of the country and only occasionally, during migration, can be observed in the rest of inland waters. In Romania, about 40-70 pairs nest. During the nesting season, this species frequents the shores of inland waters, fresh or salty, lakes and rivers in open areas, especially those in the steppe areas, high plateaus and mountainous areas. It is less dependent on large bodies of water than other species of ducks and geese.

A166 *Tringa glareola* - Wood sandpiper - Birds Directive - Annex I, IV GEO 57/2007 - Annex 3, 4A.

In Romania, it is a passage species, being present in spring in April and May, and in autumn in August and September. The species is also vulnerable to industrial pollution and disruption caused by human activities such as fishing.

Regularly migratory bird species not listed in Annex I to Council Directive 79/409 / EEC which are found in the standard records of Natura 2000 sites in the Zdl

A086 *Accipiter nisus* - Eurasian sparrowhawk

It is a widespread species in almost all of Europe. In Romania, it nests all over the country, being less common in Câmpia Română and in Moldova between Prut and Siret. The estimated number in Romania is 4,000 to 12,000 nesting pairs.

A298 *Acrocephalus arundinaceus* - Great reed warbler

In Romania, it is widespread in the Danube Delta and in the reed ponds in the rest of the country, where it is present in the summer season, leaving the nesting places in August, when it migrates to West and Central Africa. The population of Great reed warblers in Romania reaches 370,000-426,000 nesting pairs.

A296 *Acrocephalus palustris* - Marsh Warbler

In Romania, it nests in the plain areas in the western and eastern parts of the country, in Depresiunea Transilvaniei, in Lunca Dunarii and Danube Delta and in Dobrogea. The number of this species in Romania is estimated at 97,000-126,000 nesting pairs.

A295 *Acrocephalus schoenobaenus* - Sedge warbler

In Romania it is spread all over the country, except the Carpathians. In Romania, between 87,000 and 115,000 pairs nest, the population being stable. It is a common summer guest in Europe, with more than half of the global population nesting here.

A297 *Acrocephalus scirpaceus* - Eurasian Reed Warbler

In Romania it has a homogeneous spread, avoiding only the relatively extreme elevations in the Carpathians. The population of Romania is estimated between 128,000 and 161,000 nesting pairs, being considered stable. It occupies old reed habitats along lakes, rivers, swamps and canals, often procuring food from nearby open bush habitats. It rarely appears on agricultural land.

A168 *Actitis hypoleucos* - Common sandpiper

In Romania, between 5,200 and 9,600 pairs nest annually. The European population consists of 720,000 to 1,600,000 nesting pairs and is considered a species in moderate decline. The species is characteristic of areas with poor vegetation on the banks of rivers, streams and lakes.

A247 *Alauda arvensis* - Eurasian Skylark

The species is widespread in Romania, preferring open lands. Most of the population in Romania migrates to Mediterranean areas, very few specimens remaining with us over the winter. It is widespread in Romania, the number of nesting pairs being estimated at 2,000,000-3,000,000.

A054 *Anas acuta* - Northern pintail

On the Romanian territory, this species can be found especially during the winter and the passage period, the nesting pairs being few. In Romania, the nesting population is erratic, being evaluated by BirdLife International at a maximum of 5 pairs. However, between 400 and 1,000 individuals of this species winter in Romania.

A056 *Anas clypeata* - Northern shoveler

Predominantly migratory species, with a very large area, which covers almost the entire hemisphere. In Romania it can be found all year round in most low altitude aquatic areas. During the winter, the smallest groups are registered, because the main wintering areas are located south of Romania. From a quantitative point of view, the largest numbers are registered during migration periods. It nests relatively localized, especially in Dobrogea, Muntenia, Oltenia, Moldova and in Banat.

A052 *Anas acuta* - Northern pintail

In Romania it can be found especially in the passage and in winter, in a variety of aquatic habitats: shallow coastal waters, natural and artificial lakes, ponds, estuaries, deltas, lagoons and swamps. During the nesting period, there are small populations in Transylvania and northern Moldova, in mountainous areas and coastal aquatic areas. The number of Northern pintails nesting in Romania is 5-30 pairs

A050 *Anas penelope* - Eurasian wigeon

The Eurasian wigeon can be found all over Romania, in low altitude aquatic areas, in winter or in transit, especially near the Black Sea. The group that winters in Romania has been estimated at 1,000-6,000 individuals, and the one that transits during the passages is 12,000-25,000 individuals.

A053 *Anas platyrhynchos* - Mallard

In Romania it can be found in most aquatic areas that correspond to the preferred habitat type, especially those of low and medium altitude. Our Mallard population in the country is estimated at 62,000-75,000 nesting pairs. During the winter, between 100,000 and 250,000 specimens can be observed.

A055 *Anas querquedula* – Garganey

In Romania it can be found nesting in fresh, shallow, well-sheltered waters. The nesting population in Romania is estimated at 1,600-4,100 pairs.

A051 *Anas strepera* – Gadwall

In Romania, the Gadwall can be found in low altitude aquatic areas, open, with shallow water, standing water or slightly flowing water.

A041 *Anser albifrons* - Greater white-fronted goose

In Romania it can be found only in winter, in the areas near the Danube, in Transylvania and in Câmpia de Vest.

A043 *Anser anser* - Greylag Goose

In Romania, the Greylag Goose can be found near open, low-altitude aquatic areas, especially along the Danube.

A256 *Anthus trivialis* - Tree pipit

In Romania it is widespread throughout the country, missing from the plain areas in the south of Moldova and from Dobrogea. The nesting population in Europe is extremely large (27,000,000-42,000,000 pairs). In Romania, approximately 500,000- 900,000 pairs nest. Habitats used by the species include deciduous and coniferous forests, clearings, tall, isolated tree cuttings, edges and hilly or mountainous areas.

A028 *Ardea cinerea* - Grey heron

In Romania it is found in all areas of the country, in wetlands and in the area of large bodies of water, generally in the areas of plains and hills, but it can be found even up to higher altitudes, in the area of accumulation lakes.

A221 *Asio otus* - Long-eared Owl

In Romania, this species is found throughout the year, both during the nesting period and during the cold season, being present in most regions of Romania. In addition to resident specimens, migratory or wandering specimens from other parts of the continent also come to Romania in winter.

A059 *Aythya ferina* – Pochard

In Romania, it is a relatively common nesting species in areas with optimal habitat, being found in Dobrogea, Muntenia, Oltenia, Banat, Moldova and Transylvania. In winter, important groups are located in the Delta, on the Danube and on the courses and lakes bordering the major rivers in the country (Olt, Siret, Prut, etc.).

A061 *Aythya fuligula* - Tufted Duck

In Romania, the Tufted Duck is a winter guest, relatively rare, having a regular appearance especially on Valea Oltului Inferior, the Siret and Prut rivers, the Danube and Danube Delta and on the Black Sea coast. In Romania, according to the latest published data, a number of 100-600 specimens winter. During winter it can be found in a wide variety of wetlands as long as they are not frozen: fresh or brackish natural lakes, lagoons, seawater, fish ponds, reservoirs or large rivers, in areas where water does not have a high flow rate. Very gregarious species outside the nesting season. In Romania it can be registered especially between October and March.

A087 *Buteo buteo* – Buzzard

The population of Romania is estimated at 20,000-50,000 pairs and is considered stable.

A144 *Calidris alba* – Sanderling

It is a rather rare bird inside the Carpathian chain, more common in the south, east and especially Dobrogea. It appears during our autumn and migrates further south. It returns in the spring to the nesting places located in the north of the Arctic Circle, in the tundra of Greenland and Spitzberg.

A147 *Calidris ferruginea* - Curlew sandpiper

In Romania it is a bird of passage found especially on the coast and near the fresh waters of Dobrogea, coming from the Eurasian tundra, where it nests. Some specimens can be seen over the summer, but they do not hatch in Romania. Small flocks remain on the Romanian coast in winter as well.

A145 *Calidris minuta* - Little Stint

In Romania, it appears only during migration, especially in Dobrogea, in different aquatic habitats, such as the marshy shores of large lakes, the sandy shores of the Danube Delta, along canals and in brackish water ponds.

A146 *Calidris temminckii* - Temminck's stint

In Romania they can be seen during migration, autumn and spring.

A366 *Carduelis cannabina* – Linnet

In Romania, the species is present both during the nesting period and during the winter. In Romania, the number of nesting pairs was estimated at 200,000-500,000 pairs. The Linnet is found in the temperate zone of the western Palearctic and descends to the Mediterranean and steppe areas.

A364 *Carduelis carduelis* - European goldfinch

In Romania it is sedentary, but the number of individuals increases in winter with the arrival of northern populations. In Romania the number was estimated at 750,000-1,500,000 nesting

pairs. The species prefers both open areas and forests, being present near human settlements, in gardens, orchards or parks, where it can find food in abundance.

A363 *Carduelis chloris* - European greenfinch

The population of the species in Romania is important at European level and is estimated at 300,000-600,000 nesting pairs. It is a fairly common bird in open regions with trees and bushes, in gardens and parks, forest edges, clumps of trees, but also inside localities.

A365 *Carduelis spinus* - Eurasian siskin

In Romania it is a sedentary species and a winter guest, the native population being enriched during the winter with specimens coming from the north. In Romania, it is estimated that they would nest a number of 1,000-10,000 pairs. It nests in areas with boreal or temperate climates, on forested land with coniferous or mixed forests.

A288 *Cettia cetti* - Cetti's warbler

In Romania, it appears in the northwestern part of Depresiunea Transilvaniei. The population of Romania is estimated at 20-80 nesting pairs. The species can be found mainly in swampy areas of the plain covered with reeds and scattered shrubs (rarely in uniform reeds) of willow (*Salix sp.*), Thorn (*Rubus sp.*) or blackthorn (*Prunus spinosa*).

A136 *Charadrius dubius* - Little ringed plover

In Romania, the nesting population of this species is between 3,000 and 6,000 breeding pairs. Coastal species, it can be found on wide and sandy shores, on the shores of slowly flowing waters or on the shores of lakes, but also in swamps, especially during migration.

A137 *Charadrius hiaticula* - Common ringed plover

It does not nest in Romania, but appears during the migration periods in spring and autumn. It can sometimes be seen in winter, when wetlands are not frozen. During migration, it is found in Romania on the edge of aquatic habitats (lakes, river banks), where it finds suitable areas for feeding: muddy areas with shallow water.

A373 *Coccothraustes coccothraustes* – Hawfinch

It nests in the western Palearctic, especially in the plains and hills, in some northern areas, in the mediterranean area, steppe, continental area and less in the ocean.

A207 *Columba oenas* - Stock Dove

In Romania it is a widespread species in deciduous forests, from plains to mountains. In milder winters, some specimens remain in Romania in the southern part of the Carpathians, and specimens from northern Europe also come to winter there. In Romania, it is found in the Delta up to about 1,200 m altitude, especially in oak forests and beech forests, but also in mixed forests, if they have hollow beeches or hollows left by woodpeckers. It can also populate isolated clumps of trees that are surrounded by crops, cliffs, buildings, etc., but also willow meadows on watercourses.

A208 *Columba palumbus* - Common Woodpigeon

In Romania it is a species of passage, leaving in October-November and returning in February-March.

A113 *Coturnix coturnix* – Common Quail

For Romania, the nesting population is estimated at 575,000-1,150,000 nesting pairs. The species is found in the hilly and plain regions, in the dense pasture vegetation, in the bushes on the river banks and in the fields cultivated especially with cereals or legumes.

A212 *Cuculus canorus* - Common Cuckoo

In Romania, the nesting population consists of 300,000-600,000 nesting pairs. The habitat of the Common Cuckoo is very wide, this species can be found in deciduous forests, groves on the shores of running waters, sea coast or on the outskirts of cities.

A036 *Cygnus olor* - Mute Swan

The distribution area generally includes the south and west of the Palearctic, including the largest nesting population. Between 5,000 and 16,000 specimens winter in Romania. The species prefers wet, large areas with rich emergent vegetation, reeds, but also lakes with large areas, or ponds, puddles in river meadows, dead arms of rivers, etc.

A253 *Delichon urbica* - House martin

For Romania, the nesting population is estimated at 400,000-1,300,000 nesting pairs. They are grouped in flocks, populating the cities with stone constructions; they can often be seen on power cords. In the wild, the House martin usually nests in caves where light can enter or in cracks in sedimentary rocks, most often on the banks of mountain rivers.

A269 *Erithacus rubecula* - European robin

In Romania, the European robin is common throughout the country, from the plains to the mountainous areas. The nesting population of the species in Europe is very large, being estimated at 43,000,000-83,000,000 pairs, which represents 75-94% of the global population. In Romania, the nesting population of the species is estimated at 1,854,000-2,670,000 pairs and is considered stable.

A099 *Falco subbuteo* - Eurasian hobby

In Romania, the nesting population is estimated at 5,000-12,000 pairs. It lives in open, low-lying areas with clumps of trees and vegetation, often near water.

A096 *Falco tinnunculus* - Common kestrel

In Romania it is widespread throughout the country, and depending on the conditions of the year, the populations may be sedentary or partially migratory. In Romania, along with the Buzzard, it is the most common diurnal bird of prey, nesting in almost all types of habitats, except for closed forests and regions completely devoid of trees.

A359 *Fringilla coelebs* - Common chaffinch

In Romania it is spread from the lowest lands of Dobrogea, in the willow forests of the Danube Delta, climbing up to the juniper areas in the mountain area.

A244 *Galerida cristata* - Crested lark

In Romania it nests all over the country, except for the high mountains. The nesting population in Europe is very large (3,600,000-7,600,000 pairs). It suffered a moderate decline in the 1970s and 1990s, but this decline was offset by an increase in numbers in the southeastern part of the continent. In Romania, the nesting population is estimated at 200,000-400,000 pairs and is growing. It is a typical species of dry plains and arable lands, initially occupying only semi-desert and steppe xeric areas; lately it seems to have colonized the landscapes altered by man.

A153 *Gallinago gallinago* - Common snipe

The nesting population in Romania is small and estimated at 30-50 pairs. It nests in swamps and wetlands, often on the edge of lakes and rivers.

A135 *Glareola pratincola* - Collared pratincole

In Romania, the estimated population is 450-800 nesting pairs, and during migration the group is estimated to be between 800 and 4,000 individuals. The Collared pratincole is a species characteristic of open, salty, sandy areas with little vegetation, located near lagoons.

A299 *Hippolais icterina* - Icterine Warbler

In Romania, the population has been estimated at 15,000-30,000 nesting pairs and is stable. In Europe, it prefers plains and river valleys and is found in oak or mixed forests, in alignments of trees and shrubs, gardens, orchards or in local parks. It likes sunny and humid places. In Romania, the species is widespread in the plains, especially in gardens and deciduous forests,

which have rich undergrowth, but also in mixed forests, showing a preference for the proximity of water.

A251 *Hirundo rustica* - Barn swallow

In Romania it is present especially in and near localities, its distribution being quite uniform throughout the country. The numbers in Romania are estimated to be between 500,000 and 1,000,000 pairs. The swallow is one of the most common nesting species in localities. Its appearance is largely dependent on the breeding of domestic animals. They usually bypass large forests and very dry areas. Probably a long time ago it nested in the mountainous area, the coastal areas with cavities, hollow trees; over time, however, it has adapted to the anthropic environment.

A340 *Lanius excubitor* - Great Grey Shrike

The nesting population in Romania is estimated at between 15,000 and 50,000 pairs. It generally prefers open places, such as pastures and meadows with shrubs and bushes, where higher observation points are present.

A341 *Lanius senator* - Woodchat shrike

In Romania it was found nesting in Dobrogea. In Romania, the nesting population of the species is small, estimated to be between 100 and 400 pairs. The Woodchat shrike is characteristic of semi-open areas with isolated shrubs and trees.

A459 *Larus cachinnans* - Caspian gull

In Romania it nests in the Dobrogea region and in the Danube Delta. In Romania, the nesting population is 2,000-4,000 pairs, and between 25,000 and 70,000 specimens can be seen during the passage. Also, the territory of the country is a wintering place for 10,000-16,000 specimens. It nests in the area of lakes surrounded by extensive reedbeds in the steppe and semi-desert regions, on accumulation lakes, rivers and on islands of rivers with short vegetation with grass and bushes.

A182 *Larus canus* - Common gull

In Romania it appears only during the winter on the coast, in Dobrogea and along the Danube.

A183 *Larus fuscus* - Lesser Black-backed Gull

In Romania it appears only in winter on the shores of the Black Sea. The population that winters in Romania is estimated at 50-100 individuals. The species nests on coastal slopes, sand dunes, cliffs, rocky islands near the coast, salty swamps and inland habitats, such as the edges of lakes and islands on lakes and rivers.

A179 *Larus ridibundus* - Black-headed Gull

In Romania there are resident populations along the Danube, in the Delta, in Dobrogea, in the plains of Moldova, in Depresiunea Transilvaniei and in the plains in the western part of the country.

A150 *Limicola falcinellus* - Broad-billed sandpiper

Bird of passage from the fauna of Romania, with transitions in spring and at the end of summer. It prefers the swampy places, with a lot of mud and water, from where it collects food, which consists of weeds, insects, etc.

A156 *Limosa limosa* - Black-tailed godwit

In Romania, the nesting population is estimated to be between 40 and 80 pairs, and in the passage, flocks between 2,000 and 10,000 individuals can pass through Romania. Preferred habitats during nesting are pastures with tall grass and soft soil, especially grasslands, hayfields, wet meadows, grassy swamps and lake edges.

A292 *Locustella luscinioides* - Savi's warbler

In Romania, the species is distributed throughout the country, except in mountainous areas. The nesting population in Europe is large (530,000-800,000 pairs) and was stable in the 1970s and

1990s. Although groups have declined in a few marginal populations, key populations (especially in Romania) have remained stable over the following decade, so global numbers have remained stable. In Romania, the nesting population is estimated at 40,000-60,000 pairs. It nests in reeds, on swampy meadows with rushes, in sedges, willows, and on the shores of lakes, usually in plain areas, up to a height of 360 m in Europe, but also reaches 1,200 m in Kazakhstan.

A271 *Luscinia megarhynchos* - Common nightingale

In Romania, the species is more common in the hilly areas of Moldova, Depresiunea Transilvaniei and in the meadows along the lower Danube sector. The nesting population in Romania is estimated at 800,000-1,600,000 breeding pairs, being important at European level. The Common nightingale lives in forests with a rich layer of undergrowth, in parks, meadows and bushes, often near wetlands, but also in arid areas with dense bushes. It is very common in man-made habitats, such as orchards, gardens, and local parks.

A230 *Merops apiaster* - European bee-eater

In Romania it is spread all over the country except the Carpathians. The numbers in Romania were estimated at 200,000-400,000 nesting pairs. It uses habitats with sunny, warm, open landscapes, such as pastures and arable land with isolated trees, protected valleys, plains, bushy riverbanks, sunny slopes and meadows.

A383 *Miliaria calandra* - Corn Bunting

In Romania, the nesting population is estimated to be between 1,300,000 and 2,600,000 pairs, being one of the largest European populations. The Corn Bunting is a species found mainly in open fields, with bushes or trees, preferring agricultural land, especially pastures and cereal fields.

A262 *Motacilla alba* - White wagtail

It nests in Romania all over the country, and the populations in the south of the country are resident. The numbers in Romania are estimated at 350,000-700,000 nesting pairs. It is a highly adaptable species, occupying territories in a variety of habitats near water, such as lakes, rivers, streams, canals, estuaries and sea shores. It can be found even further from the water, in localities, on animal farms, roads, airfields, in parks, gardens or in other places where it finds uncovered soil and short grass.

A260 *Motacilla flava* - Western yellow wagtail

In Romania it nests all over the country except the Carpathians. It lives in open habitats, such as pastures, hayfields, arable land, swamps, pastures near water or sewage treatment plants; it also appears in deforested areas, spread over the northern area. It is often seen feeding in the shallow vegetation of river banks and other wetlands, but is also common in xeric areas.

A319 *Muscicapa striata* - Spotted flycatcher

In Romania it is present all over the country, but in relatively low densities, being found both in the plain and hill areas, as well as in the mountain regions. The Spotted flycatcher prefers river banks, rare oak and sessile oak forests, even beeches, but is also found in parks, gardens, forest areas or raspberry areas. It needs, in all these habitats, meadows interspersed with forest habitats.

A058 *Netta rufina* - Red-crested pochard

In Romania it is a nesting species, especially in the Danube Delta and in the Razelm Sinoe complex. In winter, large numbers are stationed in the Danube Delta. Small numbers are regularly recorded on the course and on the lakes bordering the Danube and on the lower course of the river Olt. The population in the country was estimated at 500-2,500 nesting pairs, its trend being considered to be decreasing. In the country between 7,000 and 15,000 specimens winter. The species can be found in a wide variety of wetlands. It prefers sweet lakes with the shores invaded by important areas of emerging vegetation, marshes (reeds and rushes). In Romania it is a species that, although rare, can be found all year round. It is more common in Dobrogea.

A160 *Numenius arquata* - Eurasian curlew

The nesting population in Romania is very small and estimated to be a maximum of 10 pairs. During the migration, the large group numbers in Romania are estimated to be between 8,000 and 15,000 individuals. It lives in wetlands including sweet or salty swamps, rocky beaches with ponds, estuaries, sandy shores and floodplain meadows. It generally prefers lakes and swamps for nesting and winters in coastal areas.

A435 *Oenanthe isabellina* - Isabelline Wheatear

In recent years there has been an expansion of the species to the northwest, and it can be found in Romania, in the Dobrogea area. In Romania, the population was estimated at 3,500-15,000 nesting pairs, with an upward trend. The specific habitat is represented by steppe and semi-desert, with large areas, located in the warm and arid climate, up to an altitude of 3,500 m.

A277 *Oenanthe oenanthe* - Northern wheatear

In Romania, the population was estimated at 220,000-440,000 nesting pairs, with an upward trend. Due to this wide distribution, but also to the very large number of birds, it is not an endangered species, although there has been a slight decline since 1980. Preferred habitats are open regions, such as pastures, clear lands and rocky expanses.

A337 *Oriolus oriolus* - Eurasian golden oriole

The population in Romania is estimated to be between 130,000 and 300,000 nesting pairs. In Europe, the Eurasian golden oriole nests in a variety of habitats, but prefers riparian forests, open deciduous forests, orchards or even larger gardens.

A214 *Otus scops* - Eurasian scops owl

The population in Romania is estimated to be between 8,000 and 20,000 pairs. It nests in lowland and arid areas of the plains and hills, at lower altitudes.

A017 *Phalacrocorax carbo* - Great cormorant

In Romania, the species is partially migratory, wintering mainly on stagnant, inland, unfrozen waters or even on large rivers, and in summer it can be observed on the surface of the water in most aquatic habitats (for example, in fisheries, lakes accumulation, along the Danube, in the Razelm-Sinoe lagoon complex, Danube Delta, on larger rivers with calm water, etc.).

A273 *Phoenicurus ochruros* - Black redstart

Its preferred habitats, however, are the open lands and slopes, where rocks are present. In Romania it is found wherever there are favorite habitats for nesting, from the plains to the alpine hollows.

A141 *Pluvialis squatarola* - Black-bellied Plover

In Romania the species is often observed in the passage, rarely wintering in the Dobrogea region.

A005 *Podiceps cristatus* - Great crested grebe

In Romania the species is partially migratory, wintering mainly on stagnant, unfrozen inland waters or even on large rivers, and in summer it can be seen on the surface of the water in most aquatic habitats (fisheries, reservoirs, Danube, Razelm-Sinoe lagoon complex, Danube Delta, rivers with calm water, etc.).

A006 *Podiceps grisegena* - Red-necked grebe

In Romania it is a summer guest, nesting mainly on inland stagnant waters or even on puddles formed along rivers; in winter it can be observed in coastal areas and on large accumulation lakes (Razelm-Sinoe lagoon complex, lakes in the Danube Delta, etc.).

A008 *Podiceps nigricollis* - Black-necked grebe

In Romania, the species is a summer guest, nesting mainly on inland stagnant waters or even on puddles formed along rivers, and in winter it can be observed on the surface of water in coastal areas and on large surface accumulation lakes (Razelm-Sinoe lagoon complex, Danube Delta, etc.).

A336 *Remiz pendulinus* - Eurasian Penduline-Tit

In Romania, the nesting population is estimated to be between 16,300 and 29,600 pairs. The Eurasian Penduline-Tit is found in the areas with reeds present near lakes, rivers, estuaries and swamps.

A249 *Riparia riparia* - Sand martin

In Romania, the nesting population is estimated at 45,000-90,000 pairs, with more significant populations being found in Ukraine (over 750,000 pairs) and Russia (over 3,000,000 pairs). It can be found in many types of habitat, including farms, pastures and swamps, usually near rivers and lakes.

A275 *Saxicola rubetra* – Whinchat

Romania has a significant population of Whinchat, estimated at 240,000-480,000 nesting pairs. In Romania it is found all over the country, where there are specific habitats, represented by waterfronts, crops bordered by thorny bushes, forest edges, forest lines, wasteland, uncultivated areas, mowed land and plowed areas bordered by bushes or rare trees.

A276 *Saxicola torquatus* - African stonechat

It populates the plains and areas with shrubs and small vegetation.

A210 *Streptopelia turtur* - European Turtle-dove

The number in Romania is estimated at 120,000-300,000 pairs, being in numerical increase. The species can be found from low altitudes, starting at 300 m, where it nests in deciduous forests, to mountainous areas, at over 1,800 m, where it nests in coniferous forests. However, it prefers hill and plain forests near agricultural land. It is found in deciduous forests with tall trees and undergrowth, in forest lines or in various places that have old trees.

A351 *Sturnus vulgaris* - Common starling

In Romania, the number was estimated at 1,500,000 to 3,000,000 nesting pairs. Common starlings prefer urban or suburban anthropogenic areas, where artificial structures and trees provide them with nesting places. Outside the localities, they prefer open forests with old, hollow trees.

A311 *Sylvia atricapilla* - Eurasian blackcap

It is a migratory species in the cold areas of central and northern Europe and sedentary in the western and southern part of the European continent. In Romania, the number of Eurasian blackcaps is estimated at 2,150,000–4,300,000 pairs, with the largest population being in Russia. During nesting, the Eurasian blackcap can be found in forest habitats, being characteristic of deciduous forests, but during this period it can also be found in localities, where there are orchards, parks or gardens rich in trees and shrubs.

A310 *Sylvia Borin* - Garden warbler

In Romania, the nesting population is estimated to be between 200,000 and 400,000 pairs. The habitat characteristic of the breeding season is open areas with dense bushes and forest edges.

A309 *Sylvia communis* - Common Whitethroat

In Romania, the nesting population is between 1,000,000 and 3,000,000 pairs. Common Whitethroat is a bird characteristic of low areas, but in some countries it can be found at higher altitudes, the extreme being in the Caucasus mountains (Muntii Caucaz), where it reaches up to 3,200 m.

A004 *Tachybaptus ruficollis* - Little grebe

In Romania, it is a summer guest that rarely stays during the winter, standing mainly on inland stagnant waters, not frozen, or even near the shores of the Black Sea. It can also be seen in fish farms, on accumulation lakes, on the Danube, in the Razelm-Sinoe lagoon complex, on the Danube Delta, on rivers with calm water, etc.

A048 *Tadorna tadorna* - Common shelduck

In Romania it can be found mainly in the aquatic areas of the eastern part of the country (Dobrogea and the east of Câmpia Română). It sometimes appears in the spring in the south of Oltenia and can be incidentally seen in aquatic habitats in the rest of the country.

A161 *Tringa erythropus* - Spotted redshank

In Romania it is present throughout the country (except in high areas) during periods of migration, more frequent and in larger numbers outside the Carpathian arc. It does not nest in Romania. It is present only during the migration periods in spring and autumn.

A164 *Tringa nebularia* - Common greenshank

In Romania it is present throughout the country during migration periods. It does not nest in Romania. It is present only during the migration periods in spring and autumn.

A165 *Tringa ochropus* - Green sandpiper

In Romania, the nesting population is estimated at a maximum of 100 nesting pairs. During the nesting season, it prefers wetlands in pine, spruce or alder forests, which have swamps and many fallen dead trees, usually in the vicinity of rivers, streams, swamps, ponds or lakes.

A163 *Tringa stagnatilis*- Marsh sandpiper

In Romania, the nesting population is estimated at about 20-50 pairs, and during the passage Romania is transited by about 500-1,500 individuals. During nesting, the species inhabits humid, warm, continental areas, from the steppe to the boreal zone. It prefers shallow areas with fresh or brackish water, shallow, grassy or marshy edges of lakes, flooded meadows and occasionally salt lakes.

A162 *Tringa totanus*- Common Redshank

In Romania, the species has an estimated nesting population of 800–2,000 pairs, and during the passage the numbers increase, being between 5,000 and 15,000 individuals. In the nesting season, it prefers swampy coastal areas, wet meadows and grassy swamps.

A286 *Turdus iliacus* – Redwing

It is a common species in Romania, preferring to nest in birches or mixed forests, shrubs, forest edges, river courses and the edges and floodplains of lakes. In winter it is found in open forests, tree fences, fields, orchards, parks and gardens.

A283 *Turdus merula* - Common blackbird

In Romania it is a common species in parks, gardens and forests, regardless of altitude. The nesting population in Romania has been estimated at 2,150,000-4,300,000 pairs and has an upward trend. Blackbird is the best known species of thrush, found in both urban parks and mountain forests. The habitats in which it is found are very diverse, from dense forests to pastures, various crops, some wetlands, most urban areas.

A285 *Turdus philomelos* - Song thrush

The population in Romania is estimated at 850,000-1,700,000 nesting pairs. The preferred habitat of the song thrush is deciduous and coniferous forests with developed subshrubs in which the favorite food, which is invertebrates, abounds. It has recently adapted to urban habitats, plains turned into arable land, gardens and even parks; the presence of high densities of snails and earthworms, the favorite food of the song thrush, favors the appearance of this species in such places.

A284 *Turdus pilaris* – Fieldfare

It nests at the edge of forests, groves, various plantations, parks and gardens. In Romania, the species nests in Transylvania and locally in Moldova, in hilly and mountainous regions.

A287 *Turdus viscivorus* - Mistle thrush

The Mistle thrush prefers mountainous regions where it is found at medium altitudes, between 800 and 1,000 m. Avoids dense forests, but also deforested areas or with very rare trees, large areas devoid of vegetation or wet habitats.

A232 *Upupa epops* - Hoopoe

In Romania the species has a homogeneous distribution, avoiding regions with relatively extreme altitudes. In Romania, the nesting population is estimated to be between 20,000 and 40,000 pairs. It prefers warm and dry places from hilly regions to mountain depressions, where in addition to trees it finds vertical walls or cliffs.

A142 *Vanellus vanellus* - Northern lapwing

In Romania it nests all over the country except the Carpathian area.

3.5 Climate and climate change

The position of the Dobrogea region on the globe and the climate characterized by a lower nebulosity determine values around 130 kcal / cm² / year [19] for the direct solar radiation. This is the genetic factor that determines the variation of the values of all meteorological and climatic parameters of a certain geographical area.

A consequence of the variation of solar radiation is the spatial distribution of the main baric centers that influence the weather in the study area region. Thus, the main baric centers acting on the studied area are: Azores Anticyclone, Icelandic Cyclone, Mediterranean Cyclones, Russian-Siberian Anticyclone, Northern Anticyclones - Greenlandic and Scandinavian, North African Anticyclone and Arab Cyclone [19].

In general, the climate of the South Dobrogea Plateau (Podișul Dobrogei de Sud), where the project site is located, is characterized by average annual temperatures above 11 ° C and with thermal amplitudes resulting from the differences between the average of June (over 23 ° C) and that of January (-2 ° C). Precipitation is low (400 mm per year), with torrential precipitations. All these elements are specific to a temperate-continental climate. The high degree of aridity is also highlighted by the values of the aridity index Emm. de Martonne which has values <20 in the eastern half and >20 in the western half. Therefore, the phenomena of drought and dryness are very frequent and lengthy in the area of the site. [20].

For a more pertinent characterization of the local meteorology specific to the studied area, information from the study elaborated by the National Meteorological Administration (ANM) in 2019 for the Cernavoda Nuclear Power Plant was used. This study was performed based on the data series measured at the Cernavoda, Fetești and Medgidia meteorological stations. Considering the location of the Cernavoda NPP site, the 3 meteorological stations were considered representative for the studied area.

Normal and extreme values of meteorological parameters

Wind (Horizontal air circulation)

The characterization of this meteorological and climatic element is achieved through 2 parameters: i) wind frequency in directions and ii) wind speed in directions.

The regime of ground air circulation in the area of the site is determined in addition to the general circulation of atmospheric masses and local conditions. Thus, the presence of the Danube-Black Sea Canal influences the wind direction because it favors the channeling of air currents along it [15].

As can be seen in Figure 3.5.1, representing the Wind rose at the Cernavoda weather station, the highest frequencies, of almost between 10% and 12%, belong to the winds from the W-SW, S-SE, W and N- NW. The lowest frequencies (<5%) belong to the winds from S-SW, W-NW, N-NE and S. Also, according to the wind rose, speeds above 15 m / s appear with a higher frequency in the case of winds in the N, E-NE, E and S-SE directions. Also in these directions, winds with speeds between 5.1 and 7 m / s have the highest frequency [25].

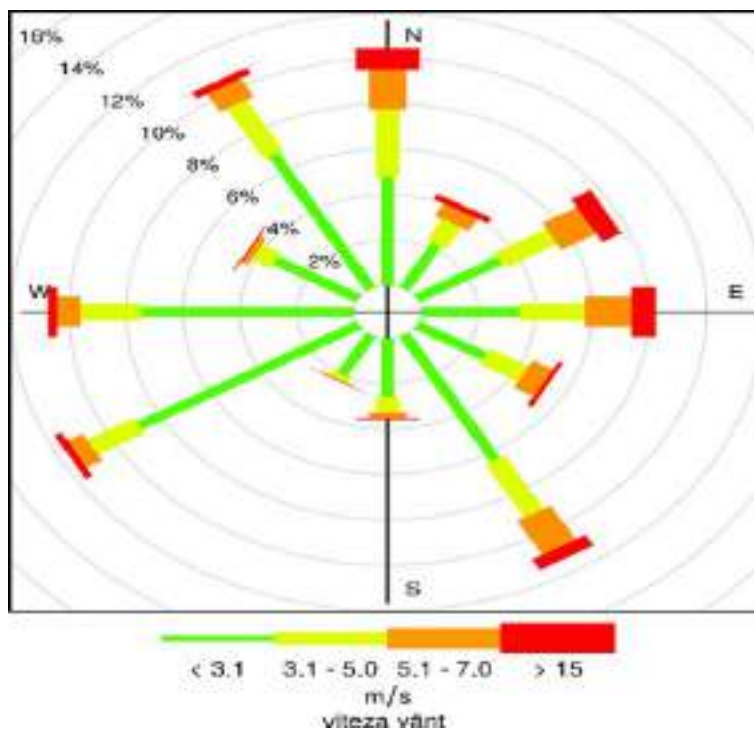

Figure 3.5.1 The Wind rose at Cernavoda meteorological station for the period 2001-2017
 Annual wind frequency on directions and speed thresholds (hourly data) [21]
 *(viteza vant- wind speed)

Figure 3.5.2 shows that in most cases (53.9888%) in which the horizontal movements of the air take place, the wind speed is less than 3.1 m / s. Second most frequent is the speed class between 3.1 and 5 m/s with a frequency of 21.0397%, followed by the class between 5.1 and 7 m / s with a frequency of 10.7869%. The speed class between 5.1 and 15 m / s has a frequency of 4.682%, while speeds above 15 m / s have a very low percent of 0.0156%. Atmospheric calm was recorded in 9.477% of the analyzed period [25].

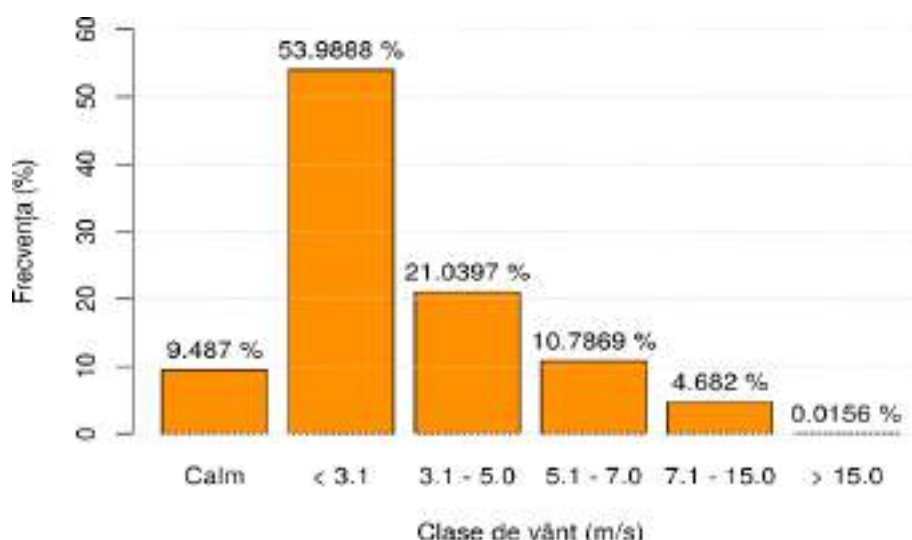

Figure 3.5.2 Distribution of frequencies (in percentages) by average daily wind speed classes, at Cernavoda, in the period 2001-2017 (hourly data) [21]
 *(frecventa- frequency, clase de vant- wind class)

It should be noted that the measurement of these two parameters is carried out within the synoptic network, 10 m from the ground [25].

Maximum wind speeds

Regarding the maximum wind speed, the Cernavoda, Fetești and Medgidia stations were analyzed separately, the probability density been calculated using the distribution of the extreme generalized value of the annual maximum speed histogram [15]. It should be noted that the lack of records in the time series of wind speed records at Cernavoda station from 2002-2017 means that the values of maximum wind speed at Cernavoda station, calculated based on the theoretical distribution of the generalized extreme value, are not relevant for return periods of over 50 years, due to the associated high uncertainties [25].

The absolute maximums recorded at the three reference weather stations are: 30 m / s at Cernavoda, 34 m / s at Fetești and 34 m / s at Medgidia [25].

Figure 3.5.3 shows the distribution of frequencies (in percent) by wind speed classes at gust. Thus, the highest percentage, of 30.16%, belongs to the speed class between 7.1 and 15 m / s [15].

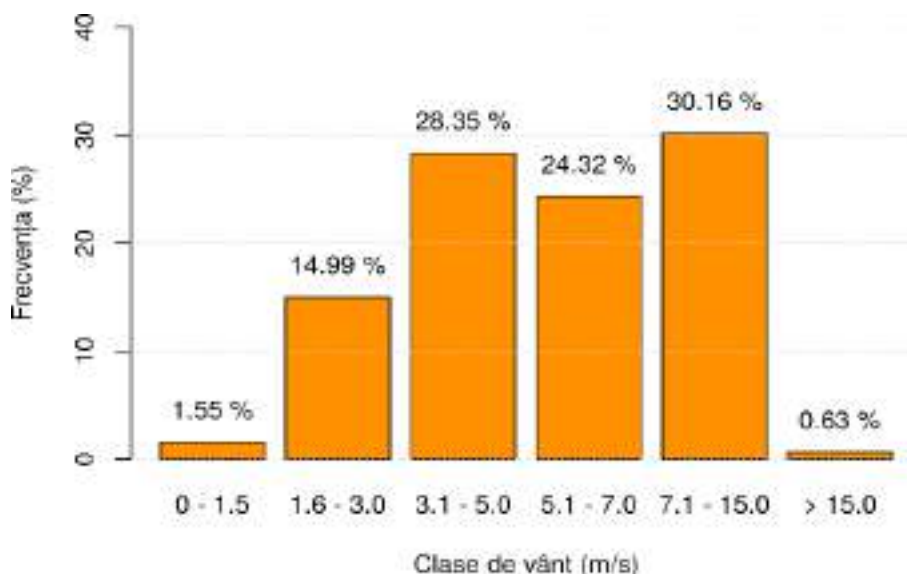

Figure 3.5.3 Frequency distribution (in percentages) by wind speed classes in Cernavoda, in the period 2001-2017 (hourly data) [21]
 *(frecvența- frequency, clase de vânt- wind class)

Table 3.5.1 Maximum wind speed (m / s) with different probabilities, respectively, return periods, in the Cernavoda area [15]

Probabilities (%)	20	10	5	2	1	0.5
Return periods (years)	5	10	20	50	100	200
Maximum speed (m / s) Cernavoda	20.64	24.64	29.76	38.92	48.35	60.69
Maximum speed (m / s) Medgidia	22.84	26.17	29.63	34.55	38.5	42.94
Maximum speed (m / s) Fetești	26.88	29.82	32.39	35.37	37.38	39.20

Strong winds can damage NPP structures and components due to projectiles carried by it [15].

Air temperature

Temperature measurements were made in the meteorological station, 2 m above the ground.

The monthly averages and the annual average air temperature vary slightly from year to year, being characterized by the same evolution during the year. The multiannual average air temperature is around 11 ° C, and is generally higher than in the rest of the country. According to the variation of the average monthly temperatures, it is found that January is the coldest of the year. From this month until July, the temperature has risen steadily, followed by a less pronounced decline at first. At Cernavoda, the average annual amplitude is 23.2 ° C [25].

There are small differences between Cernavoda and the other 2 stations in terms of annual average monthly amplitude [22]: Cernavoda 23.2 ° C; Fetești 23.8 ° C; Medgidia 22.7 ° C. The lower thermal amplitude in Medgidia can be explained by the moderation role of the climate of the Black Sea, which has a weak influence that can be felt in Cernavoda [23].

Regarding the average diurnal amplitude, the maximum is reached during the warmest month and is 10.0 ° C in Cernavoda in July, and the minimum is found during the coldest month and is 3.6 ° C in January.

It is estimated that the monthly temperatures in Cernavoda for the period 2080-2099 according to RCP8.5, compared to the reference period between 1986 and 2005, will mark an increase in temperature between 3.7 ° C and 6.1 ° C [103].

Extreme temperatures

The absolute amplitude, which represents the difference between the absolute maximum and the absolute minimum, is 66.8 ° C at Cernavoda.

In order to describe future developments in climate variables in order to assess climate hazards and estimate future trends (over the next 40 years, 2018-2057, compared to the historical period 1971-2010) for relevant weather extremes and associated uncertainties, global and regional climate models are used with which numerical experiments are performed, in the conditions of scenarios that describe external disturbances (such as changes in the composition of the atmosphere due to the increase in the concentration of greenhouse gases - GHGs). The scenarios used are one of relatively moderate increase in global GHG concentration and another, the worst case one, of strong increase in global GHG concentration. It is worth mentioning that one of the numerical experiments, the worst case one, simulates the maximum daily temperature of 49.5°C in the region of interest (in one month of August of the period 2018-2057) [25]. Table 3.5.2 includes the extreme temperatures for the different return periods or production probabilities.

Table3.5.2 Extreme temperatures [21]

a. Absolute maximum temperature of the air with various probabilities of occurrence (°C)								
Weather station	Return period (years)	1000	100	50	20	10	5	2
	Likelihood of occurrence (%)	0.1	1	2	5	10	20	50
Fetești	Theoretically evaluated values according to the distribution function (°C)	46.5	42.7	41.5	40.0	38.8	37.5	35.6
Medgidia		53.5	47.1	45.1	42.5	40.4	30.3	35.1
b) Absolute minimum temperature of air with various probabilities of occurrence (°C)								
Weather station	Return period (years)	1000	100	50	20	10	5	2
	Likelihood of occurrence (%)	0.1	1	2	5	10	20	50

Fetești	Theoretically evaluated values according to the distribution function (°C)	-35.1	-28.2	-26.1	-23.3	-21.1	-18.4	-15.4
Medgidia		-35.7	-28.1	-25.8	-22.7	-20.3	-17.8	-14.0

Also, according to Figure 3.5.4, it is estimated that for the period 2080-2099, the temperature corresponding to the hottest day will be 4.2°C higher than the hottest day of the period 1986-2005 [103].

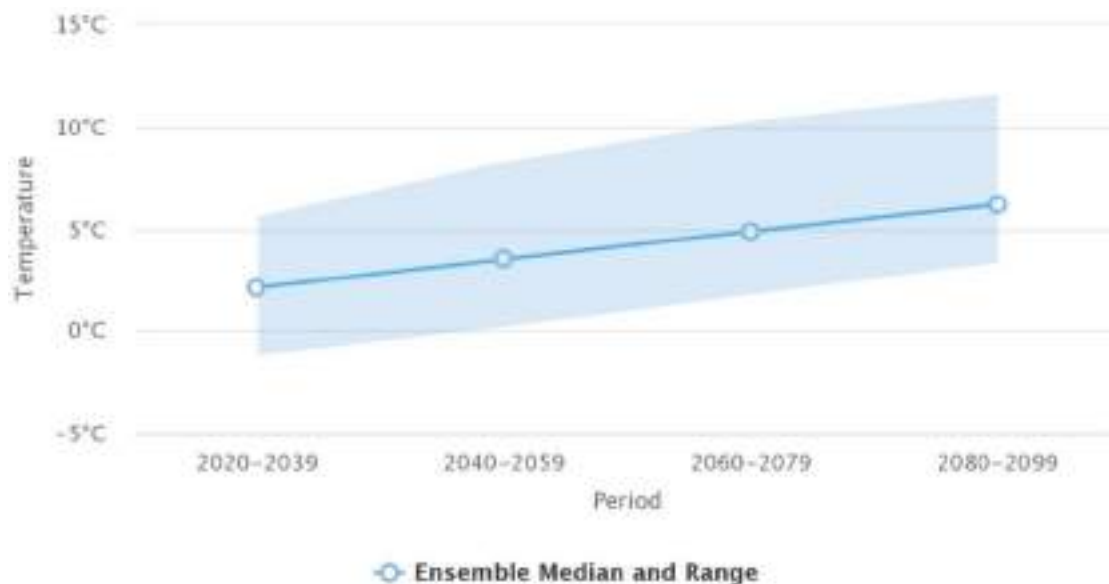

Figure 3.5.4 Forecast changes in maximum daily temperatures of the hottest days in the period 2080-2099 according to RCP8.5 (compared to 1986-2005)

Precipitations

Liquid precipitation (Rain)

The maximum amounts of precipitation recorded in 24 hours (mm), monthly and annually and the date of production at the meteorological stations Cernavoda, Fetești and Medgidia are presented in Table 3.5.3, the maximum values recorded being 155.5 mm at the Cernavoda station, 84.6 mm at Medgidia station and 118.4 mm at Fetești station. The absolute maximum value for the territory of Romania of the amount of precipitation recorded in 24 hours is 224 mm and was recorded in Drobeta Turnu-Severin on July 12, 1999. The maximum absolute amount of precipitation falling in one hour was 47.3 mm at Cernavoda (2010), 97.2 mm in Fetești (1994) and 70.2 mm in Medgidia (1974) [25]

Table 3.5.3 Maximum precipitations in 24 hours (mm), monthly and yearly and date of production at Cernavodă, Fetești and Medgidia weather stations [21]

Station	Parameter	I	II	III	IV	V	VI	VII	VIII	IX	X	XI	XII	Yearly
Cernavodă	Max, abs / 24h	33.2	61.3	38.8	51.3	58.0	98.9	155.5	74.2	61.4	128.2	50.4	36.5	155.5
	Date	30/2005	22/1954	28/2015	12/1987	29/2012	30/2013	28/2017	17/2014	2/1999	4/1945	24/1952	29/2014	28.07.2017
Fetești	Max, abs / 24h	38.9	32.2	45.7	47.4	49.8	64.5	118.4	88.8	95.9	52.6	74.5	42.3	118.4
	Date	17/1959	1/2015	28/2015	14/1997	29/1997	27/1957	16/1994	12/1979	2/1966	15/2005	24/1952	3/1988	July 16, 1994
Medgidia	Max, abs / 24h	25.2	43.7	30.7	47.3	48.0	58.6	74.4	84.6	67.6	75.0	36.6	35.0	84.6
	Date	31/1988	1/2015	28/2015	16/1957	31/1971	30/2013	1/2006	31/1974	27/1974	1/2013	24/1952	22/1966	August 31, 1974

In order to calculate the probabilities and return periods of the 24-hour precipitation quantities, the maximum observed value of the 24-hour precipitation quantity in one year was calculated, for the area that includes Cernavodă NPP, as the maximum value among the values recorded at the 3 stations in the area analyzed, so that the period between 1945 and 2017 was covered with observed data [25]. The maximum amount of precipitation over 24 hours with different probabilities, i.e. return periods, in the Cernavodă area is summarized in Table 3.5.4.

Table 3.5.4 Maximum precipitation in 24 hours with different probabilities, respectively, return periods in the Cernavodă area [21]

Probabilities (%)	20	10	5	2	1	0.5
Return periods (years)	5	10	20	50	100	200
Maximum precipitation amount (mm)	67.82	82.46	99.35	126.66	152.21	183.1

According to the observed data, the maximum amount of precipitation in 24 hours, with a probability of 0.5%, for the area of interest is 183.1 mm. The maximum amount of precipitation for 24 hours (annual value) at Cernavodă station has an observed trend of growth, statistically significant with a confidence level of at least 99%, highlighting increased precipitation intensity. Given that the composite 24-hour maximum precipitation value series for the area including Cernavodă covers a period longer than 50 years, the uncertainties associated with the estimation of probabilities and return periods related to the length of the time series are practically negligible for probabilities less than or equal to 0.5 and return periods less than or equal to 50 years [25]. Comparing the data in Table 3.5.6 and Table 3.5.7 it is observed that the maximum value of precipitation registered in 24 hours at Cernavodă of 155.5 mm corresponds to an anticipated value of about 152.21 mm for a return period of 100 years. The maximum amount of precipitation in 24 hours, annual value, at the Cernavodă meteorological station (1986-2017).

The predicted changes regarding the monthly precipitation in Cernavodă for 2080-2099 according to RCP8.5, compared with the reference from 1986-2005 are presented in figure 3.5.5. The decrease in monthly precipitation is recorded in the range of 0.5 mm - 12 mm (50th percentage value) [103].

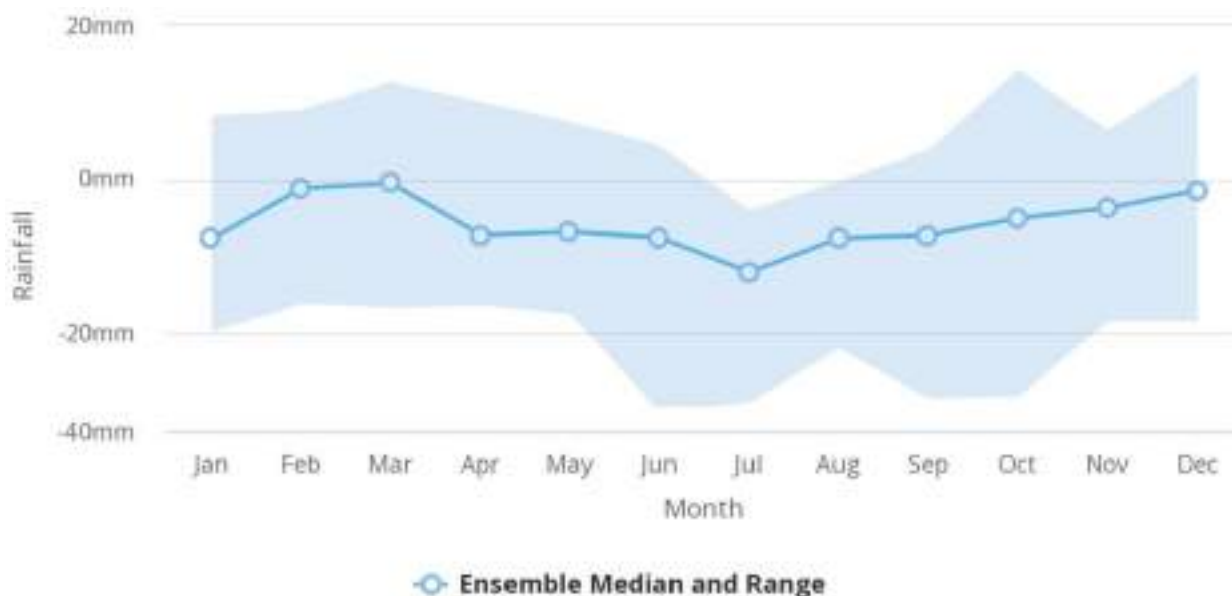

Figure 3.5.5 Expected changes in monthly precipitation in Cernavodă during the period 2080-2099 according to RCP8.5 (compared to 1986-2005)

Source: World Bank Climate Change Information Portal - <https://climateknowledgeportal.worldbank.org/country/romania>

Regarding the events of extreme precipitation, the projections for Cernavodă show small changes in the amount of precipitations that fall during these extreme precipitation events, as shown in

Figure 3.5.6. The indicator shows how much of the amount of precipitation in a given area comes mainly from extreme precipitation events, as opposed to more evenly distributed events. The higher the number, the less the location is dominated by extreme precipitations events. Therefore, the lower the number, the more evenly distributed the precipitations, and the most important rain events are not so exceptional in general. According to Figure 3.5.6 over the period 2080-2099, the rainfall will be approximately evenly distributed in Cernavodă [103].

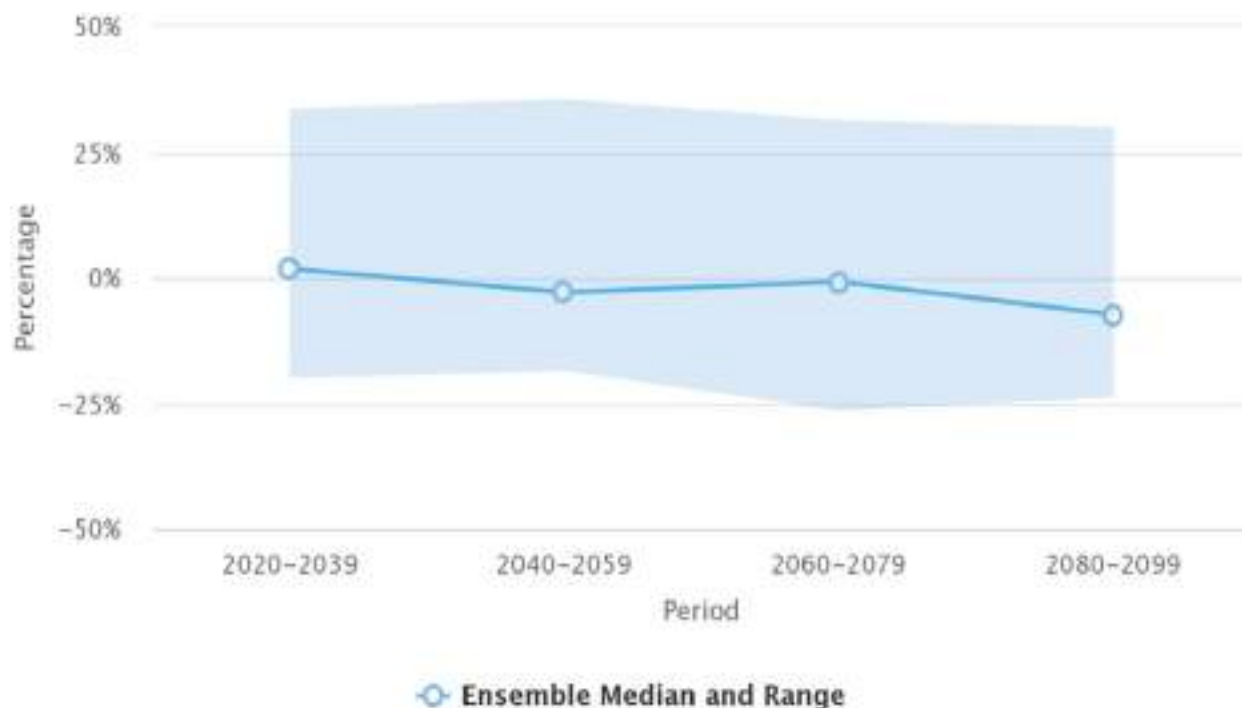

Figure 3.5.6 Expected changes in precipitation from the days when a very large amount of precipitation is recorded in Cernavodă during the period 2080-2099 according to RCP8.5 (compared to the reference period 1986-2005)

Source: World Bank Climate Change Information Portal -<https://climateknowledgeportal.worldbank.org/country/romania>

Solid precipitations (Snow)

The absolute maximum value of the snow layer thickness is 90 cm at Cernavodă station, 96 cm at Fetești station and 11 cm at Medgidia station. Based on the available observation data, the maximum value of the snow layer thickness was calculated, with a probability of 0.5%, which for the area of interest is 159.58 cm. For the calculation of the probabilities and recovery periods of the snow layer thickness, the maximum value observed over one year period was calculated, for the area that includes Cernavodă, as the maximum value between the values recorded at the 3 weather stations in the area analyzed, so the observed data was complete for the period between 1945-2017 [25]. The maximum annual thickness of the snow layer with various production probabilities is presented in table 3.5.5.

Table 3.5.5 The maximum thickness of the snow layer (in cm) with different probabilities, respectively, return periods, in the Cernavodă area (with historical data covering the period 1945-2017, from the 3 weather stations analysed) [21]

Probabilities (%)	20	10	5	2	1	0.5
Return periods (years)	5	10	20	50	100	200
Maximum snow layer thickness (cm)	33.65	46.66	62.92	91.70	121.14	159.58

Extreme weather events

Blizzard

The maximum number of days with blizzard is 6 at Cernavodă station, 9 at Medgidia station and 6 at Fetești station. The definition of the blizzard phenomenon includes two aspects, first, the transport of snow on the ground (below 1.80 m) and second, the transport of snow at height or blizzard itself (over 1.80 m) [25]. The average monthly and annual number of blizzard days is presented in table 3.5.6, whereas table 1 presents the absolute maximum number, monthly and yearly, of blizzard days.

Table 3.5.6 Average monthly and annual number of blizzard days (1961 - 2017) [21]

	I	II	III	N	V	VI	VII	VIII	IX	X	XI	XII	YEARLY
Cernavodă	0.8	0.3	0.1								0.1	0.4	1.7
Fetești	1.2	1.0	0.4	0.0							0.2	0.6	3.4
Medgidia	0.4	0.0	0.2								0.1	0.2	0.9

Table 3.5.7 The absolute maximum number, monthly and annually, of blizzard days (1961 - 2017) [21]

		I	II	III	IV	V	VI -X	XI	XII	YEARLY
Cernavodă	Number of days	3	2	3				1	4	6
	Year of production	2000; 2004; 2005	1996; 2010	1993				1993; 2001	1996	1996
Fetești	Number of days	9	5	4	1			3	4	9
	Year of production	1966	1967; 1969	1993	2003			1981	1961	1966
Medgidia	Number of days	5	1	2				2	5	6
	Year of production	1966	1996; 2015	1962; 1987; 1993				1975	1961	1962

Hail

Analysis of the frequency of hail episodes and the diameter of the hailstone revealed that in the south-eastern part of Romania, both variables are generally below the values of the other regions of the country (Table 3.5.8).

The average duration of the hail episode, calculated from the available data for the period 2001-2017 at Cernavodă station is 14 minutes, the maximum duration is 60 minutes and the minimum is 2 minutes. The thickness of the maximum hailstone diameter, from the records during the operation period, is 20 mm at Cernavodă station, 24 mm at Medgidia station and 24 mm at Fetești station. The maximum value of the hailstone, from the records during the operation period, is 15.7 m / s at Cernavodă station, 18.1 m / s at Medgidia station and 15.7 m / s at Fetești station [25]. The average value of the hailstone speed, from the records during the operation period, is 6.8 m/s at Cernavodă station, 8.1 m / s at Medgidia station and 7.4 m / s at Fetești station. The speed of the hailstone was calculated based on its diameter [26].

Table 3.5.8 Absolute maximum number, monthly and yearly, of hail days [21]

		I	II	III	IV	V	VI	VII	VIII	IX	X	XI	XII	YEARLY
Cernavodă	Number of days		1	2	1	1	2	1		1	1	1		2
	Year of occurrence		1948	1995	1992	1953; 1954; 1987; 2001; 2004	1949	1958; 1991; 1993; 2009; 2012		1952; 1996	1989	1947		1947; 1949; 1992; 1995; 1996; 2009
Fetești	Number of days	1	1	1	1	3	1	1	2	1	1			6
	Year of occurrence	1971	1988	1958; 1970	1951; 1970; 1972; 1973; 1974; 1989; 2001; 2007	1987	1956; 1975; 1977; 1980; 1982; 1985; 1989; 1994	1954; 1963; 1968; 1975; 1976; 1978; 1979; 1994; 1997; 2002	1975	1952; 1988	1975			1975
Medgidia	Number of days				1	2	1	2	1	1	1	1	1	5
	Year of occurrence				1966; 1974; 1983; 1989; 1993; 1995; 2008	2008	1969; 1975; 1977; 1983; 1987; 1988; 1989; 1991; 1992; 2002; 2013; 2015	1976; 1993; 2002; 2010; 2011	1971; 1974; 1980; 1982; 1993; 2003	2005	1993	2010	1980	1993

The potential damage that can be caused by a hailstorm is generally proportional to the size of the hailstone. In addition, other components considered are the hardness of the hailstone, the shape and orientation on the fall trajectory. The latter is also influenced by the speed and direction of the wind during the event. When hail falls in the open field and the damage cannot be measured, the intensity of the phenomenon is related to the size of the hail rather than the damage it could have caused. However, when the damage is not obvious, the lowest category is assigned. The same criterion is used in cases where the damage cannot be quantified: for example, a hailstorm with hailstones the size of chicken eggs can cause H6-H8 damage [25]. If the damage cannot be quantified, hail is transferred to the nearest lower category (H5) according to the grading in table 3.5.9.

Table 3.5.9 International TORRO hail scale [27]

	Category of intensity	diameter (mm) *	Damage caused
H0	Hard Hail	5–9	No damage
H1	Potential damage	10–15	Slight damage to plants, crops
H2	Significant	16–20	Significant damage to fruits, crops, vegetation
H3	Severe	21–30	Severe damage to fruit and crops, damage to glass and plastic structures, marks on paint and wood
H4		31–40	Significant damage to glass structures, damage to vehicles
H5	Destructive	41–50	Destruction of glass structures, damage to tile roofs, significant risk of injury
H6		51–60	Damage to brick walls
H7	Very destructive	61–75	Severe damage to roofs, risk of significant injury
H8		76–90	Severe damage to aircraft structure
H9	Super hailstorms	91–100	Severe damage to infrastructure, risk of severe or fatal injuries to people in the open
H10		> 110	Severe damage to infrastructure, risk of severe or fatal injuries to people in the open

*Approximate range of values, other factors, difficult to quantify directly from the measurements of the hail phenomenon carried out in Romania (eg the number of hailstones per unit area, wind speed), may also affect the severity.

With weather data on average precipitations and average daily temperatures for the last ten years in the interpolated grid data set [28] it was possible to make a multiannual monthly average for the whole area within a radius of 30 km. With the resulted data it was possible to draw up the Walter-Lieth climate diagram (Figure 3.5.7). It is clear from the figure mentioned earlier that from the beginning of June until the second half of September, the phenomenon of dryness manifested (on average), which is materialized by hash marks with orange dots. Shaded areas with blue vertical lines denote wet periods.

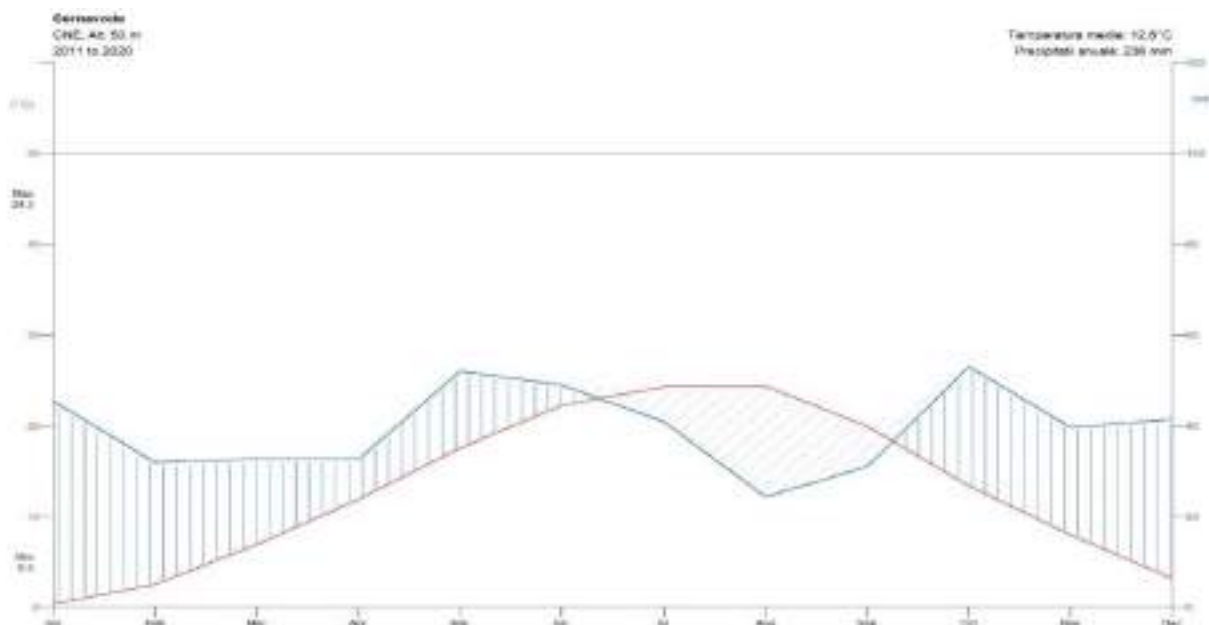

Figure 3.5.7. Walter-Lieth type climate diagram for the period 2011-2020 (multiannual monthly averages)

Lightning

The frequency of this phenomenon is expressed by the average annual and monthly number of days with thunderstorms and by the maximum absolute monthly and annual number of days with thunderstorms. The highest average number of stormy days per month is June. It is 5.6 in Cernavodă, 7.8 in Fetești and 7.9 in Medgidia [25]. The average annual number is 21.8 days in Cernavodă, 29.5 days in Fetești and 30.6 days in Medgidia [29]. Table 3.5.10 shows the maximum number of days with thunderstorms from the 3 representative stations for the studied area.

Table 3.5.10 Absolute maximum monthly and annual number of thunderstorm days [29]

Station		I	II	III	IV	V	VI	VII	VIII	IX	X	XI	XII	ANNUALLY
Cernavodă	Number of days		2	4	5	8	12	11	9	8	3		10	35
	Year of production	2000, 2007, 2010, 2014	2009	2006	2005	2008	1953; 997; 1998	1997; 2010	2004	1996	2005	1952	1954	1954
Fetești	Number of days	2		4	7	14	14		13	10	2			54
	Year of production	1971	1985	1979	2006	1975	1979, 1997	1983	2002	1968	1955; 1960; 1964; 1973; 1982; 1998; 2005; 2007	1957; 1980; 1981; 1997	1995; 997	1979
Medgidia	Number of days	2	2			14					5			51
	Year of production	1953; 2001	1973	2006	1995	2010	1982; 1989; 1997	2010	1975	1996	1960	2010	1973; 1980; 1990; 1997	2010

Tornadoes

According to Figure 3.5.8, tornadoes have the highest frequency in the southeastern part of the country where the project site is located (approx. 1.5 - 2.25 tornadoes per $10^5 \text{ km}^2 / 5 \text{ years}$). Tornadoes occur mainly during the months of May-July, and they occur between 09:00-20:59, with a maximum around 15:00 and 17:00 [30]. So far, tornadoes have been recorded in the area of interest, but ranking their maximum intensity on the Fujita scale (Table 3.5.11) is very difficult. This is caused by the lack of a systematic dataset, sufficiently extended in time. Tornadoes are phenomena characteristic of spatial (several km) and temporal (minutes and tens of minutes) scales that are difficult to observe in a classical meteorological network. Most comments, on the basis of which the studies have been carried out so far [30] are of some observers who happened to be at the place and time of the occurrence of tornadoes [29]. Both the very strong wind and the projectiles carried by it during tornadoes - can damage the structures and components of the Cernavodă NPP [15].

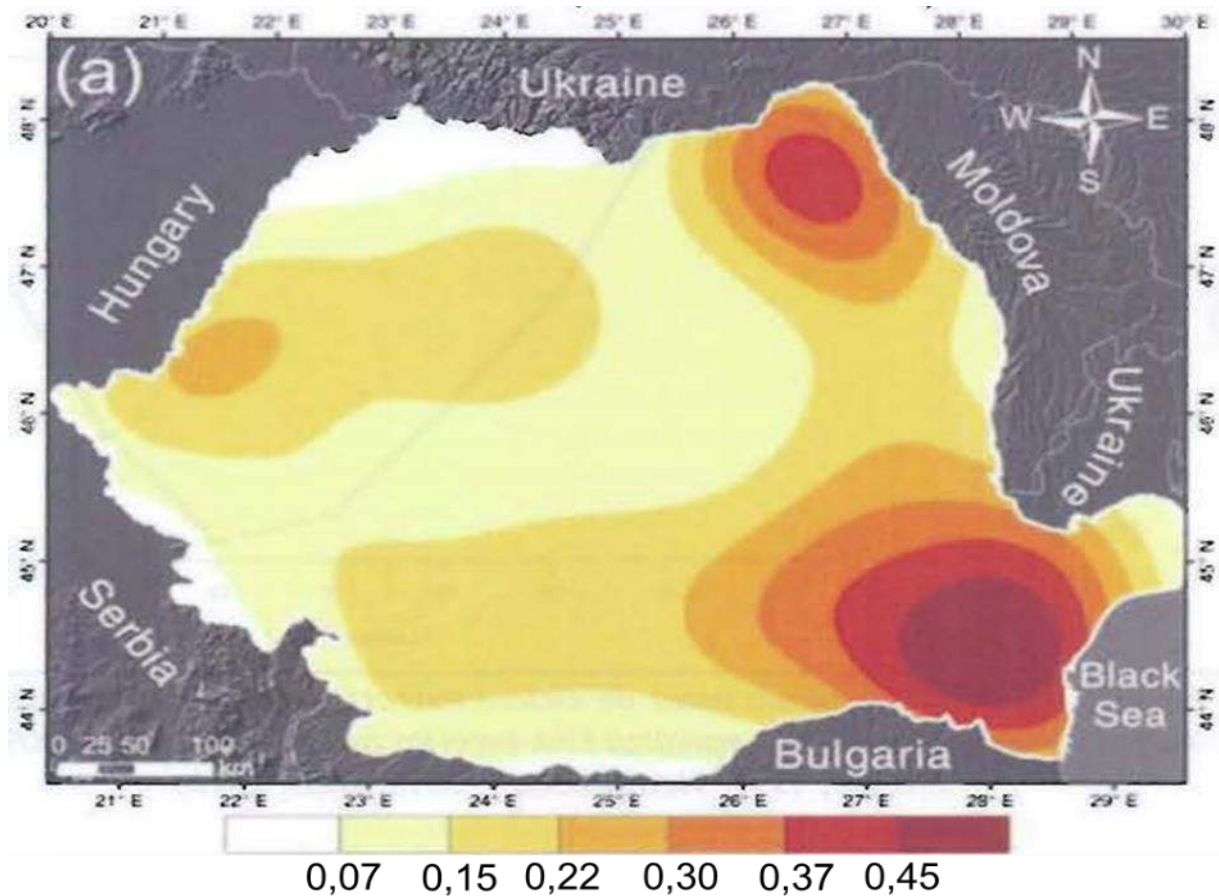

Figure 3.5.8 Spatial distribution of tornadoes in Romania [30]

Table 3.5.11 Fujita scale of tornado intensity and associated effects in Europe [29]

Fujita Scale	Wind speed (km / h)	Effects on average (brick) houses in Europe
F0	64- 116	Almost no destruction
BE	117 - 180	Small and medium damage to the roof
F2	181 - 253	Significant damage to the roof / roof ripped off the house
F3	254 - 332	Ripped roof / collapsed walls
F4	333 - 418	Almost all the walls collapsed
	419 - 512	Destroyed house

3.6 Radioactivity

In the case of nuclear power plants, the main risks to environmental protection are related to radioactive pollution of the environment. In order to limit the internal and external radiation exposure of the population and operating staff, several elements of control of radioactive sources and protection against contamination and exposure to radiation were established within Cernavodă NPP, such as [8]:

- separation of areas where radiation sources are present and controlled access to these spaces;
- the establishment of contamination control systems for the physical separation of the atmosphere between different areas and the use of controlled flow ventilation systems;
- heavy water vapor recovery;
- decontamination of equipment and personnel with adequate facilities and means;
- limiting and monitoring the radioactivity of liquid and gaseous effluents and safe storage of radioactive wastes;
- monitoring of contamination in all areas where radiation sources are present normally or occasionally.

Mathematical model for forecasting doses due to gaseous and liquid emissions during the routine operation of Cernavodă NPP.

From the analysis of the results of the environmental radioactivity monitoring at the Cernavodă NPP, for the environmental factor "air", it emerges that the only radionuclides for which an additional dose to the population can be considered, as a result of gaseous emissions from the plant, are H-3 and C-14.

For these radionuclides, the annual doses that can be received by representatives of the population, established according to the methodology for calculating the derived evacuation limits (LDE) for Cernavodă NPP, were estimated [31].

Doses were calculated by two methods, described below:

- based on the gaseous and liquid emissions (discharges) of the two nuclear units (applied for H-3 and C-14);
- based on concentrations measured in environmental samples by the routine environmental radioactivity monitoring programme at the Cernavodă NPP (it was applied only for H-3).

Method 1 - calculation of doses starting from the gaseous and liquid discharges of U1 and U2

This method is based on the LDE calculation methodology [31]. The method uses the global transfer parameters " f_i " (maximum annual effective unit doses), determined for the members of each critical group and for each evacuation route, according to the LDE calculation methodology. As such, it is a conservative method, leading to overestimation of dose values.

Dose calculation is based on the following formula:

$D_i = f_{ik} * 10^6 * (E_{ik} * 1000/8760/3600)$, where:

- D_i (mSv / year) = annual dose of radionuclide "i"
- f_{ik} (Sv*s/Bq / year) = the maximum effective annual dose for one person in the population, due to a continuous release, at a rate of one Bq / s, of radionuclide i, on the release path k;
- E_{ik} (kBq / year) = annual emission of radionuclide "i" in the evacuation way "k".

The values of the f_{ik} parameters were calculated by Cernavodă NPP and approved by CNCAN [31].

Dose conversion factors for exposure pathways originating in the gaseous emissions are given in the table below.

Table 3.6.1 Dose conversion factors for exposure pathways originating in gaseous emissions

	fi (Sv / an per Bq / s)		
	Inhalation	Ingestion	Total
adult (H-3)	1.96E-13	1.47E-13	3.44E-13
child (H-3)	2.50E-13	1.68E-13	4.18E-13
adult (C-14)	8.72E-12	7.42E-11	8.29E-11
child (C-14)	6.09E-12	8.35E-11	8.95E-11

Similarly, the following table shows the conversion factors established for the assessment of exposure in the case of exposure pathways originating from liquid effluents (Table 3.6.2).

Table 3.6.2 Conversion factors established for exposure assessment in the case of exposure pathways originating in liquid effluents

	fi (Sv / an per Bq / s)		
	Cernavodă	Constanța	Seimeni
H-3 adult	1.77E-13	2.35E-13	8.51E-15
C-14 adult	7.90E-10	7.55E-12	1.65E-11
H-3 child	3.83E-13	3.57E-13	1.53E-14
C-14 child	6.93E-12	7.81E-12	3.05E-13

The emission values used in the calculation are the values of the total annual emissions for each nuclear unit and evacuation way, presented in the report IR-96200-054: "Results of monitoring of environmental factors and the level of radioactivity in the Cernavodă area, period 1996-2020", revision 0.

For gaseous discharges [31] the following were considered as representative of the population: adults and children residing in Cernavodă.

For liquid discharges, the following representative persons from the population were considered:

- Cernavodă - adult, respectively child (evacuation way: Danube - Black Sea Canal);
- Constanța - adult, respectively child (evacuation way: Danube - Black Sea Canal);
- Seimenii Mari - adult, respectively child (evacuation way: Danube).

In terms of routes of exposure, only inhalation, ingestion of food and immersion in water are relevant for H-3 (transfer parameters from atmosphere or water, soil or sediment and immersion into the atmosphere are equal to zero, so the external dose and that received by immersion in the atmosphere are zero). For C-14, the only relevant routes of exposure are inhalation and ingestion of food.

Immersion in water was taken into account only for Seimenii Mari, because in the Danube - Black Sea Canal (CDMN) swimming is not practiced (for Cernavodă and Constanța).

The municipality of Constanța was taken into account only with the dose derived from water ingestion (because approximately 40% of its population is supplied with drinking water from CDMN).

Method 2 - Dose calculation based on concentrations measured in environmental samples

This method is similar to method 1 in that it uses the same transfer parameters as set out in IR-96002-027, but the exposure calculation is based on activity concentrations measured in environmental samples from different environmental compartments and uses only conversion factors linking the doses received through different routes of exposure - to the concentrations of activity in the corresponding environmental compartments.

The method is less conservative than the first and closer to estimating actual effective doses, as it eliminates the more conservative assumptions used to determine transfer parameters that link concentrations in environmental compartments to radioactive discharges from sources.

Effective doses due to tritium emissions are calculated using the following ratios [84]:

$$D[Sv/a] = C[Bq/m^3] \cdot I[m^3/a] \cdot FC \cdot DCF_i[Sv/Bq]$$

Where:

- C H-3 activity concentration in air (Bq / m³)
- I inhalation rate (m³/ a)
- FC occupational factor (fraction of the number of days in the year the person is exposed)
- DCF_i dose conversion factor for inhalation

$$D[Sv/a] = C[Bq/kg] \cdot I_f[kg/a] \cdot DCF[Sv/Bq]$$

Where:

- C (Bq / kg) the concentration of H-3 in the food sample
- I_f (kg / year) the consumption rate of the respective food product
- DCF (Sv / Bq) dose conversion factor for ingestion

In the calculations, the values of the transfer parameters presented in the tables of the Information Report - Derived evacuation limits for Cernavodă NPP IR-96002-027, revision 1, 2015 were used directly. The values of constants I, FC and DCF_i are those given in "Guidelines for Calculating Derived Release Limits for Radioactive Material in Airborne and Liquid Effluents for Normal Operation of Nuclear Facilities CAN / CSA-N288.1-M87" and "Safety Series No. 115, International Basic Safety Standards for Protection against Ionizing Radiation and for the Safety of Radiation Sources, IAEA 1996".

This method calculated the annual effective doses of tritium (hereinafter referred to simply as "effective doses") which may be received by a member of each of the critical groups defined for Cernavodă (adults, children aged 0 to 1 years, respectively) for each year from 2010 to 2020.

No doses have been estimated for the critical groups in Constanța and Seimenii Mari, as they are located further away from the plant than the city of Cernavodă and are characterized by source-atmosphere transfer parameters (atmospheric dispersion factors) with lower values, provided that gas evacuations are the major contributor to the dose.

The routes of exposure relevant to the inhabitants of Cernavodă for tritium are inhalation and ingestion of food (as shown in the description of method 1).

The values of tritium activity concentration in the environmental compartments used in the dose calculation are:

- for the route of inhalation exposure ("air" environmental compartment) - values of the annual average concentrations measured at the monitoring site ADI-08, located in Cernavodă
- for routes of exposure by ingestion of food (environmental compartments: "fruit", "vegetables", "fish", "eggs", "milk", "chicken", "pork", "beef") - the averages between the sampling locations, for the values of the average annual concentrations calculated for each sampling location and each food category.

Table 3.6.3 shows the annual averages of H-3 activity concentration in the representative samples for the environmental compartments affected by the release of radioactive effluents, considered in the evaluation of the effective dose.

Table 3.6.3 Annual averages of H-3 activity concentration in representative samples for impacted environmental compartments

Year	Vegetables (Bq / kg)	Fruit (Bq / kg)	Cereals (Bq / kg)	Meat (Bq / kg)	Milk (Bq / l)	Eggs (Bq / kg)	Fish (Bq / kg)	Water (Bq / l)	Air (Bq / m ³)
2010	12.6	12.44	5.3	6.99	9.84	19.34	6.53	3.88	1.49
2011	8.86	11.39	10.64	2.71	4.44	15.49	2.96	4.23	0.29
2012	6.96	17.5	1.57	4.64	5.83	5.53	5.36	3.22	1.73
2013	4.56	15.35	6.82	2.47	5.64	13.83	5.08	3.03	1.26
2014	11.59	12.63	2.09	3.53	7.7	23.68	5.89	3.29	1.49
2015	4.82	3.51	1.43	3.8	7.88	<1.13	4.27	3.34	0.6
2016	5.88	13.29	0.66	3.28	11.4	5.5	5.26	8.69	0.32
2017	4.51	6.43	0.73	12.58	11.7	53.1	5.53	3.33	0.24
2018	8.48	8.01	0.46	4.79	6.83	5.63	3.23	5.63	0.99
2019	9.57	12.75	1.72	2.09	9.88	16.78	4.06	4.66	1.66
2020	6.73	31.22	0.91	3.21	9.39	11.87	8.33	4.89	0.93

Presentation of data on radioactive emissions, for the last 10 years of operation of Cernavodă NPP, highlighting the contribution of tritium and C-14 to the dose for a representative person in the population.

Table 3.6.4 shows the annual emissions of H-3 and C-14 in the radioactive gas effluents released by Cernavodă NPP and the annual LDE values (established for each nuclear unit).

Table 3.6.4 Annual emissions of H-3 and C-14 in radioactive gas effluents released by Cernavodă NPP and annual LDE values

Year	H-3 (oxide) [kBq]		C-14 (gas) [kBq]	
	Unit 1	Unit 2	Unit 1	Unit 2
2010	2.49E + 11	5.30E + 10	2.17E + 08	3.61E + 08
2011	1.40E + 11	5.90E + 10	1.07E + 08	2.00E + 08
2012	3.01E + 11	6.73E + 10	6.92E + 07	4.02E + 08
2013	2.35E + 11	8.36E + 10	1.09E + 08	3.01E + 08
2014	3.05E + 11	9.95E + 10	8.20E + 07	3.17E + 08
2015	1.44E + 11	1.20E + 11	1.12E + 08	3.63E + 08

Year	H-3 (oxide) [kBq]		C-14 (gas) [kBq]	
	Unit 1	Unit 2	Unit 1	Unit 2
2016	1.75E + 11	1.71E + 11	9.32E + 07	2.39E + 08
2017	1.34E + 11	1.63E + 11	8.64E + 07	3.00E + 08
2018	1.52E + 11	1.26E + 11	1.11E + 08	2.67E + 08
2019	1.82E + 11	1.56E + 11	1.41E + 08	2.84E + 08
2020	1.81E + 11	1.54E + 11	1.56E + 08	1.97E + 08
LDE	3.96E + 12 kBq / unit		5.28E + 09 kBq / unit	

Regarding the emissions of liquid effluents, the record of the annual activities is kept taking into account the release route (cooling water evacuation canal - Seimeni, or Danube-Black Sea Canal). Table 3.6.5 shows the annual activities of H-3 and C-14 released by liquid effluents by Cernavodă NPP, in the period 2010 - 2020.

Table 3.6.5 Annual activity for H-3 and C-14 released by liquid effluents by Cernavodă NPP, in the period 2010 - 2020

Year	H-3 [kBq]		C-14 [kBq]	
	Seimeni	CDMN	Seimeni	CDMN
2010	9.19E + 10	4.09E + 08	3.41E + 06	-
2011	1.48E + 11	-	1.02E + 07	-
2012	1.98E + 12	-	1.14E + 05	-
2013	9.95E + 10	-	-	-
2014	9.46E + 10	2.18E + 08	-	-
2015	2.31E + 11	-	-	-
2016	2.24E + 11	-	-	-
2017	1.59E + 11	-	-	-
2018	1.72E + 11	-	-	-
2019	1.34E + 11	-	-	-
2020	1.89E + 11	-	-	-
LDE	4.92E + 13	1.97E + 12	4.28E + 07	8.94E + 05

Applying method 1, based on the model of calculation of the derived evacuation limits, the annual effective doses were calculated for each radionuclide (hereinafter referred to as "maximum doses") that can be received by a member of the population, for each way of evacuation and each different way of exposure, for the years 2010-2020. The results of these estimates, with respect to exposure due to H-3 releases to gaseous effluents, are presented in Table 3.6.6.

Table 3.6.6 Annual effective doses for H-3 in gaseous effluents

Year	Maximum effective dose (μSv)					
	inhalation - adult	inhalation - child	ingestion - adult	Ingestion - child	total - adult	total - child
2010	1.88	2.39	1.41	1.61	3.29	4.00
2011	1.24	1.58	0.93	1.06	2.17	2.63
2012	2.29	2.92	1.72	1.96	4.01	4.88
2013	1.98	2.52	1.49	1.69	3.47	4.22
2014	2.52	3.20	1.89	2.15	4.40	5.35
2015	1.64	2.09	1.23	1.40	2.87	3.49
2016	2.15	2.74	1.61	1.84	3.77	4.58
2017	1.85	2.35	1.39	1.58	3.23	3.93
2018	1.73	2.20	1.30	1.48	3.03	3.68
2019	2.10	2.68	1.58	1.80	3.68	4.47
2020	2.08	2.65	1.56	1.78	3.65	4.43
Dose constraint for H-3 in gaseous effluents = $52.5\mu\text{Sv}$ (for a nuclear unit, according to CNCAN authorizations)						

Similarly, in table 3.6.7, the values of the maximum annual doses due to the releases of C-14 in the gaseous effluents from Cernavodă NPP, for the period 2010 – 2020 are presented.

Table 3.6.7 Annual effective doses for C-14 in gaseous effluents

Year	Maximum effective dose (μSv)					
	inhalation - adult	inhalation - child	ingestion - adult	Ingestion - child	total - adult	total - child
2010	0.16	0.11	1.36	1.53	1.52	1.64
2011	0.08	0.06	0.72	0.81	0.81	0.87
2012	0.13	0.09	1.11	1.25	1.24	1.34
2013	0.11	0.08	0.96	1.08	1.08	1.16
2014	0.11	0.08	0.94	1.06	1.05	1.13
2015	0.13	0.09	1.12	1.26	1.25	1.35
2016	0.09	0.06	0.78	0.88	0.87	0.94
2017	0.11	0.07	0.91	1.02	1.01	1.10
2018	0.10	0.07	0.89	1.00	0.99	1.07
2019	0.12	0.08	1.00	1.12	1.12	1.21
2020	0.10	0.07	0.83	0.93	0.93	1.00
Dose constraint for C-14 in gaseous effluents = $15.0\mu\text{Sv}$ (for a nuclear unit, according to CNCAN authorizations)						

Table 3.6.8 shows the estimates of the maximum effective doses for the population as a result of H-3 releases in liquid effluents from Cernavodă NPP.

Table 3.6.8 Annual effective doses for H-3 in liquid effluents

Year	Maximum effective dose (μSv)					
	adult			child		
	Cernavodă	Constanța	Seimeni	Cernavodă	Constanța	Seimeni
2010	0.002	0.003	0.025	0.005	0.005	0.045
2011	-	-	0.040	-	-	0.072
2012	-	-	0.533	-	-	0.960
2013	-	-	0.027	-	-	0.048
2014	0.001	0.002	0.026	0.003	0.002	0.046
2015	-	-	0.062	-	-	0.112
2016	-	-	0.061	-	-	0.109
2017	-	-	0.043	-	-	0.077
2018	-	-	0.046	-	-	0.083
2019	-	-	0.036	-	-	0.065
2020	-	-	0.051	-	-	0.092
Dose constraint for H-3 in liquid effluents = 24.25 μSv (for a nuclear unit, according to CNCAN authorizations)						

The maximum effective dose was similarly estimated for the population due to C-14 releases in liquid effluents from Cernavodă NPP (Table 3.6.9).

Table 3.6.9 Annual effective doses for C-14 in liquid effluents

Year	Maximum effective dose (μSv)					
	adult			child		
	Cernavodă	Constanța	Seimeni	Cernavodă	Constanța	Seimeni
2010	-	-	1.78E-03	-	-	3.46E-05
2011	-	-	5.33E-03	-	-	1.03E-04
2012	-	-	5.98E-05	-	-	1.16E-06
2013	-	-	-	-	-	-
2014	-	-	-	-	-	-
2015	-	-	-	-	-	-
2016	-	-	-	-	-	-
2017	-	-	-	-	-	-
2018	-	-	-	-	-	-
2019	-	-	-	-	-	-
2020	-	-	-	-	-	-
Dose constraint for C-14 in liquid effluents = 22.7 nSv (for a nuclear unit, according to CNCAN authorizations)						

By summing the contributions to the maximum effective dose of exposures due to the release of liquid and gaseous effluents, the maximum effective dose was estimated for each category of representative persons in the population, considered in the calculation model used. In the table 3.6.10 the results of these estimates for H-3 emissions are presented.

Table 3.6.10 Estimated results for maximum effective dose of exposure due to release of liquid and gaseous effluents

Year	Maximum effective dose (μSv)					
	adult			child		
	Cernavodă	Constanța	Seimeni	Cernavodă	Constanța	Seimeni
2010	3.292	0.003	0.025	4.005	0.005	0.045
2011	2.168	-	0.040	2.636	-	0.072
2012	4.012	-	0.533	4.878	-	0.960
2013	3.471	-	0.027	4.220	-	0.048
2014	4.408	0.002	0.026	5.361	0.002	0.046
2015	2.876	-	0.062	3.497	-	0.112
2016	3.769	-	0.061	4.583	-	0.109
2017	3.236	-	0.043	3.934	-	0.077
2018	3.029	-	0.046	3.682	-	0.083
2019	3.682	-	0.036	4.477	-	0.065
2020	3.650	-	0.051	4.437	-	0.092

Similarly, the maximum effective dose due to C-14 emitted in the form of liquid and gaseous effluents by Cernavodă NPP during the period 2010-2020 was calculated (Table 3.6.11).

Table 3.6.11 Results calculated for the maximum effective dose due to C-14 issued in the form of liquid and gaseous effluents by Cernavodă NPP, in the period 2010-2020

Year	Maximum effective dose (μSv)					
	adult			child		
	Cernavodă	Constanța	Seimeni	Cernavodă	Constanța	Seimeni
2010	1.519		1.78E-03	1.641		3.46E-05
2011	0.807		5.33E-03	0.872		1.03E-04
2012	1.238		5.98E-05	1.338		1.16E-06
2013	1.078			1.164		
2014	1.049			1.133		
2015	1.248			1.349		
2016	0.873			0.943		
2017	1.016			1.097		
2018	0.993			1.073		
2019	1.117			1.207		
2020	0.928			1.002		

Using the calculation method 2 described above, the actual dose values (in excess compared to the natural background) were estimated for a representative of the population (resident in Cernavodă) as a result of exposure to H-3 from liquid and gaseous effluents released in the environment by Cernavodă NPP (Table 3.6.12).

Table 3.6.12 Additional effective doses calculated for excess against natural background

Year	Additional effective dose (μSv)		
	inhalation	ingestion	total
2010	0.251	0.15	0.401
2011	0.048	0.12	0.168
2012	0.291	0.11	0.401
2013	0.211	0.09	0.301
2014	0.25	0.13	0.38
2015	0.101	0.07	0.171
2016	0.054	0.16	0.214
2017	0.04	0.08	0.12
2018	0.167	0.12	0.287
2019	0.279	0.12	0.399
2020	0.156	0.15	0.306

The analysis of the results presented above shows that the additional effective doses calculated by method 2 are systematically lower than those calculated by method 1, due to the lower degree of conservatism of this method. **Even in the case of maximum effective doses (assessed by method 1), their level is well below the values of the dose constraints associated with radionuclides and their release ways established in the authorization process.**

3.7 Noise

The results of noise measurements at the edge border of the Cernavodă NPP site were used to characterize the initial state [8]. These measurements were compared with the noise levels calculated for the Cernavodă NPP site border. For these calculations, the noise sources were taken from 2017 Level 2 Environmental Balance for the Cernavodă NPP [38].

Table 3.7.1 Comparison of measured and estimated values, dB(A)

Measuring Point	Measured Sound Pressure Level	Sound Pressure Level Calculated
Cernavodă NPP		
1p	< 45,0	42,8
2p	< 45,0	41,5
3p	< 45,0	38,7
4p	< 45,0	37,9
5p	< 45,0	39
6p	< 45,0	39,7
7p	50	54,5
8p	62,5	58,7
9p	62,5	64,5
10p	45,0	58
11p	60,2	62,6
12p	49,6	54,9
13p	<45,0	42,4
14p	<45,0	46,5

The measured and calculated values were used to draw up noise maps (Figure 3.7.1 and 3.7.2), illustrating the current situation of noise levels at the Cernavodă NPP boundary.



Figure 3.7.1 Noise map for normal operation



Figure 3.7.2 - 3D noise map for normal operation

In addition, in order to describe the existing situation in the area of the Cernavodă NPP site, on-site measurements were also carried out. Noise sources were measured with a Bruel&Kjaer 2250 sound level meter, class 1, calibrated and metrologically verified, and for the acoustic modelling a specialized software for noise mapping, Predictor - LimA v. 2021, was used.

For this, the following steps were performed:

- Noise level measurement;
- Identification of noise generating sources, to clarify the periods of operation at maximum capacity on the premises;
- Realization of a calculation model of the acoustic zoning (emission and dispersion of sound waves).

Noise measurements were carried out from 23 June to 4 August 2021 by Enviro Consult SRL in accordance with ISO 1996-2: 2017 at representative locations of noise sensitive receptors potentially affected by the construction and operational phases of the project. Noise measurements were also carried out near main roads. An equipment calibration check was performed before the start and after the completion of all measurements, with no significant variation.

The results of the noise measurements performed at the above locations are shown in Table 3.7.3.

Table 3.7.3 Summary of noise analysis results

Measurements at the location	Period	L _{Aeq,T} dB	L _{Amax,T} dB	L _{A90,T} dB
ML1	Day (07:00-19:00)	57	83	48
ML1	Evening (19:00 – 23:00)	58	82	45
ML1	Night (23:00 – 07:00)	53	80	40
ML2	Day (07:00-19:00)	56	71	51
ML2	Evening (19:00 – 23:00)	55	78	49
ML2	Night (23:00 – 07:00)	52	66	48
RTN1	Day (07:00-19:00)	65	100	52
RTN1	Evening (19:00 – 23:00)	64	94	54
RTN1	Night (23:00 – 07:00)	62	95	43
RTN2	Day (07:00-19:00)	58	81	50

RTN2	Evening (19:00 – 23:00)	58	83	49
RTN2	Night (23:00 – 07:00)	55	79	41
RTN3	Day (07:00-19:00)	65	95	53
RTN3	Evening (19:00 – 23:00)	64	95	52
RTN3	Night (23:00 – 07:00)	62	92	45

LAeq,T is a noise level index called the equivalent continuous noise level in time period T. This is the level of a national constant sound that would contain the same amount of sound energy as the real, possibly fluctuating, sound that was recorded.

LAm_{ax},T A noise level index defined as the maximum noise level in period T. LAm_{ax} is sometimes used to assess occasional loud noises, which may have little effect on the overall noise level Leq, but will still affect the noise environment. Unless otherwise described, it is measured using the fast response of the sound level meter.

LA90,T A noise level index. Noise level exceeded for 90% of the time over the period. LA90,T can be considered to be the "minimum average" noise level and is often used to describe background noise.

Day- measured value

Evening - measured value + 5 dB(A)

Night - measured value +10 dB(A)

The measurement locations have been marked on the map (Figure 3.7.3) to illustrate the position in relation to the Cernavodă NPP site and the nearest residential areas.



Figure 3.7.3 Location of noise measurement points outside the NPP site

Noise levels at all locations studied were observed to be typical of road traffic noise and community noise in a suburban environment. Wind turbines were visible but not audible at any of the measurement sites. It should be noted that the night-time noise levels at ML1 and ML2, representative of the nearest residential areas, are 53 dB LAeq and 52 dB LAeq respectively.

3.8 Population

In accordance with the legal regulations in force - Law 111/1996 on the safe conduct, regulation, authorization and control of nuclear activities, republished, with subsequent amendments and completions and NSN-01 Nuclear safety requirements on siting of nuclear power plants for Cernavodă NPP are established [1]:

- *exclusion zone within a radius of 1 km*- in which no other activities are admitted than those carried out within the NPP; Measures are taken to exclude the location of permanent residences for the population and the development of socio-economic activities that are not directly related to the functioning of the nuclear objectives of the Cernavodă NPP.
- *sparsely populated area* - with a radius of 1 to 2 km from the nuclear objective - in which measures are taken to restrict the location of permanent residences for the population and the development of socio-economic practices.

Exclusion zone with a radius of 1 km

In the exclusion zone of the Cernavodă NPP, no residential buildings are allowed and no other industrial activities are carried out than those subordinated to the NPP activity.

At Cernavodă NPP, the exclusion zone is covered by a distance of 0.600 km from the Bucharest-Constanța railway route. As for the roads, DJ 223C covers the area of the exclusion zone for a distance of approx. 1.5 km. For this area, a protocol is concluded between Cernavodă NPP and Cernavodă Local Council regarding some measures to restrict the road transport of dangerous products with risk of explosion in the Cernavodă NPP area [32].

Within the Cernavodă NPP exclusion zone are located potential sources of explosion (oxygen tanks depots, diesel fuel tanks), which are used during the operation of the NPP. The design and location of these objectives took into account the compliance with adequate protection distances or the provision of special measures (quantity limitation, sufficient natural ventilation, protective walls), so that the integrity of NPP structures, components and systems as well as the security of the operating personnel would not be affected [15].

Sparsely populated area

The closest human settlement to Cernavodă NPP is the city of Cernavodă, with 18,602 people residing on January 1, 2020 - located at approx. 1.6 km NW compared to the Cernavodă NPP platform.

The accommodation campus for Cernavodă NPP workers is located at approx. 1.7 km west of Unit 2.

About 1 km from Unit 2 is the Miruna Hotel, an independent business, and 1.2 km south is a wood storage that served as a restaurant (La Salcâmi). There are other businesses in the area such as car washes (Saab General Auto Services), pharmacies (Romfarmcris SRL, Bryonia) and shops (Foișor).

The following economic units are included in the sparsely populated area: 110/20 kV transformer station, Canal hydrotechnical node (composed of lock, waiting ports upstream and downstream, dam with pumping station, lock maintenance workshop and equipment depot), UNIFY SA [15].

The sparsely populated area is crossed by the following transport routes [15]:

- DN 22 C with km "0" in Cernavodă locality, which ensures the connection between the A2 Fetești - Cernavodă highway and Constanța, with a length of 4.5 km in the area with a radius of 3 km;
- the A2 motorway that connects Fetești and Constanța, with a length of approx. 2 km in the area with a radius of 3 km;
- DJ 223C which connects Saraiu and Ion Corvin, with a length of 2.2 km in the area with a radius of 3 km;

- Bucharest - Constanța railway line number 800, with a length of approx. 4 km in the area;
- the Danube - Black Sea navigable canal, with a length of approx. 3 km in the area.

These transport routes can be used in case of need to evacuate the population of Cernavodă.

According to the emergency plan drawn up by the NPP, the area of influence of the nuclear power plant is considered to be a radius of 30 km around the reactors.

Population distribution in the area with a radius of 30 km

Table 3.8.1 shows the number of inhabitants of the localities within a radius of 30 km from the CTRF project [34].

Table 3.8.1 The number of inhabitants of the localities within a radius of 30 km to the CTRF project

UAT (Territorial administrative unit)	Locality (municipality/city/village)	County	No. of residents 2011	Distance to the project
Adamclisi	Adamclisi Village	Constanța	1113	27 km south
Aliman	Aliman Village	Constanța	745	22 km south
	Dunăreni Village	Constanța	1465	24 km southwest
Castelu	Castelu Village	Constanța	2952	14 miles northeast
	Nisipari Village	Constanța	1904	28 km northeast
Crucea	Crucea Village	Constanța	1056	27 km north
	Stupina Village	Constanța	635	30 km north
Cuza Voda	Cuza Vodă Village	Constanța	3586	20 km northeast
Deleni	Pietreni Village	Constanța	845	25 km southeast
Ion Corvin	Ion Corvin Village	Constanța	575	30 km south
Mircea Vodă	Gherghina Village	Constanța	12	10 km east
	Mircea Vodă Village	Constanța	1922	10 km southeast
	Satu Nou Village	Constanța	2862	15 km east
	Țibrinu Village	Constanța	90	8 km east
Fetesti	Fetești Municipality	Ialomița	34489	18 km west
Medgidia	Medgidia Municipality	Constanța	38016	18 km east
	Valea Dacilor	Constanța	1415	25 km northeast
Nicolae Bălcescu	Dorobanțu Village	Constanța	1691	14 km northeast
	Nicolae Bălcescu Village	Constanța	3066	26.5 km northeast
Cernavodă	Cernavodă City	Constanța	17022	1.6 km northwest
Murfatlar	Siminoc Village	Constanța	1072	29 km northeast
Peștera	Ivrinezu Mic Village	Constanța	410	10 km south
	Ivrinezu Mare Village	Constanța	486	10 km south
	Peștera Village	Constanța	1725	16 km southeast
Poarta Albă	Poarta Albă Village	Constanța	4637	30 km east
Rasova	Cochirleni Village	Constanța	1204	6.7 km southwest
	Rasova Village	Constanța	2558	12 km southwest
Saligny	Făclia Village	Constanța	816	6.1 km southeast
	Saligny Village	Constanța	796	5 km southeast
	Ștefan Cel Mare Village	Constanța	546	2.8 km southeast
Seimeni	Dunărea Village	Constanța	702	24 km southwest
	Seimeni Village	Constanța	489	8.1 km downstream NPP
	Seimenii Mici Village	Constanța	1823	5.5 km north
Siliștea	Siliștea Village	Constanța	608	12.5 km north
Topalu	Capidava Village	Constanța	131	19.5 km downstream NPP
	Topalu Village	Constanța	1654	25.3 km downstream NPP
Tortoman	Tortoman Village	Constanța	1646	13.5 km northeast

Figure 3.8.1 shows the spatial variation of the number of inhabitants of the localities in the area of influence of the CTRF project.

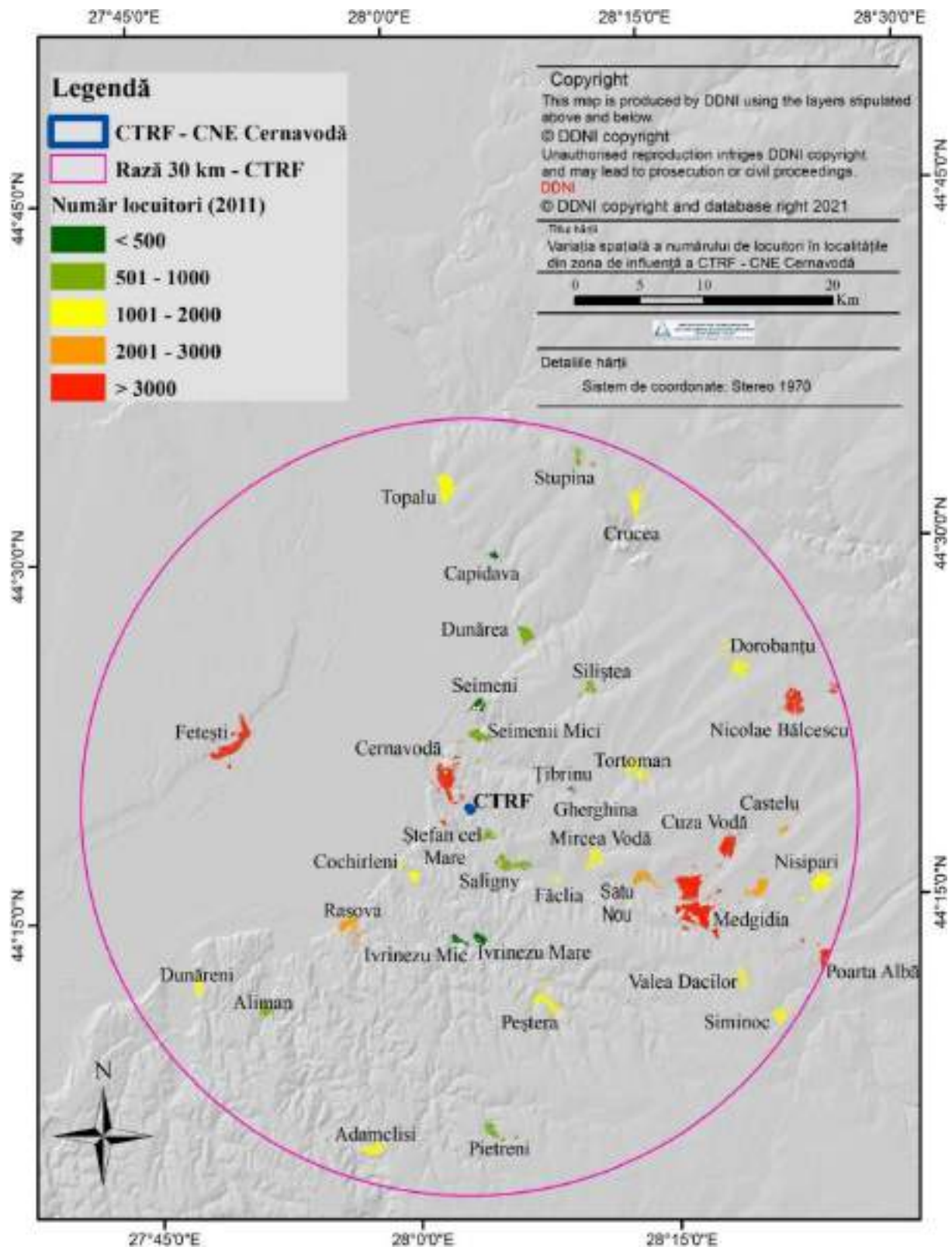

Figure 3.8.1 Spatial variation of the number of inhabitants in the localities in the area of influence of the CTRF project

The population density in the localities located within a radius of 30 km from the CTRF project is presented in Table 3.8.2.

Table 3.8.2 Population density in localities within a radius of 30 km in 2011

Locality	Area (km ²)	Surface (Ha)	Density (loc./km ²)	Density (loc./Ha)
Adamclisi Village	0,90	90,33	1232	12,32
Aliman Village	0,62	61,53	1211	12,11
Capidava Village	0,25	24,66	531	5,31
Castelu Village	1,39	139,40	2118	21,18
Cernavodă City	2,51	251,20	6776	67,76
Cochirleni Village	0,66	65,72	1832	18,32
Crucea Village	1,17	117,26	901	9,01
Cuza Vodă Village	1,44	143,97	2491	24,91
Dorobanțu Village	1,22	122,43	1381	13,81
Dunărea Village	0,92	91,76	765	7,65
Dunăreni Village	0,67	66,83	2192	21,92
Făclia Village	0,56	56,21	1452	14,52
Fetești Municipality	2,47	246,81	13974	139,74
Gherghina Village	0,04	3,61	332	3,32
Ion Corvin Village	0,47	46,67	1232	12,32
Ivrinezu Mare Village	0,58	57,92	839	8,39
Ivrinezu Mic Village	0,44	43,56	941	9,41
Medgidia Municipality	6,15	615,35	6178	61,78
Mircea Vodă Village	1,06	105,58	1820	18,20
Nicolae Bălcescu Village	2,09	208,78	1469	14,69
Nisipari Village	1,53	153,18	1243	12,43
Peștera Village	1,26	125,82	1371	13,71
Pietreni Village	0,80	79,51	1063	10,63
Poarta Albă Village	1,35	135,29	3427	34,27
Rasova Village	1,32	132,38	1932	19,32
Saligny Village	0,79	78,83	1010	10,10
Satu Nou Village	0,96	96,15	2977	29,77
Seimeni Village	0,57	56,78	861	8,61
Seimenii Mici Village	1,00	100,08	1821	18,21
Siliștea Village	0,54	54,23	1121	11,21
Siminoc Village	0,73	72,77	1473	14,73
Ștefan Cel Mare Village	0,51	50,73	1076	10,76
Stupina Village	0,48	47,99	1323	13,23
Țibrinu Village	0,12	11,67	771	7,71
Topalu Village	1,77	177,22	933	9,33
Tortoman Village	1,13	113,25	1453	14,53
Valea Dacilor	0,59	59,09	2395	23,95

About 90% of Constanta's population are ethnic Romanians, 3.3% Turks, 3.1% Tatars, 1.3% Romanies and other ethnic groups [35]. According to the latest available census data, from 2011, the Romanies constitute 3.2% of the Romanian population.

Socio-economic conditions

The economic activity in the area of influence of Cernavodă NPP consists of: extractive industry (limestone quarries, sand, diatomite, bentonite, clay), industrial units concentrated in existing industrial areas in Cernavodă, Fetești and Medgidia and agro-industrial units spread in localities rural areas.

The economic activities in the area of influence of Cernavodă NPP are grouped in the following areas:

- Area with a radius of 10 km
 - Cernavodă-Saligny industrial area
 - Cernavodă industrial-port area
- Area with a radius of 10-30 km
 - Medgidia Nord industrial area
 - Industrial-port area Medgidia East
 - Fetești North-West industrial area
 - Fetești East industrial area

According to the IAEA recommendations [36], *the economic facilities located at a distance of more than 10 km from the Cernavodă NPP do not affect the security of the plant.* Therefore, all the economic objectives located within a radius of approx. 10 km around Cernavodă NPP were analyzed; for longer distances, only the most important economic objectives in terms of production capacities and hazardous substances involved in the production process were selected from the area of influence considered.

In 2019, the situation of human activities previously identified in the area with a radius of 10 km and the objectives with high impact potential located at a distance of less than 25 km were re-evaluated in detail. The method used was field reconnaissance, interviewing and engineering judgment. This approach is in line with IAEA recommendations [36].

Table 3.8.3 briefly presents the data that characterize these economic objectives, namely: the economic agent, the position regarding NPP, the main raw materials used, the main products made, the hazardous substances (toxic, flammable, explosive) involved in the production process and their storage method.

Table 3.8.3 Industrial activities carried out in the area of influence of Cernavodă NPP [15]

Crt. no.	Industrial facility	Description of the activity	Materials	Amount	Danger	Distance from NPP [km]	Stored in
Zone 0 - 10 km							
1.	SC Cernavodă SHIPYARD SRL	Ship repair workshop, metal conditioning, ship transport	Paint Propane O2 Thinner	4500 kg 4500 l 5000 l 500 l	Flammable, explosive, smoke, toxic gases	4.74	Metal tanks placed in buildings
2	SC PETROM	Gas station	Benzine Diesel	4 t 6 t	Flammable, smoke, toxic gases	3.13	Metal tanks in the basement
3	MOL	Gas station	Benzine Diesel Propane	20 t 20 t 30 m3	Flammable, explosive, smoke, toxic gases	2.55	2 metal tanks in the basement and 1 metal tank on the ground
4	UNIFY	Paints and anticorrosives (services)	Paint Thinner	2000 kg 600 l	Flammable, smoke, toxic gases	2.34	Metal tanks placed on the ground
5			Diesel	63872 l		2.15	

Crt. no.	Industrial facility	Description of the activity	Materials	Amount	Danger	Distance from NPP [km]	Stored in
	Transporturi SNN	SNN Transport Section	Benzine	21664 l	Flammable, smoke, toxic gases		85,500 l in metal tanks in the basement and 4800 t in a metal tank in a building
			Petrol	4800 t			
6	SC NOVA HOLDING SRL	Bottled propane	Propane	100 m3 (50 t)	Explosive	4.66	Metal tank on the ground
7	PT 14	Thermal energy distribution station	Petrol	47 t	Flammable, smoke, toxic gases	3.06	Metal tank in the basement
8	PT 11	Thermal energy distribution station	Petrol	52 t	Flammable, smoke, toxic gases	1.91	50t metal tanks in the basement, 2 t in a metal tank in a building
9	PT // campus	Thermal energy distribution station	Petrol	3x40000 l	Flammable, smoke, toxic gases	1.55	Metal tanks in the basement
10	SEIRU	SNN materials warehouse (chemicals, equipment)	Petrol	2 x 5 t + 2.5 t	Flammable, explosive, smoke, toxic gases	1.59	12 t metal tanks in the basement and 2.5 t in metal tank on the ground
			Diesel	2 t			
			Oils	41000 l			
			Resins	2740 kg			Cylinders, tanks, containers, recipients stored in 3 buildings
			Acids	9650 l			
			Solid substances	9040 kg			
Zone 10 - 30 km [Fetești (17 km)]							
14	Romp petrol, towards Bărăganu	Gas station	Benzine	10 t			Metal tanks in the basement
			Diesel	10 t			
15	PECO 2, towards Bărăganu	Gas station, decommissioned	Benzine	20 t	Flammable, explosive, smoke, toxic gases		2 metal tanks in the basement and 1 metal tank on the surface
			Diesel	20 t			
			Propane	30 m3			
16	OMV Petrom, motorway entrance	Gas station	Benzine	2x 20 t	Flammable, smoke, toxic gases		2 metal tanks in the basement
			Diesel	2 x 20 t			
17	Mobil, highway entrance	Gas station	Benzine	20 t	Flammable, smoke, toxic gases		2 metal tanks in the basement
			Diesel	20 t			
Zone 10 - 30 km [Medgidia (20 km)]							

Crt. no.	Industrial facility	Description of the activity	Materials	Amount	Danger	Distance from NPP [km]	Stored in
18	SC Dobromin	Extraction and manufacture of clay	Oils	50 t	Flammable, smoke, toxic gases		Metal tanks placed on the ground
			Diesel	15 t			
19	SC STERK SA, Sos. Constanței	Plastics factory	Plastics	600 t	Flammable, smoke, toxic gases		On the ground
	SC LAFARGE SOMCIM SA	Cement and limestone factory	Astralite	7200 kg / year	Flammable, explosive, smoke, toxic gases		Building, 5x14000 t in metal tanks placed on the ground, 3x120 t in metal tanks placed on the ground.
			Nitramonium	73950 kg / year			
			HFO	90000 t / year			
			Diesel	2300 t / year			
			Petrol	80000 t / year			
20	RAJDP	Bitumen station	Diesel	10 t	Flammable, smoke, toxic gases		Metal tank placed on the ground
21	SC METALICA SA	Metal processing	Acid	600 kg	Toxic gases		Glass container

The industrial areas presented in table 3.8.3 are maintained as potential factors of economic development in the localities of the studied territory. In principle, in the future there may be a process of modernization and rehabilitation of existing objectives, but also reprofiling or placement of new economic objectives in the area of influence of Cernavodă NPP.

Constanța County is characterized by a significant difference between the employment rate among men and that among women. Thus, in 2018, 61% of the unemployed were female, while the male had a share of 39%. The main professions in which women were employed are: i) medical and social assistance (86.2% of workers are women); ii) financial services and insurance (80.8% of workers are women); education (80.5% of workers are women). At the same time, males predominate in occupations such as: i) transport and storage (84% of workers are men); ii) mining and quarries (83.3% of workers are men); iii) constructions (82.3% of workers are men) [37].

3.9 Tangible assets

In order to identify the buildings in the vicinity of the CTRF project, an area of influence was delimited within a radius of 2 km around the site, taking into account the sparsely populated area established for Cernavodă NPP. This identification was done in GIS, and the buildings were identified based on the high-resolution satellite images included in Bing Maps. These were accessed in the ArcGIS 10.5 software via the ArcBruTile 0.7 extension. Thus, in the defined area, 172 buildings were identified that are located in this area of influence. The other buildings belonging to the Cernavodă NPP premises were excluded from this identification process. A number of 122 buildings are included in the category of residential buildings, of which 90 are in Cernavodă and 32 in the village of Ștefan Cel Mare in Saligny Commune. A number of 31 residential buildings were identified as part of the Accommodation Campuses (Campus 1 and Campus 3) near Cernavodă NPP. Another 49 buildings identified in the delimited area are classified as industrial, of which 7 are in the city of Cernavodă and belong to the 400 kV Cernavodă Power Plant. The other 42 industrial buildings are located in Ștefan cel Mare, 16 of them belong to Sursal SA Saligny. A commercial building was also identified, belonging to Popasul La Mihai in the village of Ștefan cel Mare.

Other structures in this area are represented by the network of roads and railways. In total, 18.72 km of roads were identified in the reference area. Of these, 3.33 km belong to County Road 223 (DJ223) and 2.71 km belong to National Road 22C (DN22C). The nearest railway station in the area of influence of the project is Bucharest - Constanța.

Mineral resources

Within this area of influence as defined above, no mineral resources are found.

Water resources

Water resources are presented in subchapters 3.1.1 and 3.1.2.

3.9.1 Archaeological sites

In the area of the CTRF project site, there are no cultural heritage assets of national importance in the National Archaeological Repertory (RAN) of the National Heritage Institute of Romania. Table 3.9.1.1 lists and briefly describes other archaeological sites identified in the Cernavodă City area and in the immediate vicinity.

Table 3.9.1.1 Archaeological sites registered at and near the National Archaeological Repertory of Cernavodă

No. RAN	Name	Location / Description	Distance to the project	Period
60785.29	Early Roman settlement in Cernavodă	The settlement is located on the plateau located north of Dealul Lupului. Local and Roman ceramic fragments were discovered here.	3 km southwest of the project	Roman
60785.28	Cernavodă settlement - Aleca Hill.	The settlement is located on Dealul Aleca, and is located in the southern part of Cernavodă.	5 km south of the project	Neolithic, Bronze Age
60785.27	Cernavodă Settlement - Platou	The settlement is located on a plateau. The northern third of this plateau is protected on the east, north and west sides by a stone and earth enclosure, and on the south by the stone wave (Valul de piatră) (RAN code - 60785.04) which is oriented crosswise from west to east.	4.5 km south of the project	4th century BC Medieval (10th-11th centuries)
60785.26	Settlement and ritual area in Cernavodă	The settlement is located about 1500 m northeast of the fortress of Axiopolis, on a plateau located on the southern bank of the Danube - Black Sea Canal	2 km west of the project	Bronze Age, Roman
60785.25	Earth wall (fortification) at Cernavodă	This segment of the wall is arranged on the west-east direction and crosses the southern perimeter of the Cernavodă Administrative Territorial Unit (ATU). The length of the segment is about 800-900 m, on the eastern half of it being located two castles.	6.5 km south of the project	Unknown
60785.24	Castrum (fortress) Cernavodă - Castrum No. 4	The camp (Castrum) is positioned in the western part of Valea Sumedrea, and to its east it is represented by the continuation of the stone wall (LMI. Nr. CT-ImA02559.01).	6.5 km south of the project	Roman
60785.23	Castrum (fortress) Cernavodă - Castrum no. 3	The camp (Castrum) is located about 800 m southeast of camp no. 2 (RAN code 60785.22).	5 km south of the project	Roman
60785.22	Castrum (fortress) Cernavodă - Castrum No. 2	The camp (Castrum) is located about 800 m east of Dealul Lupului and north of the stone wave.	3.5 km south of the project	Roman

60785.21	Necropolis Cernavodă – Pădurea Mică	Necropolis is located in the northern part of the village, on a terrace near „Pădurea Mică”. Cremation graves with stone mantle.	5.5 km north of the project	4th century BC
60785.20	Cernavodă Settlement – Valea Dobrescu	The settlement is located in the northern part of Podisul Columbia (RAN code 60785.19). Hamangian culture.	4.5 km north of the project	Neolithic
60785.19	Cernavodă Settlement – Platou Columbia	The settlement is located on the Columbia plateau, north of Dealul Sofia (RAN code - 60785.01). This perimeter is delimited by Galcia and Avram Iancu streets. Hamangian culture.	4.5 km north of the project	Neolithic
60785.07	Cariera de piatră Cernavodă (Cernavodă stone quarry)	The quarry is located 400 m south of the Constanța end of the A. Saligny bridge. An ancient stone quarry was discovered in which parallel structures were mined. 5 excavations were reported which were presented in the form of rectangular chambers, arranged from N to S along the river. In room 4, a bas-relief was discovered that could have been Hercules Saxanus.	4 km northwest of the project	Middle Ages (10th century)
60785.06	Medieval settlement in Cernavodă - Dealul Vifor	The settlement is located 300 m from „Uzina de apă” on Vifor Hill, through Farm 4 of IAS Cernavodă. Two ceramic vessels containing Turkish silver coins were discovered, with a total of 2394 coins weighing a total of 40 kg. It is estimated that the coins date from the time of Sultans Süleyman II, Ahmed II, Mustafa II, Ahmed III, and were issued in the cities of Constantinople, Adrianople, Izmir, Erzerum.	4 km northwest of the project	Middle Ages, XVII-XVIII centuries
60785.08	Neolithic archeological site in Cernavodă - Coada Zavoi	The archeological site consists of a settlement and a necropolis and is located in the north of Cernavodă, near the Danube. An important Hamangia cemetery with 400 graves was excavated in the 1950s and 1960s in Cernavodă.	5 km north of the project	Neolithic
60785.30	Getic settlement in Cernavodă	It is located in the southern part of the former Carasu Valley, the current Danube - Black Sea Canal, at the base of Aleca hill, in front of the dam associated with the irrigation canal. Hellenistic and indigenous ceramic fragments have been identified.	5 km south of the project	The Iron Age
60785.18	Cernavodă Archaeological site - Columbia A	The site is close to the city slaughterhouse. In combination with the typical Hamangia pottery, other pottery fragments specific to the Boian I culture, the Giulești variant of Muntenia, were also discovered.	4.5 km northwest of the project	Neolithic
60785.17	Cernavodă Tumuli	A2 motorway (km 170 + 100 - 170 + 900).	3 km northwest of the project (location of the	Unknown

			general point on the RAN)	
60785.16	Cernavodă Tumuli	A2 motorway (km 168 + 800 - 169 + 800).	3 km northwest of the project (location of the general point on the RAN)	Unknown
60785.15	Cernavodă Tumuli	A2 km motorway (168 + 650 - 168 + 800).	3 km northwest of the project (location of the general point on the RAN)	Unknown
60785.14	Cernavodă Tumuli	A2 motorway (km 167 + 600-167 + 700).	3 km northwest of the project (location of the general point on the RAN)	Unknown
60785.13	Cernavodă Tumuli	A2 motorway (km 163 + 050 - 163 + 150). south of the canal.	3 km northwest of the project (location of the general point on the RAN)	Unknown
60785.12	Roman settlement in Cernavodă	A2 motorway (km 158 + 000 - 158 + 200).	3 km northwest of the project (location of the general point on the RAN)	Romania
60785.11	Cernavodă Tumuli	A2 motorway (km 157 + 600 - 157 + 800).	3 km northwest of the project (location of the general point on the RAN)	Unknown
60785.10	Archaeological site Cernavodă	The A2 motorway (km 153 + 800 - 154 +000), located on a cleared plateau crossed from east to west by a recently excavated ditch.	3 km northwest of the project (location of the general point on the RAN)	Roman, Medieval
60785.09	Castrum of Cernavodă - Dealul Dermengi	The castrum is located in the area between Ramadan and Purcăreți lakes, located northeast of the town of Cernavodă, on an extension of the Dermengi hill. Castrum is located in an area strongly affected by the excavation of the cooling water evacuation canal, used at Cernavodă NPP.	3 km northwest of the project (location of the general point on the RAN)	Roman
62324.01	Paleolithic site - Saligny	About 30 pieces of flint processed in the Middle Paleolithic have been found	5 km southeast of the project	Paleolithic
62351.01	Țibrinu – Țibrinu Lake	This is the nearest site where Mesolithic remains have been found.	7 km northeast of the project	Mesolithic

In addition, 6 other important archaeological sites have been identified within a 30 km radius around the Cernavodă NPP site which includes the CTRF project site (Table 3.9.1.2).

Table 3.9.1.2 List of archeological sites within a radius of 30 km around the site, other than those mentioned above

LMI Code 2015	Name	Location	Distance to the project	Period
CT-IsA-02600	Archaeological site "Cetatea Capidava	At the SW edge of the village, on the Danube bank, to the S of DJ 223	~ 20 km (loc. Capidava)	-
CT-ImA-02600.01	Capidava Fortress (Cetatea Capidava)	At the SW edge of the village, on the Danube bank, to the S of DJ 223	~ 20 km (Capidava locality)	century VIII - XI, Early medieval period
CT-ImA-02600.02	Civil settlement	At the SW edge of the village, on the Danube bank, to the S of DJ 223	~ 20 km (Capidava locality)	century VIII - XI, Early medieval period
CT-ImA-02600.03	Capidava Fortress (Cetatea Capidava)	At the SW edge of the village, on the Danube bank, to the S of DJ 223	~ 20 km (Capidava locality)	century II - VII, Roman era
CT-ImA-02600.04	Civil settlement	At the SW edge of the village, on the Danube bank, to the S of DJ 223	~ 20 km (Capidava locality)	century II - VII, Roman era
CT-ImA-02691.03	Sucidava Fortress (Cetatea Sucidava)	"Cale-Gherghi", on the bank of the Danube, 3 km downstream from the village	~ 25 km (loc. Dunareni)	century II - VI AD, Roman era

3.9.2 Historical monuments

In the vicinity of the CTRF project site there are no UNESCO-listed cultural heritage assets of international importance.

Also, in the study area there are no assets of the national cultural heritage included in the List of Historical Monuments (LMI) of the National Institute of Romanian Heritage.

Table 3.9.1.3 describes the historical monuments identified in the area of Cernavodă.

Table 3.9.1.3 List of historical monuments in the city of Cernavodă

LMI Code 2015	Category	Name	Location	Distance to the project	Date
CT-ImA-02559.01	A	Zid de piatră (Stone wall)	In the immediate vicinity of Hinog Island and the fortress of Axiopolis, on the right bank of the Danube, 3.25 km S of Cernavodă.	3 km southwest of the project.	10th century, early Middle Ages
CT-IsA02619	A	Situl arheologic de la Cernavodă, Punct "Dealul Sofia" (Cernavodă Archaeological Site, "Dealul Sofia" Point)	„Dealul Sofia”, which extends from 100 m west of the City Hall to the Danube bank.	4.5 km northwest of the project.	Unknown
CT-Im-A02619.01	A	Settlement	„Dealul Sofia“ which stretches from 100 m W of the City Hall to the Danube bank.	4.5 km northwest of the project	The transition period to the Bronze Age - Cernavodă Culture, I, II, III

CT-Im-A02619.01	A	Settlement	"Sofia Hill", starting from 100 m W from the City Hall to the Danube bank.	4.5 km northwest of the project.	Neolithic - culture Gumelnița
CT-IsA02620	A	Cernavodă Archaeological Site, "Citadela Axiopolis"	3 km south of Cernavodă, in front of the Hinog island, located on the right bank of the Danube.	4 km southwest of the project.	Unknown
CT-ImA-02620.01	A	Fortăreața Axiopolis (Axiopolis Fortress)	3 km S of Cernavodă, in front of Hinog Island, on the right bank of the Danube River.	4 km southwest of the project.	4th century BC-7th century AD La Tene (Iron Age), Roman, Byzantine.
CT-ImA-02620.02	A	Necropola Axiopolis (Axiopolis Necropolis)	4.5 km from DJ 223, Cernavodă Cochirleni section and 70 m west of the road.	4 km southwest of the project.	6th century AD Roman - Byzantine
CT-ImA-02620.03	A	Tumulus	4.5 km from DJ 223, Cernavodă Cochirleni section and 70 m west of the road.	3 km southwest of the project.	Ancient (prehistoric)
CT-II-mA02872	A	Carol I Bridge with the "Dorobanții" statues	It is built over the Danube, near the CFR station, Cernavodă.	3 km northwest of the project.	1890–1895
CT-II-sB02875	B	Urban site of Cernavodă	Str. Dacia, Eminescu M., Ovidiu, Bălcescu N., Asachi Gh., Canalului, Călărași	3 km northwest of the project.	Unknown
CT-II-mA02873	A	The church „Sf. Împărați Constantin și Elena”	Str. Canalului	3 km northwest of the project.	1882–1895
CT-II-mA02874	A	Mosque	Str. Crișan 4.	3 km northwest of the project.	1756
CT-II-mB02876	B	House	Str. Dacia 5.	3 km northwest of the project.	1907
CT-II-mB02877	B	House with commercial spaces	Str. Dacia 24.	3 km northwest of the project.	XIX-XX centuries
CT-II-mB02878	B	House	Str. Dumbravei 15.	3 km northwest of the project.	XX century
CT-II-mB02879	B	Former school	Str. Mircea cel Bătrân 7.	3 km northwest of the project.	XIX-XX centuries

These historical monuments were identified by consulting the List of Historical Monuments in Romania (LMI), updated in 2015 by the National Institute of Heritage.

4. DESCRIPTION OF THE ENVIRONMENTAL FACTORS LIKELY TO BE AFFECTED BY THE PROJECT

The potential effects of the CTRF project on environmental factors will be analyzed over an area of at least 30 km around Cernavodă NPP, to identify environmental factors likely to be affected by the project. This area has been established, based on the analysis of the requirements of the monitoring programmes requested by the regulatory authorities for the operation of Cernavodă NPP and the Guidance issued by MMAP for conducting of RIM (DEICP / 885 / 10.09.2020).

Cernavodă NPP has been carrying out, since the commissioning of the first unit, a comprehensive program for monitoring environmental radioactivity, which has so far served as a basis for maintaining the environmental authorization and as a support in assessing the radiological impact on the environment and population as a result of the operation of its own nuclear and radiological installations. This area, 30 km around the plant, is considered relevant by the authorities to monitor the potential impact of the normal operation of Cernavodă NPP. The CTRF project will operate within the NPP and the Environmental Monitoring Programme at the Cernavodă NPP site, developed in accordance with the requirements - NSR 22, Standard for Environmental Radioactivity Monitoring in the Vicinity of a Nuclear or Radiological Facility, will include monitoring of effluents from the CTRF, thus ensuring monitoring of the radiological impact of CTRF operation on receiving environments.

This monitoring program includes sampling and radioactivity measurements and is developed in accordance with the requirements of the CNCAN standards. In the description of the environmental factors likely to be affected by the CTRF project, the data obtained under this program will be used, which will be supplemented with the results of analysis performed between September 2020 and July 2021 by the RENAR accredited laboratory and CNCAN notified within ICSI Rm. Vâlcea and the CNCAN notified laboratory within RATEN ICN Pitești.

The analysis performed by accredited / notified laboratories RENAR / CNCAN aimed to compare the results of the monitoring programme carried out at Cernavodă NPP, by verifying the contamination of environmental factors in the vicinity of the source and supplementing these results with content measurements for alpha-emitting radionuclides.

For the analysis performed, the sampling locations and intervals were chosen in such a way that the analysis were relevant for the identification of the presence, in the monitored environmental factors, of the analyzed radionuclides as well as of the non-radioactive contaminants.

4.1 The environmental factor water

Regarding the monitoring of surface water pollution, the sampling was carried out directly from the discharge canal - Valea Seimeni (Danube river emissary), this being the normal way for discharging liquid effluents from Cernavodă NPP (Danube-Black Sea canal – bief II it is used as a discharge route when carrying out works on the Seimeni evacuation way). Also, samples were taken from the domestic wastewater collection systems on the Cernavodă NPP platform, these being collected for treatment and purification in Cernavodă's sewage treatment plant. For groundwater and drinking water sources in the vicinity of Cernavodă NPP, samples were taken directly from the pumping systems (deep well drilling - Fj1 and Fj2) of the plant, and for drinking water from neighboring localities samples were taken from the supply network of Cernavodă, its source being considered as the most affected in the case of radioactive emissions of the plant, as a consequence of its proximity to the emission source.

4.1.1 Qualitative radioactivity analysis for surface waters

For the water environmental factor, the environmental radioactivity monitoring program includes weekly surface water sampling, followed by monthly composition and measurement, for two indicator locations (*LII-05 - Cernavodă, liquid effluent discharge in CDMN and LII-06 - Seimeni, liquid effluent discharge into the Danube*) and a reference location (SSS-02 Cernavodă, Danube). In 2020, the determinations of the content of gamma radiation emitting radionuclides did not show a presence above the detection limit (this being lower than the value of 1 Bq / l for each of the anthropogenic radionuclides considered). The annual average global beta activity at the indicator locations was less than 0.1 Bq / l, while the average concentration of global beta activity at the

reference location was 0.07 Bq / l. The annual average concentration of tritium in the indicator locations was 96 Bq / l, while the average concentration in the reference location was 17 Bq / l.

The September 2020 analysis, performed by ICSI Rm. Vâlcea, for surface waters consisted of determinations of tritium and C-14 concentration, as well as determinations of beta-global and gamma-spectrometric activity concentrations in 3 samples taken from the Danube (km 292 – Seimeni and km 295 - confluence of the discharge canal, Saligny Bridge - Cernavodă). The results of these analysis are presented in Chapter 3 and indicate (momentary) values of global beta activity and tritium concentrations, lower than the average values of the corresponding parameters, in the monitoring program, carried out by Cernavodă NPP. At the same time, the analysis for determining the activity concentration of the gamma radiation emitting radionuclides did not reveal the presence of some anthropogenic radionuclides specific to NPP, in the surface waters. With regard to C-14, it is noted that the values of its activity concentration in surface waters in the area of influence of the Cernavodă NPP are at the level of the natural background, which in the specific literature is appointed with an actual average value of 238 Bq/kg C [97].

The results of the analysis performed by RATEN ICN Pitești, presented in Chapter 3, show that, in the surface waters, the radionuclide emitting alpha radiation, from the actinide series, cannot be identified as being attributed to the operation of nuclear installations on the Cernavoda NPP platform.

Also, the analysis carried out by ICSI Rm. Vâlcea and RATEN ICN Pitești collected samples from the domestic water collector in the vicinity of the access control point from U1, in order to radiologically characterize them. This type of sampling was included in the monitoring as the wastewater collected on the Cernavodă NPP platform is discharged to the Cernavodă Wastewater Treatment Plant, where it is processed for treatment and then discharged into the Danube River. The monitoring performed by ICSI Rm. Vâlcea showed a tritium concentration of 3.9 Bq/l and an overall beta global activity concentration of 0.26 Bq/l in the domestic water samples taken in 2020. The activity concentration of C-14 was 0.096 Bq / g C, a value between the one for the deep groundwater used as drinking water on the site and the one of the surface water, which can be explained by the increased carbon content of the water (organic carbon loading), the addition having the C-14 activity concentration corresponding to modern carbon. The analysis to determine the activity concentration of actinides showed results similar to those obtained for deep groundwater (used as a source for drinking water - discharged as domestic water), thus negating any potential contamination with this category of radionuclides from the Cernavodă NPP platform.

Conclusion: In terms of radioactivity, both the results of monitoring carried out by CNE Cernavodă, through the Environmental Radioactivity Monitoring Programme, and the results of analyses carried out by ICSI Rm. Vâlcea and RATEN ICN Pitești, in 2020 and 2021, showed that the surface waters in the area of influence of the Cernavodă NPP are not affected by the liquid effluent emissions from the plant, the only radionuclide found in the samples analysed being tritium, however this is at a concentration level below the reference level of 100 Bq/l, provided for in Law 301/2015, on the establishment of requirements for the protection of the health of the population with regard to radioactive substances in drinking water.

4.1.2 Qualitative physico-chemical analysis for surface waters

For surface waters, the September 2020 analysis, carried out by ICSI Rm. Vâlcea included a set of analysis of physico-chemical indicators, with the results centralized in Tables 4.1.2.1 and 4.1.2.2.

Table 4.1.2.1. The results of the physico-chemical analysis obtained for the monitoring point Danube Km 292 – Seimeni

Crt. no.	Physico-chemical indicators analyzed	Analysis method	Obtained results	Maximum allowed limit (AGA)	No. analysis report
1.	pH (25 ° C)	SR EN ISO 10523/2012 PS-LACAFC-AFC-13	8.3 upH	6,5 – 9,0 upH	138 / 05.11.2020
2.	Chlorides	SR EN ISO 9297/2001 PS-LACAFC-AFC-11	22.69 mg/l	250 mg/L	
3.	Calcium	SR EN ISO 7980/2002 PS-LACAFC-AFC-09	49.98 mg/l	150 mg/L	
4.	Magnesium	SR EN ISO 7980/2002 PS-LACAFC-AFC-15	10.10 mg/l	50 mg/L	
5.	Total iron	SR EN ISO 6332:1996/C91:2006 PS-LACAFC-AFC-13	<0.02mg/l ⁽²⁾	1,5 mg/L	
6.	Permanganate index	SR EN ISO 8467:20001 PS-LACAFC-AFC-14	4.48 mg O ₂ /l	-	
7.	Sulphates	ASTM D 515:2011 PS-LACAFC-AFC-06	28.65 mg/l	200 mg/L	
8.	Ammonium	SR EN ISO7150-1:2001 PS-LACAFC-AFC-16	<0.04 mg/l ⁽²⁾	3 mg/L	
9.	Sodium	ISO 9964-1/1993 PS-LACAFC-AFC-17	12.12 mg/l	100 mg/L	
10.	Suspension matter	SR EN 872:2005 PS-LACAFC-AFC-16	5.2 mg/l	25 mg/L	
11.	Biochemical oxygen consumption	PS-LACAFC03-DCBO5-01 Ed 4,rev.0/ Analysis kit:HACH-LANGE LCK555	<1.2 mgO ₂ /l ⁽²⁾	15 mg/L	
12.	Total phosphorus	PS-LACAFC03-DP-01 Ed 3,rev.0/Analysis kit:HACH-LCK348	<0.5 mg/l ⁽²⁾	1 mg/L	
13.	Petroleum products	SR 7877-1:1995	<10 mg/dm ³⁽³⁾	5 mg/L	

Table 4.1.2.1.2 The results of the physico-chemical analysis obtained for the monitoring point Pod (Bridge) NPP - Cernavodă

Crt. no.	Physico-chemical indicators analyzed	Analysis method	Obtained results	Maximum allowed limit (AGA)	No. analysis report
1.	pH (25 ° C)	SR EN ISO 10523/2012 PS-LACAFC-AFC-13	8.3 upH	6,5 – 9,0 upH	139 / 05.11.2020
2.	Chlorides	SR EN ISO 9297/2001 PS-LACAFC-AFC-11	22.69 mg/l	250 mg/L	
3.	Calcium	SR EN ISO 7980/2002 PS-LACAFC-AFC-09	51.33 mg/l	150 mg/L	
4.	Magnesium	SR EN ISO 7980/2002 PS-LACAFC-AFC-15	9.016 mg/l	50 mg/L	
5.	Total iron	SR EN ISO 6332:1996/C91:2006 PS-LACAFC-AFC-13	<0.02mg/l ⁽²⁾	1,5 mg/L	

6.	Permanganate index	SR EN ISO 8467:20001 PS-LACAFC-AFC-14	3.84 mg O ₂ /l	-
7.	Sulphates	ASTM D 515:2011 PS-LACAFC-AFC-06	27.99 mg/l	200 mg/L
8.	Ammonium	SR EN ISO7150-1:2001 PS-LACAFC-AFC-16	<0.04 mg/l ⁽²⁾	3 mg/L
9.	Sodium	ISO 9964-1/1993 PS-LACAFC-AFC-17	12.33 mg/l	100 mg/L
10.	Suspension matter	SR EN 872:2005 PS-LACAFC-AFC-16	10.4 mg/l	25 mg/L
11.	Biochemical oxygen consumption	PS-LACAFC-A03- DCBO5-01 Ed 4,rev.0/ Analysis kit :HACH- LANGE LCK555	<1.2 mgO ₂ /l ⁽²⁾	15 mg/L
12.	Total phosphorus	PS-LACAFC-A03-DP-01 Ed 3,rev.0/ Analysis kit:HACH-LCK348	<0.5 mg/l ⁽²⁾	1 mg/L
13.	Petroleum products	SR 7877-1:1995	<10 mg/dm ³⁽³⁾	5 mg/L

From the analysis of the data results for the chemical parameters, it is found that the values obtained were within the limits imposed by the Water Management Authorization Modifying Authorization No. 58/07.2021, No. 72 of 06.09.2021 for Cernavodă NPP U1 and U2. Moreover, the comparative analysis between the results obtained following the analysis from September 2020, performed by ICSI Rm. Vâlcea and the results of the physico-chemical indicators from the same year, obtained by the NPP Chemical Laboratory, highlights the fact that the 2 sets of analysis performed, show comparable values.

Conclusion: Referring to the Water Management Authorization Amending Authorization No. 58/07.2021, No. 72 of 06.09.2021 for Cernavodă NPP U1 and U2, it is noted that the indicators analysed did not show exceedances of the maximum permitted limits. Taking into account these aspects, as well as the quality and volume of liquid effluents that will be generated by the CTRF, the potential of affecting surface waters is excluded. This is also supported by the detailed impact analysis in Chapter 5.

4.1.3 Qualitative analysis from the point of view of radioactivity for drinking water

In the area of influence of Cernavodă NPP, the sources of drinking water likely to be affected by radioactive emissions from the site are: the Danube River (as a source of drinking water for the inhabitants of Cernavodă and Seimeni) and the Danube-Black Sea Canal (for the inhabitants of the localities along the canal downstream from the Cernavodă NPP). On the Cernavodă NPP platform, drinking water is provided by pumping from the two well drillings described above, after filtration and treatment in the Drinking Water Treatment Plant.

The radiological monitoring programme provides for monthly sampling from five collection points, as follows: All-03 Cernavodă, SSS-03, Saligny, SSS-13 Cernavodă-LCM, SSS-15 Făclia and SSS-16 Seimeni.

In 2020, in the environmental report [84], it is shown that the values of the global beta activity concentration were below the limit of 1 Bq / l for all of the analyzed samples. Also, the values of the activity concentration of the gamma emitting radionuclides were below the detection limit, and the tritium-mediated concentration was lower than the detection limit (3 Bq / l) for most locations. The above results show that the discharges of liquid effluents from Cernavodă NPP do not affect the water quality in the emissary insofar as it can no longer be used as a source of drinking water. Thus, according to the provisions of Law 301/2015, the value of the tritium activity concentration must be lower than the reference value of 100 Bq / l and the residual beta activity (the difference between the global beta activity concentration and the K-40 radionuclide activity concentration) must be less than 1 Bq / l for water to be used for human consumption.

Some values of tritium activity concentration above the detection limit were recorded in August

and September 2020, the highest being 12 Bq/l, which is much lower than the reference level of 100 Bq/l set by Law 301/2015. Thus, in terms of monitoring performed by ICSI, in the drinking water samples taken from the NPP site and from the supply network of the city of Cernavodă, values of the global beta activity concentration lower than 0.06 Bq / l and values of tritium concentration lower than 0.4 Bq / l were determined, these being comparable with the values obtained under the Cernavodă NPP monitoring programme.

Unlike deep groundwater (CNE drinking water source), in the drinking water sample taken from LCM (originating from the RAJA SA distribution system in Cernavodă), the level of C-14 concentration was 0.204 Bq / g C, a value corresponding to the level of background activity. As in the case of the deep groundwater sample, even in the drinking water sample taken from LCM, in June 2021, RATEN ICN Pitești did not show the presence of actinides, above the detection limit (indicated with values lower than 0.001 Bq / l), with the exception of uranium isotopes, having activity concentrations corresponding to a chemical concentration level below 2 micrograms of natural Uranium per liter of water.

Conclusion: In terms of radioactivity, both the results of monitoring carried out by CNE Cernavodă, through the Environmental Radioactivity Monitoring Programme, and the results of the analysis carried out by ICSI Rm. Vâlcea and RATEN ICN Pitești, in 2020 and 2021, have shown that effluent emissions from the Cernavoda NPP do not affect the quality of drinking water sources in the area of influence of Cernavodă NPP, the only radionuclide found in some drinking water samples being tritium, with activity concentration values much lower than the reference level established by Law 301/2015.

4.1.4 Qualitative radioactivity analysis for deep groundwater

The deep groundwater is monitored through monthly samples taken from the two deep (drilling) wells on the Cernavodă NPP site. In 2020, gamma spectrometric analysis performed on these samples did not reveal the presence of manmade radionuclides specific to the CANDU reactor. The average global specific beta activity for the samples taken during 2020 was 0.08 Bq / l. For all samples analyzed, the specific tritium concentration was lower than the Minimum Detectable Activity (3.2 Bq / L). The results of the monitoring performed by Cernavodă NPP and the analysis performed by ICSI Rm. Vâlcea showed a tritium concentration below 0.4 Bq / l and a global beta activity concentration of 0.06 Bq / l, in the groundwater sample taken in during 2020. Also in the same test, gamma radiation emitting radionuclides were below the detection limit (this limit is comparable to that indicated by Cernavodă NPP), and the activity concentration of C-14 was 0.026 Bq / g C, indicating an obvious separation of the source of carbon in deep water, compared to its atmospheric cycle. In June 2021, RATEN ICN Pitești took a sample of deep groundwater and performed activity determinations of radionuclides emitting alpha radiation (actinides), finding that there is no contamination of deep groundwater with this category of radionuclides, the evidence showing only the presence of uranium isotopes at levels compatible with those corresponding to the geological environment that hosts the body of water (according to the results presented in Chapter 3).

Conclusion: With regard to the deep groundwater sampled from the wells in the Cernavodă NPP site, the results obtained in the framework of the environmental radioactivity monitoring programme of the NPP, as well as the analyses carried out by ICSI Rm. Vâlcea and RATEN ICN Pitești, in 2020 and 2021, have shown that it is free of any radioactive contamination.

4.1.5 Qualitative radioactivity analysis for wet atmospheric depositions

At Cernavodă NPP, wet atmospheric deposition is monitored by monthly sampling from 5 locations, two of which are located off-site (SSS-03 Saligny, SSS-04 Cernavodă - Environmental Control Laboratory) and three on-site (SSS-09 DICA, SSS-17 Site U1-U2 and SSS-19 DIDSR). In 2020, the tritium activity concentration, for the sites SSS-03 and SSS-04 ranged from 3.3 Bq/l to 488 Bq/l, with an average of 114 Bq/l; and for sites SSS-09, SSS-17 and SSS-19, the specific tritium concentration ranged from 33 Bq/l to 4990 Bq/l, with an average of 525 Bq/l. The overall beta global activity concentration for all samples taken was in the same range as in previous years, with an average value of 0.16 Bq/l.

In the monitoring carried out by ICSI Rm. Valcea and RATEN ICN Pitești wet deposition sampling was undertaken in two locations, in Cernavodă. Thus, for the test of humid atmospheric deposits taken by ICSI on 04.09.2020, in the vicinity of the Yahoo hotel in Cernavodă, the activity concentration of tritium was 1.5 Bq / l. The results of the analyzes carried out by RATEN ICN on the sample of humid atmospheric deposits taken between 16.06 - 14.07.2021 from the LCM location, showed that the wet atmospheric deposits in the vicinity of the Cernavodă NPP are free of radioactive actinide contamination.

Conclusion: Both the results of the monitoring carried out by CNE Cernavodă, through the Environmental Radioactivity Monitoring Programme, and the results of the analyses carried out by ICSI Rm. Vâlcea and RATEN ICN Pitești, in 2020 and 2021, have shown that in the wet atmospheric deposition taken from the vicinity of the Cernavodă NPP tritium is the only radionuclide that could be detected, having its origin in gaseous effluent emissions from the NPP.

4.1.6 Qualitative physico-chemical analysis for domestic water

The domestic water network of the CTRF plant will be connected to the U1 network, which goes to the Cernavodă wastewater treatment plant and, following the treatment process, is discharged into the surface waters of the Danube. ICSI Rm. Vâlcea performed in 2020 a set of analysis in the same sampling location that was used for radiological indicators, respectively the domestic water collector in the vicinity of the Access Control Point from U1. The results obtained are shown in n Table 4.1.6.1 below.

Table 4.1.6.1 The results of physico-chemical analysis obtained for domestic water

Crt. no.	Physico-chemical indicators analyzed	Analysis method	Obtained results	NTPA limits (002)	No. of analysis report / Issuer
1.	pH (25 ° C)	SR EN ISO 10523/2012 PS-LACAFCAFC-13	6.8 upH	6,5 – 8,5 upH	136 / 05.11.2020 / ICSI Rm. Valcea
2.	Suspension matter	SR EN 872: 2005 PS-LACAFCAFC-07	85.0 mg/l	350 mg/L	
3.	Ammonium	SR EN ISO7150-1: 2001 PS-LACAFCAFC-16	26.42 mg/l ⁽²⁾	30 mg/L	
4.	Zinc	SR EN ISO 6332: 1996 / C91: 2006 PS-LACAFCAFC-DZN 09	<0.05 mg/l ⁽²⁾	1 mg/L	
5.	Biochemical oxygen consumption	PS-LACAFCA03-DCBO5-01 Ed 4, rev.0 / analysis kit: HACH-LANGE LCK555	20 mg O ₂ /l	300 mg/L	
6.	Chemical oxygen consumption	PS-LACAFCA03-DCCO5-Cr Ed 4, rev.0 / analysis kit: HACH-LANGE LCI 400	58.4 mg O ₂ /l	500 mg/L	
7.	Determination of detergents	PS-LACAFCA03-Detergents-01 Ed.2, rev. 0	0.139 mg/l	25 mg/L	
8.	Determination of total phosphorus	PS-LACAFCA03-DP-01 Ed 3, rev.0 / analysis kit: HACH-LCK348	2.95 mg/l	5.0 mg/L	
9.	Manganese	SR 8662-2 / 1996 PS-LACAFCAFC-DFCMN-05	<0.05 mg/l	2 mg/L	
10.	Determination of filtered residue at 105 ° C	STAS 9187-84 PS-LACAFCAFC-DRS-03	830 mg/l	-	

11.	Sulfides and hydrogen sulfide	SR EN ISO 10530/1997 PS-LACAFC-AFC-DSS-20	31.2 mg/l	1 mg/L
12.	Petroleum products from water samples	SR 7877-1: 1995	<10 mg/dm ³⁽³⁾	-
13.	Removable with organic solvents	SR 7587-1: 1996	<20 mg/dm ³⁽³⁾	30 mg/L
14.	Polycyclic aromatic hydrocarbons in water	SR EN ISO 17993/2004		
		Anthracene	0.0018 µg/l	
		Fluoranthene	0.0016 µg/l	
		Pyrene	0.0026 µg/l	
		Benzo anthracene	<0.0002 µg/l ⁽²⁾	
		Chrysene	0.0006 µg/l	
		Benzo (b) fluoranthene	0.00022 µg/l	
		Benzo (k) fluoranthene	<0.0005 µg/l ⁽²⁾	
		Benzo (a) pyrene	<0.0002 µg/l ⁽²⁾	
		Dibenzo (a, h) anthracene	<0.0002 µg/l ⁽²⁾	
		Benzo (g, h, i) perylene	<0.0005 µg/l ⁽²⁾	
		Indeno (1,2,3-cd) pyrene	<0.0002 µg/l ⁽²⁾	

Conclusion: Referring to the Government Decision no. 352/2005 regarding the modification and completion of the Government Decision no. 188/2002 for the approval of some norms regarding the conditions of discharge in the aquatic environment -The norm regarding the conditions of wastewater discharge in the sewerage networks of the localities and directly in the treatment plants, NTPA-002/2002, it is noted that the analyzed indicators did not exceed the maximum allowed limits. The potential of significant physico-chemical changes is also excluded in the case of sewage from the CTRF, as the average daily intake will be 2.90 m³, so there will be no significant changes compared to current discharges from U1.

4.2 Air environmental factor

Monitoring performed by NPP did not detect the presence of radioactive contaminants in the air, except for H-3 and C-14. For the analysis performed by ICSI Rm. Vâlcea and RATEN ICN Piteşti analysis locations in the vicinity of the source were selected (Cernavodă NPP premises: DIDSR, CTRF location, access control point) so as to identify potential sources of contamination. At the same time, samples were taken to monitor the radioactivity of the air in Cernavodă from the Environment Control Laboratory (representative location for the reference person in the population, considered in the assessments of the radiological impact on the health of the population).

4.2.1 Qualitative analysis from the point of view of radioactivity for the air environment factor

For the air environment factor, the Cernavodă NPP environmental monitoring program provides sampling for the following types of samples: aerosols (material particles in the air), iodine in the air, tritium in the air, carbon-14 in the air and humid atmospheric deposits.

During the year 2020, 140 aerosol samples were taken from 12 monitoring locations (11 indicator locations: ADI-02 to ADI-05, ADI-07 to ADI-13 and a reference location: ADB-01), the distance of

each monitoring location to the evacuation stack are shown in Table 4.2.1.1.

Table 4.2.1.1 The distance of aerosol sampling locations to the stack

Location code	Locality	Name	Location type	Distance (km)
ADI-02	Gherghina	Compet	Location Indicator	10
ADI-03	Medgidia	Weather Station	Location Indicator	20
ADI-04	Mircea Voda	Gara CFR	Location Indicator	10
ADI-05	Saligny	Gendarmerie unit	Location Indicator	1.5
ADI-07	Fetesti	Weather Station	Location Indicator	19
ADI-08	Cernavodă	Environmental Control Laboratory (LCM)	Location Indicator	2.5
ADI-09	Seimeni	Veterinary Dispensary	Location Indicator	8
ADI-10	Rasova	Police station	Location Indicator	11
ADI-11	Cernavodă	400 KV station	Location Indicator	0.8
ADI-12	Cernavodă	DIDSR	Location Indicator	0.2
ADI-13	Cernavodă	DICA	Location Indicator	0.5
ADB-01	Topalu	Police station	Reference Location	25

None of the samples collected showed gamma radiation emitting radionuclides above the detection limits of the analysis methods used (the values of the detection limits for all radionuclides considered were below the level of 5 mBq / m³). The analysis for determining the global beta activity concentration ranged from 0.1 to 1.9 mBq / m³ for the indicator locations, which were similar to the values recorded in the reference location, which were in the range of 0.3 - 1.8 mBq / m³. For the same set of samples, the concentrations of global alpha activity ranged from 0.02 to 0.25 mBq / m³. Thus, as the results of the environmental radioactivity monitoring program at Cernavodă NPP did not reveal, over time, by long term sampling, the presence in the air of other radionuclides, except tritium and C-14 (near the NPP), whose origin can be attributed to the operation of the plant [84], the analysis carried out for the purpose of this report had a smaller geographical extent (up to 6 km around the NPP, in the area where the magnitude of dispersion factors would allow the detection of radioactive pollutants).

During the set of analysis carried out by RATEN ICN Pitesti in June 2021, aerosol filters were taken from three locations on the site of Cernavodă NPP and a location in the city of Cernavodă (according to the results presented in Chapter 3). The analysis for the determination of the activity concentration of gamma emitting radionuclides did not reveal the presence of any radionuclide specific to the operation of NPP, above the detection limit. Also, **the recorded global beta activity concentrations were within the limits of variation due to the presence of natural radionuclides.**

At the same time, the study monitored the actinide content of aerosol samples. The analysis showed that on the site of Cernavodă NPP, and in its immediate vicinity, there is no actinide contamination of the air.

Tritium contamination of the air is monitored, within the environmental monitoring program of Cernavodă NPP, by monthly sampling from the same locations as those used for aerosol monitoring. In 2020, at monitoring stations located at distances greater than 10 km, values were recorded around the average of 0.12 Bq / m³, with a maximum value of 0.39 Bq / m³ registered at the ADI-03 station, in January. For the stations located at distances between 5 and 10 km, the tritium concentrations had annual average values in the range 0.23 - 0.33 Bq / m³, the maximum monthly value of 0.92 Bq / m³, being registered at the ADI-02 Gherghina station in February. In the case of off-site stations less than 5 km away, the average annual tritium concentration in the air was 0.98 Bq / m³, with a maximum of 2.18 Bq / m³ measured at the ADI-05 Saligny station, in February. For the 3 stations inside the exclusion zone (ADI-11 400 kV Station, ADI-12 DIDS and ADI-13 DICA), the values of tritium concentration in the air were between 0.61 Bq / m³ (ADI-13, in March, April, May) and 17.40 Bq / m³ (ADI-12, in January), with an average value of 4.72 Bq / m³ [84].

In the year 2020, within the analysis performed by ICSI Rm. Vâlcea, three samples were taken from the NPP site and one sample from the Environmental Control Laboratory in Cernavodă, in order to verify the level of tritium contamination of the air. Air activity concentrations for these samples ranged from 0.56 to 1.81 Bq / m³, confirming the results of the NPP monitoring program.

Carbon-14 in the air is monitored by Cernavodă NPP by monthly sampling in 3 locations, one of which is located on the NPP site (ADI-13) and two located offsite NPP (ADI-05 and ADI-08). For the samples taken from the ADI-13 location, located in the vicinity of DICA, the maximum concentration of C-14 in the air was 42 mBq / m³, being recorded in August, and the annual average was 27 mBq / m³. For off-site locations, the maximum airborne C-14 concentration was 7 mBq / m³, recorded at the ADI-08 LCM location in September, and the annual average was 4 mBq / m³ at the ADI-08 location and 3 mBq / m³ at the ADI-05 location [84]. The study conducted in 2020 by ICSI Rm. Vâlcea provided for 3 samples from the NPP site and one from the LCM location, to determine the activity concentration of C-14 in the air. The results of the analysis, presented in Chapter 3, were in the range of 43 - 47 mBq / m³. These values are slightly higher than the annual averages obtained in the NPP monitoring program, but correspond to the reference level of 238 Bq / kg C [97], of the concentration of C-14 activity in the carbon involved in the atmospheric cycle (contaminated from the cosmogenic source).

The operation of the Cernavodă NPP tritium removal facility will ensure a significant positive impact on the doses of NPP personnel, especially on those who carry out maintenance activities in the plant's facilities, but also a major effect of reducing tritium emissions in effluents, for both normal situations and accident situations. However, the operation of the CTRF involves the release of radioactive effluents into the environment as a result of technological operations applied under normal operating conditions.

In the report 79-38500-TR-CTRF 001, edition 2014- Evaluation of Tritium Release for CTRF Normal Operation, tritium emissions are estimated under normal operating conditions of the CTRF installation as follows:

- Tritium emission in the form of molecular gas DT (HT) = 17 TBq / year;
- Tritium emission in the form of oxidized DTO (HTO) = 33 TBq / year; and
- The total tritium emission is 50 TBq / year.

These emission estimates fall within the range of values found in other similar installations, correspondingly related to the amount of heavy water processed. The Darlington - Canada (DTRF) tritium removal facility processes the largest amount of tritiated water from a civilian facility in the world and stores 1-2 kg of tritium per year. Based on the experience of this installation, considering the operational limit of 54 Ci / kg established for the concentration of tritium activity at the CTRF supply, results in a predicted emission of 50 TBq / year for DT and DTO (<0.01% of the processed material). The Wolsong - Korea detritiation plant (WTRF) is

designed to process 100 kg / hour of tritiated water with a tritium extraction efficiency > 97%, with an operating capacity of 80% and a lifespan of 40 years. This plant is technologically similar to the proposed CTRF, applying the same procedures for LPCE isotope exchange, CDS cryogenic distillation, and TGHS titanium / uranium storage. Through the WTRF project the heavy water losses are limited to 0.1 kg / day representing 0.004% of the daily processed quantity, using these figures the loss to CTRF can be estimated at 0.04 kg / day. Taking into account the technological limit imposed for CTRF, regarding the maximum activity concentration of tritium in the fed heavy water, an emission of maximum 27 TBq / year is estimated, a lower value than the one indicated by the designer.

Starting from the planned emissions presented above and applying the calculation model established for the limits derived from Cernavodă NPP, we can estimate that, if the emissions were exclusively in gaseous form, the effective dose for the representative of the population would be less than 0.7 microSv / year. Similarly, if the emissions of tritium in oxidized form were to be achieved exclusively by liquid effluents, the effective dose for the representative person in the population would be less than 0.4 microSv / year.

In view of the above, the establishment of a dose constraint associated with the operation of CTRF of 10 microSv / year is a sufficiently relaxed margin to regulate the emissions of the tritium removal facility. The fractionation of this constraint in relation to the emission routes will be updated, based on the accumulation of experience in operation, initially recommending the application of a fractionation similar to that used by NPP (75% for gaseous emissions and 25% for liquid emissions).

4.2.2 Physico-chemical qualitative analysis for the air environment factor

The physico-chemical analysis of the air environmental factor was carried out on the basis of the sources likely to produce non-radioactive emissions (diesel-generator back-up units and transport activities for waste disposal and diesel fuelling of the two generators), which involved calculating dispersion factors and transposing them into spatial distribution maps of pollutant concentrations.

All these analyses, as well as the impact assessment, are detailed in Chapter 5.

4.3 Soil environmental factor

4.3.1 Qualitative analysis from the point of view of radioactivity for the soil environmental factor

Soil environment factor is radiologically monitored, within the environmental monitoring program from Cernavodă NPP, by biannual sampling from 7 locations (LDI-01 Mircea Vodă (10.6 km E-SE), LDI-02 Seimeni (8.3 km N), SSL- 01 DICA (650 m E-NE), SSS-10 U1, SSS-11 Cernavodă - viticultural farm (2.3 km SE), SSS-12 LCM (2.5 km NW) and SSS-13 Topalu (25 km N). In 2020, the concentrations of global beta activity in the samples taken from the indicator locations were in the range of 325 - 410 Bq / kg, which were similar to the values recorded in the reference location (SSS-13). Gamma spectrometry analysis revealed the presence of natural series radionuclides and Cs-137. The activity concentrations of Cs-137 were between 1.2 and 6.8 Bq / kg, the level at which this radionuclide is present in the soil as a result of the Chernobyl accident. The tritium activity concentrations in the soil samples were in the range of 0.5-42.5 Bq/kg [84]. Based on the results of the program for monitoring the radioactivity of the environment, which showed that, in terms of soil in the area 30 km around the NPP, no radioactive contamination was detected over time, as a result of atmospheric deposits originating from radionuclides released into the environment by the NPP. The studies conducted for the purpose of this report focused on the area in the immediate vicinity of the two functioning units seeking a comparison and completion of the results of the monitoring so that the results can be used for impact analysis.

The analysis performed by ICSI Rm. Vâlcea in 2020 followed the radiological characterization of a set of four soil samples to determine: the concentration of global beta activity, the concentration of radionuclides emitting gamma radiation and the concentration of tritium in free water present in samples (Table 4.3.1.1).

Table 4.3.1.1 Radiological characterization of soil samples - 2020

Sampling location	LCM	PCA	DIDSR	CTRF
No. of analysis report	140 / 05.11.2020	141 / 05.11.2020	142 / 05.11.2020	143 / 05.11.2020
H-3 activity concentration (Bq / kg)	2.4 ± 0.3	19.6 ± 2.0	17.3 ± 3.5	10.6 ± 2.8
Global beta activity concentration (Bq / kg)	588.30 ± 121.26	555.64 ± 114.75	592.45 ± 121.89	534.02 ± 110.56
Gamma emitting radionuclide activity concentration (Bq / kg)	SLD * 5.24 **	SLD * 1.62 **	SLD * 1.98 **	SLD * 3.03 **

*SLD- below the detection limit. The limit of detection was calculated for a number of Cernavodă NPP specific gamma-emitting radionuclides and is specified in the analysis reports

** The measured value of the Cs-137 radionuclide activity concentration is indicated

It is observed that the values determined by ICSI Rm. Vâlcea are comparable to those registered in the environmental monitoring program of NPP Cernavodă.

The radiological characterization presented above was completed by the analysis performed in 2021 by RATEN ICN Pitești to determine the concentration of actinide activity in soil samples (Table 4.3.1.2). For this purpose, soil samples were taken from the same locations used by ICSI (LCM, PCA, DIDR and CTRF), and the sampled material was mixed and sampled in the laboratory and subjected to the radioanalytical procedure.

Table 4.3.1.2 Radiological characterization of soil samples - 2021

Measured parameter / Soil - composite sample	Result	Measurement report/ issuer
Activity concentration Pu-239/240 (mBq / g)	<0.5	824 / 19.10.2021 RATEN ICN Pitesti
Activity concentration Pu-238 (mBq / g)	<0.5	
Activity concentration Am-241 (mBq / g)	<1.2	
Activity concentration U-238 (mBq / g)	30.5 ± 3.2	
Activity concentration U-235 (mBq / g)	2.6 ± 1.0	
Activity concentration U-234 (mBq / g)	33.7 ± 3.4	

The results of the analysis show that the isotopes of the transuranic elements, the only radionuclides in the category of actinides present in the samples, being the isotopes of natural uranium, at concentrations at which they are naturally distributed in the soil, could not be detected [97].

Conclusion: Both the results of the monitoring carried out by CNE Cernavodă, through the Environmental Radioactivity Monitoring Programme, and the results of the analyses carried out by ICSI Rm. Vâlcea and RATEN ICN Pitești, in 2020 and 2021, have shown that the soil in the vicinity of Cernavodă NPP does not present radioactive contamination, the only gamma-emitting radionuclides detected in the samples being those of the natural series and Cs-137 (present as a result of the Chernobyl accident). Water extracted from soil samples also contains tritium, originating from wet atmospheric deposition.

4.3.2 Qualitative analysis from a physical - chemical point of view for the soil environmental factor

From a non-radioactive point of view, it has been assumed that the soil in the CTRF site area may be contaminated from possible leaks of fuels and oils from domestic transport, washing / cleaning equipment, handling and storage of fuels.

Therefore, the hydrocarbons content was measured from 3 representative soil samples (see Table 4.3.2.1 below) taken from the site surface. Monitoring activities have not been extended to the 30 km area, as the potential for Cernavodă NPP contamination resulting from fuel and oil leaks is limited by NNP administrative measures and procedures for the management of hazardous substances. The equipment and the internal means of transport, serve only within the NPP.

Table 4.3.2.1 Qualitative analysis of the soil environmental factor from the point of view of hydrocarbons contamination

Sampling location	Result	Measurement report/ issuer
Soil PCA	<1000 mg / kg dry matter	141 / 05.11.2020 / ICSI Rm. Vâlcea
Soil DIDR	<1000 mg / kg dry matter	142 / 05.11.2020 / ICSI Rm. Vâlcea
Soil CTRF	<1000 mg / kg dry matter	143 / 05.11.2020 / ICSI Rm. Vâlcea

CONCLUSION: The results obtained were below the limit of the measurement method, of 1000 mg / kg. Referring to the maximum values permitted by Order 756 of 1997, it is noticeable that the results obtained for the 3 determinations, show values below the threshold of 1000 mg / kg, corresponding to less sensitive soils.

The potential of the soil environmental factor to be damaged under normal operation of the CTRF plant, along with with the implementation of appropriate measures for the prevention and avoidance of hydrocarbons spills, presented in Chapter 7, is excluded. This is also supported by the impact analysis detailed in Chapter 5.

4.4 Biodiversity

4.4.1 Qualitative radioactivity analysis for biodiversity

The assessment of the impact of the CTRF project on the fauna and flora was made in relation to the effect of reducing the emission levels of U1 and U2 of Cernavodă NPP, along with reducing the tritium inventory in the moderator systems and in the primary heat transport systems from the two reactors.

The analysis performed to assess the impact on biodiversity as a result of the activities on the Cernavodă NPP platform were carried out in previous periods, one of them being included in „*Studiul impactului funcționării Centralei Nucleare-electrice de la Cernavodă asupra organismelor acvatice și terestre din zona de influență a acesteia*” (Study of the impact of the operation of the Cernavodă Nuclear Power Plant on aquatic and terrestrial organisms in its area of influence), Made by ICSI Rm. Vâlcea during 2009-2011. In terms of assessing the radiological impact on fauna and flora, the study included monitoring and evaluation of radiation exposure of some species of aquatic and terrestrial organisms, using the methodologies described in COG research reports. Thus, with regard to the estimated doses for endemic fish species, it has been established that under the date of the study, the total absorbed dose does not exceed 12 microGy / year, primarily due to tritium and C14, radionuclides derived from the operation of NPP, but also K-40 and Cs-137, whose presence in the environment at the present concentration levels cannot be related to the activity of NPP. The terrestrial organisms for which exposure assessments were performed were the field mouse and the common deer, for which the estimated absorbed doses were less than 10 microGy / year. In terms of risk characterization, the estimated doses for both terrestrial and aquatic organisms have been reported at the reference levels recommended by

the Canadian Nuclear Safety Commission, in the form of ENEV (expected no effect values), resulting in risk indices of order 5×10^{-5} for aquatic biota and 4×10^{-3} for terrestrial biota [86]. This shows that the releases of radioactivity into the environment from Cernavodă NPP are still far from producing detectable effects on the fauna and flora in the area of influence.

Monitoring the impact of the operation of the Cernavodă NPP on aquatic and terrestrial biota, carried out by ICSI Rm. Vâlcea, continued over the period 2012 - 2016, and the results showed that in 2016, the tritium concentration in environmental samples showed similar values to those recorded in previous monitoring periods, with the distribution of these values depending on the distance from the source. As a general conclusion it is stated in the annual report of the monitoring project for 2016, that the values measured in all types of samples confirm that the environment is undisturbed, in all monitored locations the natural level is met, except for the exclusion zone [98].

As the area in the immediate vicinity of the Cernavodă NPP site is heavily anthropized, biodiversity is monitored as part of the environmental monitoring program, especially with regard to the elements of agricultural ecosystems, having as main purpose the radiological characterization of the elements considered for dose assessment in the population. The only elements of the natural ecosystems that are likely to be affected by NPP activities that are systematically monitored are spontaneous vegetation and fish from the Danube.

The results of the radiological monitoring of spontaneous vegetation, carried out in 2020, showed that the average value of the global beta activity concentration in the 24 samples taken was 120 Bq / kg, with a maximum of 234 Bq / kg recorded in the SSS- 12 (Topalu - reference location) in September. No gamma radiation emitting radionuclides other than natural ones were detected, their levels being similar to the levels recorded in previous monitoring periods. The concentration of tritium activity in the spontaneous vegetation on the NPP and DICA site (locations SSL-01 - DICA and SSS-10 - Unit1) was on average 597 Bq / kg, with a maximum value of 1840 Bq / kg recorded in the vicinity of U1 in October. The values of the tritium activity concentration in the off-site control location (SSS-13 - LCM) were distributed around the average of 76 Bq / kg, with a maximum value of 156 Bq / kg, recorded in September. The concentration of C-14 activity in the spontaneous vegetation on the NPP site had values distributed in the range of 271 - 492 Bq / kg C, their average being 353 Bq / kg C. The values of the C-14 concentration in the spontaneous vegetation taken from the indicator location from LCM were comparable to those recorded in the reference location, averaging 255 Bq /kg C [84].

Measurements made by ICSI Rm. Vâlcea in 2020 included the radiological characterisation of a sample of spontaneous vegetation from the CTRF site, and the results are presented in Table 4.4.1.1.

Table 4.4.1.1 Radiological monitoring for spontaneous vegetation - 2020

Determined parameter / CTRF spontaneous vegetation	Result	Measurement report/ issuer
H-3 activity concentration (Bq / kg fw)	171.5 ± 8.7	148 / 05.11.2020 ICSI Rm. Vâlcea
OBT activity concentration (Bq / l water comb.)	372.1 ± 23.3	
C-14 activity concentration (Bq / g C)	0.341 ± 0.022	
Global beta activity concentration (Bq / kg dw)	846.02 ± 157.99	
Gamma emitting radionuclide activity concentration (Bq / kg)	SLD *	

*SLD- below the detection limit. The limit of detection was calculated for a number of Cernavodă NPP specific gamma-emitting radionuclides and is specified in the analysis reports

It is observed that the results of the analysis performed by ICSI Rm. Vâlcea in 2020 are comparable to those obtained in the plant's monitoring program.

The level of contamination with alpha-emitting radionuclides (actinides) of the spontaneous vegetation from the CTRF location was determined by RATEN ICN Pitești, based on the analysis of a sample taken in June 2021. The results of the analysis are presented in Table 4.4.1.2.

Table 4.4.1.2 Radiological monitoring for spontaneous vegetation - 2021

Measured parameter / CTRF spontaneous vegetation	Result	Measurement report/ issuer
Pu-239/240 activity concentration (mBq / g)	<0.3	825 / 19.10.2021 RATEN ICN Pitesti
Pu-238 activity concentration (mBq / g)	<0.3	
Am-241 activity concentration (mBq / g)	<0.2	
U-238 activity concentration (mBq / g)	0.8 ± 0.3	
U-235 activity concentration (mBq / g)	<0.3	
U-234 activity concentration (mBq / g)	0.4 ± 0.2	

Assessing the impact of the CTRF project on fauna and flora

Based on the results of the tritium and C-14 concentration analysis, as well as the beta-global and gamma-spectrometric activity concentration analysis, (momentary) values of global beta activity concentrations and tritium are indicated, which are lower than the average of the values of the corresponding parameters, from the environmental radioactivity monitoring programme carried out by the Cernavodă NPP. **Analysis for the determination of the activity concentration of gamma radiation emitting radionuclides did not reveal the presence of NPP-specific anthropogenic radionuclides in: surface waters, meteoric water, environmental factors air, soil and biodiversity in the area of influence of Cernavodă NPP, these being at the level of the natural background.** The results obtained in the environmental monitoring program from Cernavodă NPP, as well as previous studies on the impact of activities on the NPP platform on the environment showed that the only radionuclide from the operation of the plant, which can be detected outside its location is tritium, and the area in which its concentration in environmental factors may have values above the background level has a maximum radius of 10 km. It was also shown that the impact of the presence of tritium on the flora and fauna present around the Cernavodă NPP, at the levels induced by the emissions from the plant, is insignificant, the estimated dose values being in lower order of magnitude than the reference levels (ENEV – expected no effect value) [86].

Additionally, the physico-chemical contaminants from the spontaneous vegetation cannot be attributed to the specific activity of Cernavodă NPP.

Based on these results, we **evaluate the impact of the CTRF project (whose objective is to reduce the tritium inventory in the active circuits of the plant and, reduce the radioactive emissions in the environment) on the fauna and flora of at least 30 km around Cernavodă NPP as negligible.**

In the perimeter of the zone of influence (Zdl) with a radius of 30 km were reported in the Standard Forms Natura 2000, accessed on the <http://www.mmediu.ro/articol/natura-2000/435> website, 17 habitats of Community interest. Of these, 3 have the status of habitats of priority conservation interest:

- 91AA * Ponto-Sarmatic forest vegetation with downy oak / Eastern white oak forests, found in the following sites: ROSCI0022 Canaralele Dunării , ROSCI0071 Dumbrăveni-Valea Urluia - Lacul Vederoasa and ROSCI 0172 Pădurea și Valea Canaraua Fetii - Iortmac
- 62C0 * Ponto-Sarmatic steppes, found in 5 of the sites: ROSCI0022 Canaralele Dunării , ROSCI0053 Dealul Allah Bair, ROSCI0071 Dumbrăveni-Valea Urluia-Lacul Vederoasa, ROSCI 0172 Pădurea și Valea Canaraua Fetii-Iortmac and ROSCI0278 Bordușani – Borcea;
- 40C0 * Ponto-Sarmatic deciduous bushes / Ponto-Sarmatic deciduous bushes that are distributed on the surface of the sites: ROSCI0022 Canaralele Dunării , ROSCI0071 Dumbrăveni-Valea Urluia - Lacul Vederoasa and ROSCI 0172 Pădurea și Valea Canaraua Fetii - Iortmac;

we evaluate the impact of the CTRF project as neutral.

In the case of the 8 plant species of Community conservation interest reported in the 30 km zone of influence (Zdl):

1. 2236 *Campanula romanica*,
2. 2253 *Centaurea jankae*,
3. 6927 *Himantoglossum jankae*,
4. 1428 *Marsilea quadrifolia*,
5. 2079 *Moehringia jankae*,
6. 6948 *Pontechium maculatum subsp. maculatum*,
7. 2125 *Potentilla emilii-popii*
8. 2093 *Pulsatilla grandis* -.

we evaluate the impact of the CTRF project as neutral.

In the case of the 10 invertebrate species of Community conservation interest reported in the 30 km zone of influence (Zdl):

1. 4056 *Anisus vorticulus*,
2. 4028 *Catopta thrips*,
3. 1088 *Cerambyx cerdo*,
4. 1074 *Eriogaster catax*,
5. 6169 *Euphydryas maturna*,
6. 6199 *Euplagia quadripunctaria*,
7. 1083 *Lucanus cervus*,
8. 1060 *Lycaena dispar*,
9. 4053 *Paracaloptenus caloptenoides*,
10. 4043 *Pseudophilotes bavius*.

we evaluate the impact of the CTRF project as neutral.

In the case of the 15 fish species of Community conservation interest reported in the 30 km area of influence (Zdl):

1. 14691 *Alosa immaculata*,
2. 4127 *Alosa tanaica*,
3. 1130 *Aspius aspius*,
4. 6963 *Cobitis taenia Complex*,
5. 2484 *Eudontomyzon mariae*,
6. 2555 *Gymnocephalus baloni*,
7. 1157 *Gymnocephalus schraetzer*,
8. 1145 *Misgurnus fossilis*,
9. 2522 *Pelecus cultratus*,
10. 5339 *Rhodeus amarus*,
11. 6143 *Romanogobio kesslerii*,
12. 5329 *Romanogobio vladykovi*,
13. 5347 *Sabanejewia bulgarica*,
14. 1160 *Zingel streber*,

15. 1159 *Zingel zingel*

we evaluate the impact of the CTRF project as neutral.

In the case of the 2 species of amphibians of Community conservation interest reported in the zone of influence (Zdl) of 30 km:

1. 1188 *Bombina bombina*,
2. 1993 *Triturus dobrogicus*,

we evaluate the impact of the CTRF project as neutral.

In the case of the 4 species of reptiles of Community conservation interest reported in the zone of influence (Zdl) of 30 km:

1. 5194 *Elaphe sauromates*,
2. 1220 *Emys orbicularis*,
3. 1219 *Testudo graeca*,
4. 1217 *Testudo hermanni*

we evaluate the impact of the CTRF project as neutral.

In the case of the 9 species of mammals of Community conservation interest reported in the 30 km zone of influence (Zdl):

1. 1355 *Lutra lutra*,
2. 2609 *Mesocricetus newtoni*,
3. 1310 *Miniopterus schreibersii*,
4. 1321 *Myotis emarginatus*,
5. 1304 *Rhinolophus ferrumequinum*,
6. 1303 *Rhinolophus hipposideros*,
7. 1302 *Rhinolophus mehelyi*,
8. 1335 *Spermophilus citellus*,
9. 2635 *Vormela peregusna*

we evaluate the impact of the CTRF project as neutral.

In the case of the 169 bird species reported in the 30 km zone of influence (Zdl) of which 70 are of Community conservation interest and are found in Annex 1 of the Birds Directive (ANNEX 1), we assess the impact of the CTRF project as neutral.

4.5 Climate and climate change

The predicted risks of extreme weather events during the operation of the CTRF plant were taken from the Study "Services for the analysis of recorded historical data and forecasts required for the systematic characterization of external hazards of natural origin applicable to Cernavodă NPP site (79/82-01551-AR-022)" [25], which includes the climate change forecast made by ANM in November, 2018, based on historical meteorological data.

For the forecast of extreme weather events likely to occur in the area of the CTRF site, ANM used the Representative Concentration Pathway (RCP) climate scenarios 4.5 and 8.5.

These scenarios have been developed by the Intergovernmental Panel on Climate Change (IPCC) since 2007 and published in 2014 in the 5th Assessment Report [104]. The name of these scenarios was determined according to the variation in solar radiation levels caused by climate change (so-called radiative forcing) which is assumed to stabilise by 2100.

Basically, the scenarios mostly take into account the amount of greenhouse gases that will be generated by the year 2100, which could increase the radiative forcing to a specific value, further warming the earth's surface. Thus, a higher value of radiative forcing will lead to a more pronounced warming of the earth's surface.

It should be noted that RCP scenarios do not take into account socio-economic scenarios, but they are consistent with several types of socio-economic developments, as different future socio-economic changes could lead to similar changes in atmospheric greenhouse gas concentrations [100].

The following briefly describes some characteristics of the two climate scenarios taken from the ANM study [25] for forecasting the probability of extreme weather events.

The RCP 4.5 scenario is a long-term scenario that takes into account estimates of global greenhouse gas emissions capable to stabilize radiative forcing at 4.5 W/m^2 by the year 2100 [102]. This value of radiative forcing is equivalent to an emission of 650 ppm CO_2 . This amount of CO_2 is considered to be moderate.

One of the advantages of using RCP 4.5 in climate change prediction studies is the possibility to compare its results with those of similar models that exist in large numbers in the literature.

RCP 4.5 is a stabilisation scenario and assumes that climate policies, in this case the introduction of a set of global greenhouse gas emission prices, are used to achieve the objective of limiting emissions and radiative forcing [101].

The RCP 8.5 scenario considers assumptions such as rapid population growth and relatively slow income growth with modest rates of technological change and improvements in energy intensity, leading in the long term to high energy demand and GHG emissions in the absence of climate policies [102]. RCP 8.5. corresponds to the scenario with the highest GHG emissions, which is assimilated to a radiative forcing at the year 2100 of 8.5 W/m^2 .

4.5.1 Predicted risks of heat waves

Global climate change will cause an increase in temperatures in the geographical area of Romania and thus the longer persistence of heat waves [87]. A climatic parameter associated with the presence of heat waves is represented by the extreme maximum temperatures of the hot season.

To determine the risks of extreme temperatures associated with heat waves, the maximum annual temperature data were used, with different probabilities for the Cernavodă area taking into account the RCP 4.5 climate scenario covering a moderate increase in temperatures for the period between 2018-2057 (Table 4.5.1.1).

Table 4.5.1.1 Maximum annual temperature (in $^{\circ}\text{C}$) with different probabilities, and respective return periods, in the Cernavodă area (with data from the simulations in the conditions of the moderate increase of the greenhouse gas concentration - RCP 4.5) covering the period of 40 years (2018 -2057) [25]

Probabilities (%)	20	10	5	2	1	0.5
Return periods (years)	5	10	20	50	100	200
CLM	42,96	43,84	44,51	45,14	45,48	45,74
HIRHAM5	36,91	37,82	38,59	39,46	40,04	40,59
RACMO	38,14	39,12	40,0	41,05	41,78	42,48
REMO	41,53	42,85	44,09	45,72	46,96	48,22
WRF	38,42	39,05	39,55	40,04	40,32	40,54
RCA4-ICHEC	40,78	41,80	42,68	43,70	44,40	45,06
RCA4-IPSL	41,82	42,83	43,67	44,56	45,11	45,56
RCA4-MPI	43,08	44,10	44,97	45,94	46,58	47,14

Remark: CLM – Climate Limited-area Modelling (Model climatic);
 HIRHAM5 - High-Resolution Hamburg Climate Model 5 (Model climatic);
 RACMO - Regional Atmospheric Climate Model (Model climatic);
 REMO - Max Planck Institute Regional Model (Model climatic);
 WRF - Weather Research and Forecasting Model (Model climatic);
 RCA4-ICHEC - Rossby Center Regional Atmospheric4 - Irish Centre for High-End Computing Model (Model climatic);
 RCA4-IPSL - Rossby Center Regional Atmospheric4 - Institut Pierre Simon Laplace Model (Model climatic);
 RCA4-MPI - Rossby Center Regional Atmospheric4 – Max Planck Institute for Meteorology Model (Model climatic).

A worst case scenario (RCP 8.5 climate scenario) was also taken into account, which takes into account a significant increase in greenhouse gases (shown in Table 4.5.1.2 below).

Table 4.5.1.2 Maximum annual temperature (in °C) with different probabilities, and respective return periods, in the Cernavodă area (with data from the simulations in the conditions of the worst case scenario of increasing the concentration of greenhouse gases - RCP 8.5) covering the period of 40 years 2018 -2057) [25]

Probabilities (%)	20	10	5	2	1	0.5
Return periods (years)	5	10	20	50	100	200
CLM	43,95	44,71	45,18	45,58	45,77	45,90
HIRHAM5	36,29	37,73	39,23	41,31	42,95	44,65
RACMO	39,27	40,10	40,72	41,38	41,79	42,15
REMO	42,02	43,46	44,88	46,73	48,12	49,50
WRF	39,52	40,46	41,26	42,12	42,66	43,11
RCA4-ICHEC	40,84	42,12	43,36	44,95	46,15	47,34
RCA4-IPSL	42,10	42,80	43,39	44,05	44,51	44,92
RCA4-MPI	42,34	43,28	44,08	45,00	45,62	46,19

The 2 scenarios were completed with a complementary analysis regarding the average increase of the monthly average value of the maximum daily temperature in the period 2018-2057 compared to 1971-2010 under the conditions of the 2 scenarios mentioned above (Figure 4.5.1.1.- 4.5.1.2).

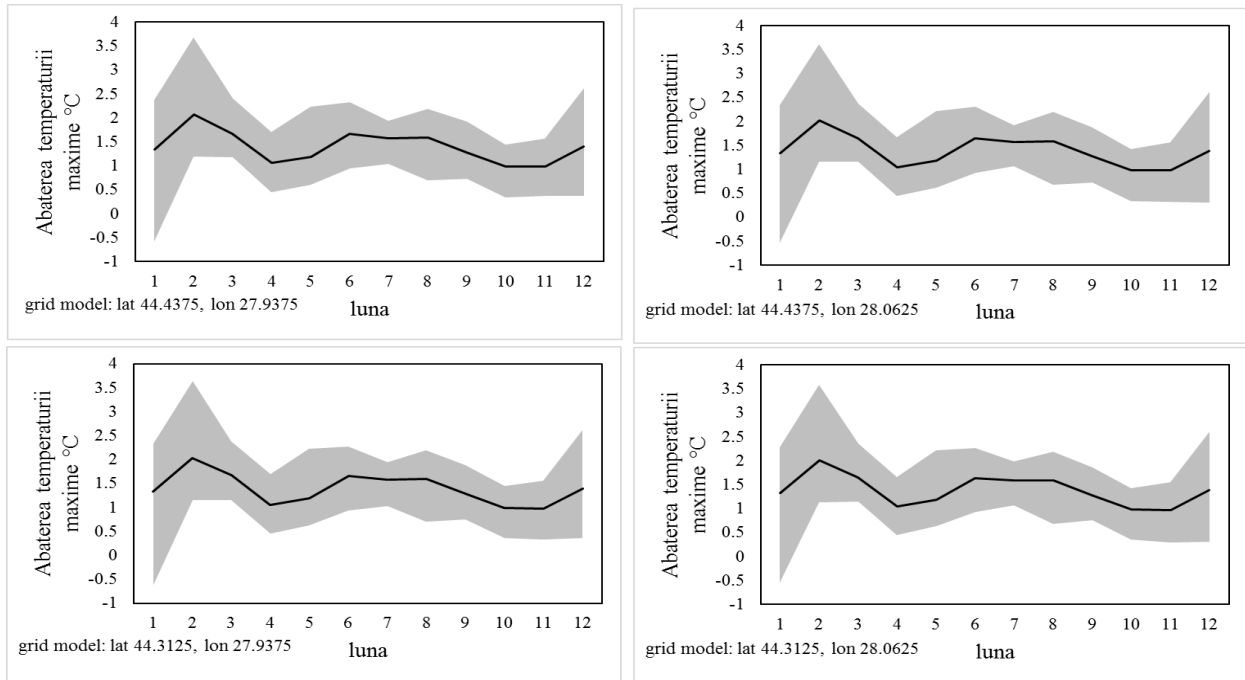

**(Deviation of the maximum temperature, month)*

Figure 4.5.1.1 The average increase of the monthly average value of the maximum daily temperature in the period 2018-2057 compared to 1971-2010, under the conditions of the RCP 4.5 scenario.

In the period 2006-2010, included in the reference period 1971-2010, results were used under the conditions of the RCP 4.5 scenario. The gray line represents the range of values of the set of regional models used, and the black line is the average value of this set [25].

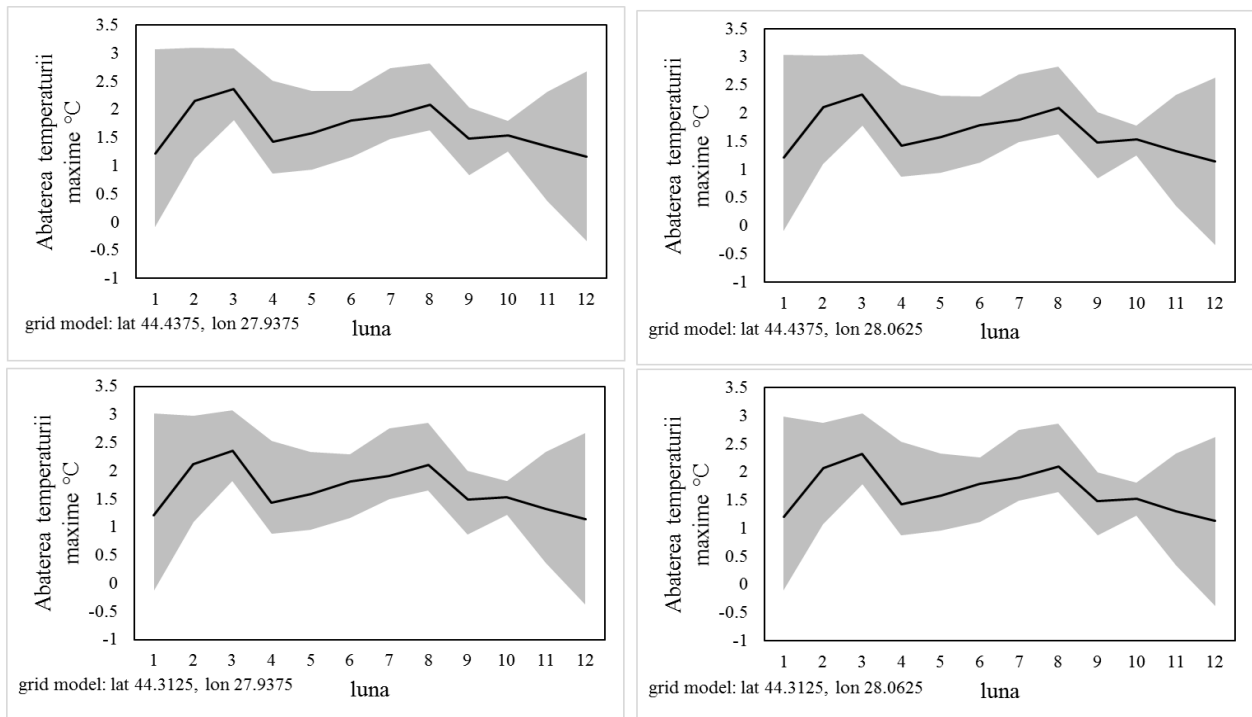

**(Deviation of the maximum temperature, - month)*

Figure 4.5.1.2 The average increase of the monthly average value of the maximum daily temperature in the period 2018-2057 compared to 1971-2010, under the conditions of the RCP scenario 8.5

In the period 2006-2010, included in the reference period 1971-2010, results were used under the conditions of the RCP 4.5 scenario. The gray line represents the range of values of the set of regional models used, and the black line is the average value of this set [25].

The analysis of the results provided by the 2 climate scenarios, identified an average increase associated with the monthly average value for the maximum daily temperature of 1°C and 2°C for the period 2018-2057 compared to 1971-2010 under the conditions of the RCP 4.5 scenario and 1°C and 2.5°C under the RCP 8.5 scenario. It is worth noting that the level of uncertainty of the models is higher in the cold season months [25].

In terms of maximum temperature, one of the numerical experiments simulates that the absolute maximum daily temperature, in the case of the worst case RCP 8.5 scenario, will reach 49.50°C in the region of interest (in one month of August of the period 2018-2057) (Table 4.5.1.2).

The values of the maximum temperature at the same probability and the return period are higher in the case of the 2 scenarios, compared with the measured historical period. The differences between the 2 scenarios are not significant in the studied time horizon.

Thus, the possible increase in maximum temperature also suggests a higher probability of increasing the frequency and duration of heat waves and thus an increased risk of this phenomenon for the site area.

The information provided by the ANM report was completed by the results of a study conducted for the Central European area, where the region of our country is located, whose main theme was the analysis of future scenarios regarding the characteristics of heat waves. Thus, after analysing the results of the ENSEMBLES and EURO-CORDEX projects, the following conclusions were reached [88]:

- Following simulations of the near future (2020–2049), it is estimated that the number of heat waves will be almost twice as high as in the period 1970-1999, while the frequency of severe heat waves will increase by 2 to 3 times.
- For the period 2070-2099 it is estimated that 2 severe heat waves will be recorded every summer, this becoming a regular phenomenon.
- The vast majority of simulation models require the recording of at least one extreme heat wave every 10 years.

4.5.2 Predicted risks of drought

From the analysis of the data presented in recent specialized studies [15], it is concluded that the maximum number of days of drought in the cold season, for 1% assurance, varies from 58 days in Fetești, up to 100 days in Medgidia. In the case of the hot season, the same parameter varies from 72 days in Cernavodă to 86 days in Fetești (Table 4.5.2.1).

Table 4.5.2.1 Maximum number of days of drought with various probabilities of occurrence [15]

Weather station	Cold season				Warm season			
	Assurance (%)				Assurance (%)			
	1	2	5	10	1	2	5	10
Cernavodă	64	57	49	32	72	64	53	44
Medgidia	100	86	78	54	80	71	58	49
Fetești	58	52	44	38	86	76	63	53

Regarding the projected risk of drought during operation, this was analysed by ANM in the same study mentioned above using the simulated values of the Palmer Index of Drought Severity, in standardized units, until the year 2100. It took into account both the moderate climate scenario RCP 4.5 (Figure 4.5.2.1), as well as the worst case climate scenario RCP 8.5 (Figure 4.5.2.2).

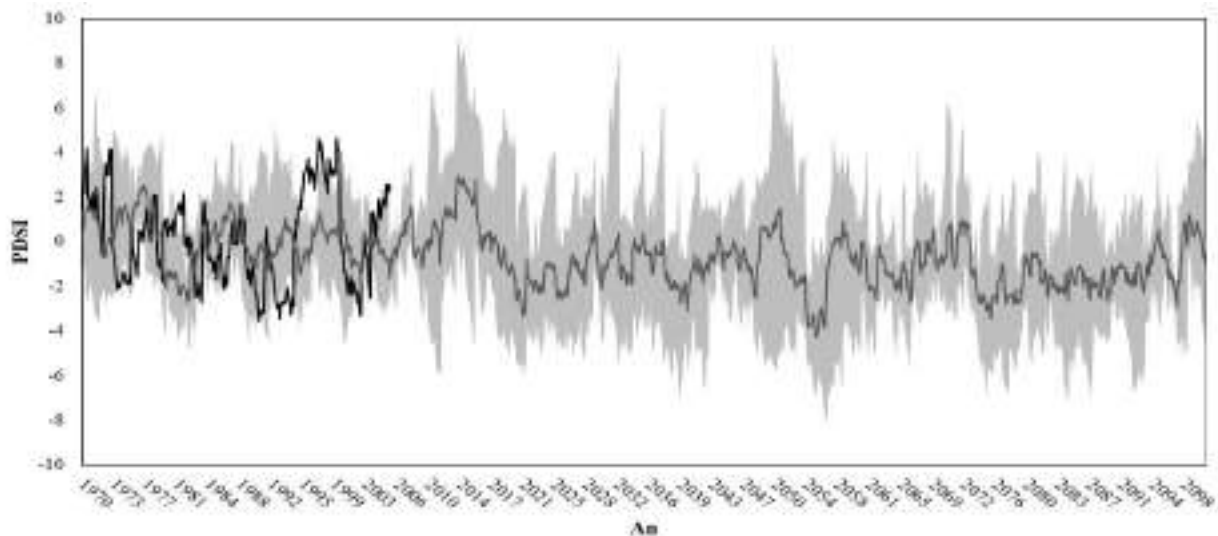

Figure 4.5.2.1 The evolution of the Palmer Index of Drought Severity (in standardized units) observed (1970-2005; black line), simulated (1970-2005): gray band and gray line representing all regional models used) and projected into the future (2006-2100; gray band and gray line representing all regional models used), the climate scenario used is moderate (RCP 4.5) [25]

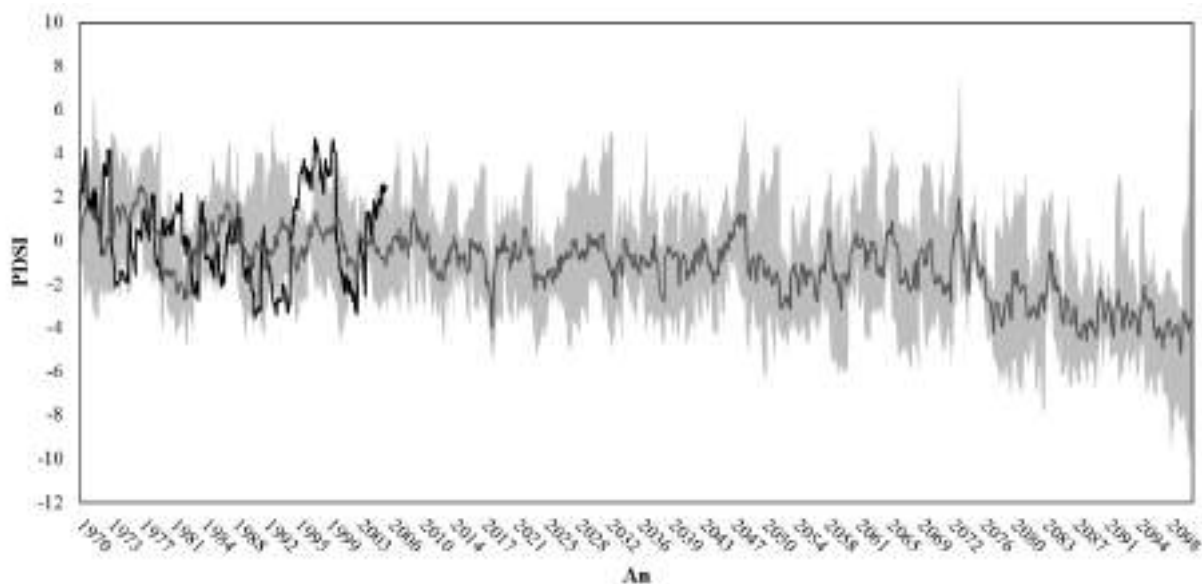

Figure 4.5.2.2 The evolution of the Palmer Index of Drought Severity (in standardized units) observed (1970-2005; black line), simulated (1970-2005: gray band and gray line representing all regional models used) and projected into the future (2006-2100; gray band and the gray line representing all regional models used), the climate scenario used is the worst case one (RCP 8.5) [25]

In the Palmer classification, values below -4 illustrate extreme droughts, and values above +4 illustrate the presence of an extreme excess of water resource.

Thus, from the analysis of the scenarios presented above, it appears that the risk of aridisation will increase over the next 40 years, especially during the summer months, as suggested by the simulations of the Palmer drought severity indices (Figure 4.5.2.2). The intensity of the aridisation depends on the scenario used, being higher for the worst case scenario RCP 8.5.

4.5.3 Predicted risks of extreme precipitations

In the context of an increased risk of aridisation, the frequency of precipitation will be lower, while the degree of torrentiality will be higher.

The measurements performed in the 3 monitoring stations in the area of the CTRF site, showed a maximum for 24 hours, of 155.5 mm at Cernavodă station, 84.6 mm at Medgidia station and 118.4 mm at Fetești station (Table 4.5.3.1).

The absolute maximum value of precipitation for 24 hours is 224 mm and was recorded in Drobeta Turnu-Severin on July 12, 1999. This absolute maximum value for the territory of Romania is much lower than the estimated values of maximum probable precipitation illustrated in the volume dedicated to EEON hydrological events [25].

Table 4.5.3.1 The maximum amount of precipitation in 24 hours with different probabilities, respectively, return periods, in the Cernavodă area (with historical data covering the period 1945-2017)

Probabilities (%)	20	10	5	2	1	0,5
Return periods (years)	5	10	20	50	100	200
Maximum amount of precipitation (in mm)	67,82	82,46	99,35	126,66	152,21	183,1

For the calculation of the probabilities and return periods of the precipitation amount in 24 hours, the maximum value observed in a year of the precipitation amount in 24 hours was calculated by ANM, for the area that includes the nuclear power plant, as the maximum value between the values recorded at 3 stations in the area analyzed, the covered period being 1945-2017 [25].

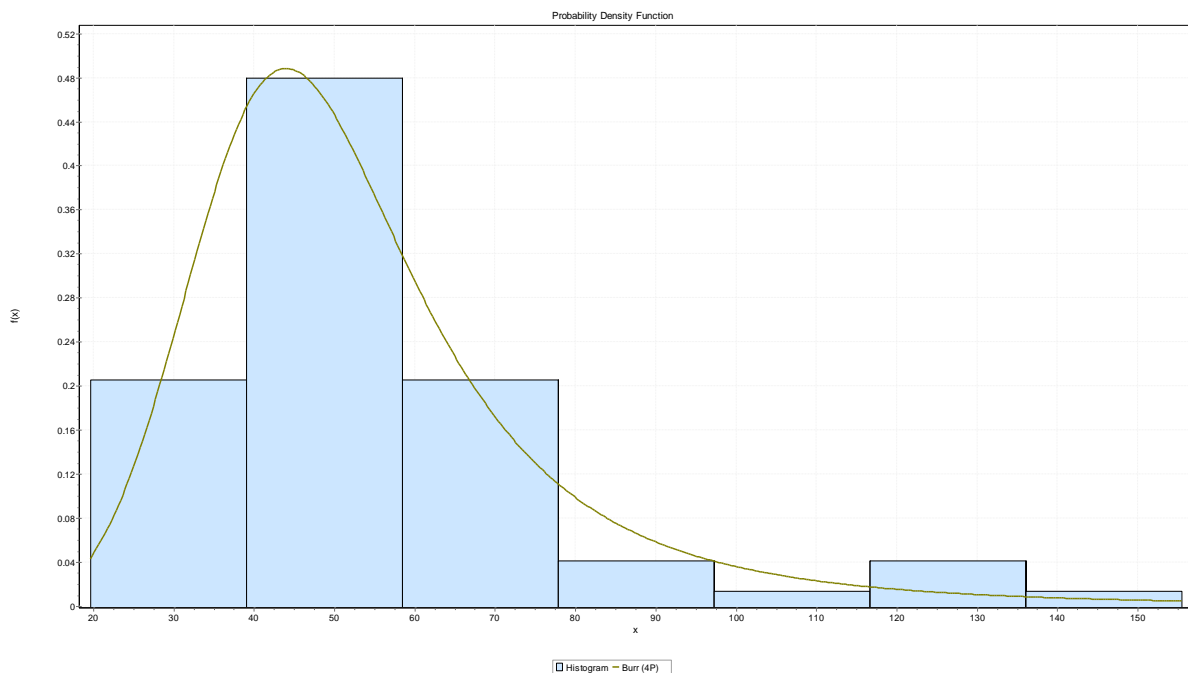

Figure 4.5.3.1 Probability density calculated using the Burr distribution (4P) for the histogram of absolute maximum amounts of precipitation falling in 24 hours in the area of the 3 analyzed stations (1962-2017)

The parameters of the theoretical distribution used are $k=0,87665$, $\alpha=4,1093$, $\beta=40,426$, $\gamma=7,2393$ [25]

Given that the composite range of values of the maximum amount of precipitation in 24 hours for the area including Cernavodă covers a period of more than 50 years, the uncertainties associated with the estimation of probabilities and return periods related to the length of the time series are

practically negligible for probabilities less than or equal to 0.5 and return periods less than or equal to 50 years.

Similar to the heat wave forecast analysis, to determine the risks of producing extreme amounts of precipitation, ANM (*National Meteorological Administration, T.N.*) used 24-hour maximum precipitation data, recorded in the Cernavodă area, and modeled using the RCP 4.5 climate scenario covering a moderate increase in temperatures for the period 2018-2057 (see Table 4.5.3.2).

Table 4.5.3.2 Maximum annual amount of precipitation in 24 hours (in mm) with different probabilities, respectively, return periods, in the Cernavodă area (with data from the simulations in the conditions of the scenario of moderate increase of the concentration of greenhouse gases - RCP 4.5, covering the period of 40 years 2018-2057) [25]

Probabilities (%)	20	10	5	2	1	0,5
Return periods (years)	5	10	20	50	100	200
CLM	52.42	62.92	75.03	94.38	112.17	133.27
HIRHAM5	76.78	109.13	149.0	215.2	277.09	350.64
RACMO	48.10	55.90	62.65	70.39	75.52	80.15
REMO	53.06	61.31	70.55	86.14	101.72	121.75
WRF	52.66	62.95	74.82	93.78	111.23	131.96
RCA4-ICHEC	45.73	53.82	61.78	72.41	80.68	89.21
RCA4-IPSL	51.09	61.34	71.98	87.05	99.40	112.72
RCA4-MPI	54.31	65.57	76.55	90.78	101.42	111.96

A worst case scenario was also considered by ANM (**National Meteorological Administration, T.N.*) (RCP 8.5 climate scenario), which includes a scenario with a significant increase in greenhouse gases (see Table 4.5.3.3).

Table 4.5.3.3 The maximum annual amount of precipitation in 24 hours (in mm) with different probabilities, respectively, return periods, in the Cernavodă area (with data from the simulations in the conditions of the worst case scenario of increasing the concentration of greenhouse gases - RCP 8.5, covering the period of 40 years 2018 -2057) [25]

Probabilities (%)	20	10	5	2	1	0,5
Return periods (years)	5	10	20	50	100	200
CLM	44.17	53.48	62.78	75.08	84.38	93.69
HIRHAM5	59.91	72.64	87.49	111.53	133.93	160.78
RACMO	43.79	49.33	54.12	59.73	63.60	67.24
REMO	51.22	64.45	79.22	101.39	120.42	141.64
WRF	45.83	55.59	68.26	91.00	114.26	144.46
RCA4-ICHEC	54.39	68.63	83.24	N/A	118.64	134.55

RCA4-IPSL	53.44	68.85	87.70	119.88	151.47	191.2
RCA4-MPI	58.95	73.73	91.79	123.0	154.2	194.16

The analysis of the 2 scenarios, highlights significant differences between the precipitation quantities simulated in forecast models. Therefore, the analysis of the most unfavorable scenario was chosen, namely the worst case scenario RCP 4.5, which estimates amounts of up to 350.64 mm of precipitation in the case of 0.5% assurance.

In such a precipitation scenario, there is a risk that the stormwater intake system will be outdated in terms of capacity and that excess water will cause site disturbances.

4.5.4 Predicted risks for floods caused by rivers

In the area of interest, the floods may come from watercourses represented by the Danube River (Dunărea Veche Arm / Caragheorghe), the Danube-Black Sea Canal, the Seimeni Canal, Valea Viteilor, and Valea Cismelei.

Along the time, a number of floods have occurred, such as the floods of 1970, 1980, 1981, and 2006; the water level reaching above the limits of the danger quotas for floods that have had some consequences in the area. The maximum flow rates recorded at their peak were: Q 1970 = 6230 m³ / s; Q1980 = 6400 m³ / s; Q1981 = 6550 m³ / s, Q2006 = 7000 m³ / s.

The possible evolution of the maximum water flows in the area must take into account at least two factors, namely: climate change (ie the possibility of increasing the number and so, the amount of precipitation) and on the other hand, the anthropogenic interventions, (or more precisely changes in water flows due to possible changes in the flow regime in the area of the Bala arm), these will lead to a possible increase in flows on the Dunărea Veche arm with negative effects on the high water regime.

Regarding the Danube River, a possible event that would cause the displacement of a significant volume and flow of water capable of producing a major flood on the Danube, would be a potential rupture of the Porțile de Fier I and Porțile de Fier II Dams. However, due to the distance of more than 600 km from the site to the above-mentioned dams, it would cause the flood wave to be attenuated, so that the effects on the site would not exceed the effects due to the high waters of the Danube [15].

In conclusion, there is no risk of flooding given the topography of the site and the physical impossibility of accumulating the water volume required for flooding.

4.5.5 Predicted risks of strong storms and winds

For the calculation of the probabilities and periods of return of the maximum wind speed, the maximum value observed in a year of this parameter was calculated by ANM, for the area that includes the nuclear power plant, as the maximum value between the 4 grid points analyzed [25].

Tables 4.5.5.1 and 4.5.5.2 show these probabilities and return periods for the simulated historical period (1971-2010) and for the next 40 years (2018-2057), by ANM under the conditions of the 2 climate scenarios (RCP4.5 and RCP 8.5).

(*ANM-National Meteorological Administration, T.N)

Table 4.5.5.1 The maximum annual value of the maximum wind (in m / s) with different probabilities, respectively return periods, in the Cernavodă area (with data from the simulations in the conditions of the scenario of moderate increase of the greenhouse gas concentration - RCP 4.5, covering the period of 40 years 2018 -2057) [25]

Probabilities (%)	20	10	5	2	1	0,5
Return periods (years)	5	10	20	50	100	200

CLM	15.85	16.2	16.50	17.01	17.55	18.30
HIRHAM5	N/A	N/A	N/A	N/A	N/A	N/A
RACMO	17.26	18.89	20.22	21.58	22.39	23.03
REMO	15.11	15.83	16.37	16.88	17.16	17.36
WRF	17.40	18.15	18.88	19.85	20.61	21.39
RCA4-ICHEC	13.91	14.60	15.21	15.90	16.37	16.80
RCA4-IPSL	15.44	16.08	16.75	17.72	18.51	19.37
RCA4-MPI	14.46	15.11	15.62	16.11	16.38	16.59

Table 4.5.5.2 The maximum annual value of the maximum wind (in m / s) with different probabilities, respectively return periods, in the Cernavodă area (with data from the simulations in the conditions of the worst case scenario of increasing the concentration of greenhouse gases - RCP 8.5, covering the period of 40 years 2018 -2057) [25]

Probabilities (%)	20	10	5	2	1	0,5
Return periods (years)	5	10	20	50	100	200
CLM	15.61	16.12	16.47	16.81	17.02	17.19
HIRHAM5	16.20	17.10	18.15	19.90	21.56	23.60
RACMO	15.66	17.08	18.37	19.86	20.83	21.66
REMO	14.64	15.67	16.85	18.78	20.60	22.82
WRF	17.40	18.15	18.88	19.85	20.61	21.39
RCA4-ICHEC	13.70	14.22	14.72	15.35	15.82	16.86
RCA4-IPSL	16.16	16.94	17.49	17.97	18.21	18.38
RCA4-MPI	14.08	14.60	15.03	15.51	15.82	16.11

The values of the maximum wind speed in the case of the most unfavorable scenario, will reach values of up to 23.60 m / s.

The results regarding the maximum annual value of the maximum wind (in m / s) with different probabilities, in the case of the 2 scenarios, are completed with the graphical analysis regarding the average change in the monthly average value of the maximum wind speed (see Figures 4.5.5.1 and 4.5.5.2) .

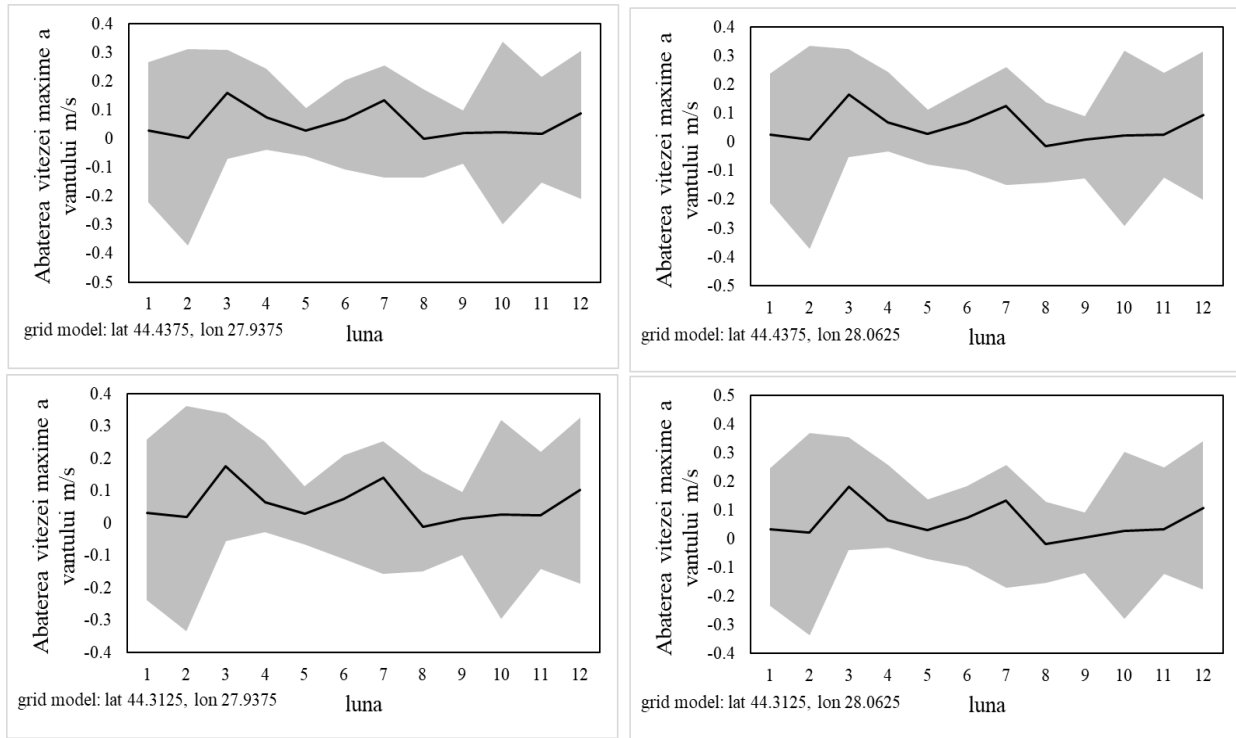

Figure 4.5.5.1 The average change in the average monthly value of the maximum wind speed, in the period 2018-2057 compared to 1971-2010, under the conditions of the RCP 4.5 scenario

In the period 2006-2010, included in the reference period 1971-2010, results were used under the conditions of the RCP 4.5 scenario, the gray band is the range of values of the set of regional models used by ANM, and the black line is the average value of this set [25].

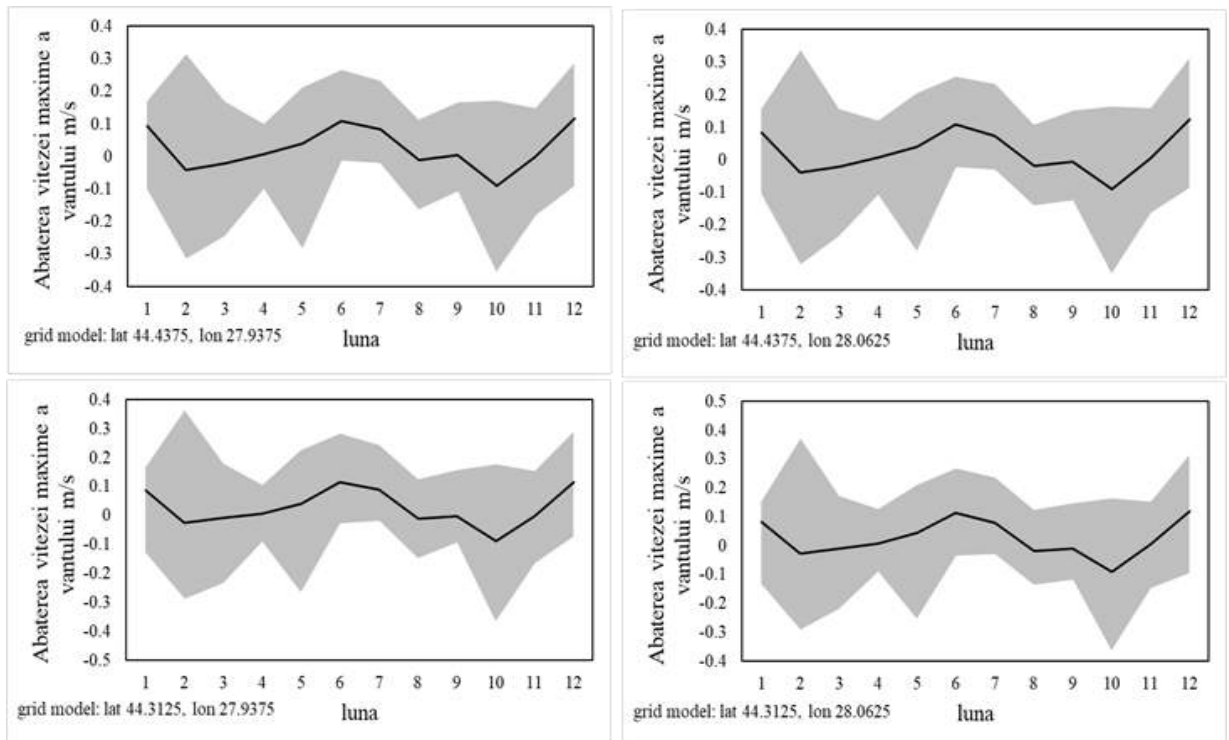

Figure 4.5.5.2 The average change in the average monthly value of the maximum wind speed, in the period 2018-2057 compared to 1971-2010, under the conditions of the RCP 8.5 scenario.

In the period 2006-2010, included in the reference period 1971-2010, results were used under the conditions of the RCP 4.5 scenario. The gray band is the range of values of the set of regional models used by ANM, and the black line is the average value of this set [25].

The signal change in the average maximum wind speed regime was determined by ANM to be insignificant [25]. Therefore, it can be concluded that the predicted risk for storms and high winds is similar to the current risk.

However, during periods of high winds, projectiles that could cause damage to the CTRF infrastructure and associated buildings could be carried by the wind.

4.5.6 Predicted risks for landslides

For the NPP site area, ground instability values are kept low even for the extreme situation. In the case of the area in question, ANM has estimated an increase in dry periods [25], which will further reduce the occurrence of landslides or crumbling [25].

4.5.7 Forecasted risks for rising sea levels, storm surges

Based on the models developed in the study "Key messages from the IPCC AR6 climate science report", the authors of the study concluded that sea levels are likely to rise globally by 4 to 9 mm/year, in the case of the RCP 2.6 scenario and by a rate of 10 - 20 mm / year in the case of the most worst case scenario RCP 8.5 [91].

Taking into account the most worst case scenario in the next 40 years, the maximum sea level will increase by 80 cm compared to the current one. Thus, the location of the CTRF installation will not be affected due to the height of the relief, which rises to over 10 m from the Black Sea, but also due to the height of the gates of the locks with heights over 10 m above the level of the Black Sea.

The two factors mentioned above would also prevent the advance of a water wave due to storm surges. Thus, in the event of a storm surge, the energy of the wave that will enter upstream on the Danube-Black Sea Canal will be dissipated so that the production of a flood caused by such a phenomenon in the area of the site is unlikely.

4.5.8 Predicted risks for cold periods

To estimate the risks predicted for cold periods, ANM used the historical data measured in the area of the CTRF site, during 41 years of monitoring (Table 4.5.8.1) [25].

Table 4.5.8.1 Minimum annual temperature (in °C) with different probabilities, respectively return periods, in the Cernavodă area (with data from historical simulations, covering the period 1970-2010) [25]

Probabilities (%)	20	10	5	2	1	0,5
Return periods (years)	5	10	20	50	100	200
CLM	-15.49	-17.15	-18.52	-20.06	-21.09	-22.03
HIRHAM5	-16.05	-18.76	-20.51	-21.71	-22.14	-22.36
RACMO	-20.14	-21.28	-22.15	-23.06	-23.63	-24.10
REMO	-19.31	-24.04	-26.76	-28.51	-29.11	-29.42
WRF	-21.39	-25.79	-28.76	-30.85	-31.61	-31.99
RCA4-ICHEC	-16.49	-20.97	-25.65	-29.85	-31.56	-32.48
RCA4-IPSL	-13.56	-16.37	-18.98	-22.25	-24.61	-26.89
RCA4-MPI	-13.93	-15.96	-17.73	-19.76	-21.12	-22.35

The analysis of historical data carried out by ANM shows that the minimum value recorded in the probability of 0.5% is -32.48 ° C.

The estimation of the cold periods was made using the 2 scenarios, respectively *RCP 4.5* and *RCP 8.5* (Tables 4.5.8.2 - 4.5.8.3).

Table 4.5.8.2 Minimum annual temperature (in ° C) with different probabilities, respectively return periods, in the Cernavodă area (with data from the simulations in the conditions of the moderate increase of the greenhouse gas concentration - *RCP 4.5*, covering the period of 40 years 2018 - 2057) [25]

Probabilities (%)	20	10	5	2	1	0,5
Return periods (years)	5	10	20	50	100	200
CLM	-12,86	-15,00	-17,10	-19,86	-21,95	-24,03
HIRHAM5	-12,78	-15,25	-17,76	-19,96	-20,85	-21,33
REMO	-11,84	-16,68	-21,31	-25,27	-26,84	-27,68
WRF	-17,44	-20,05	-22,46	-25,52	-27,79	-30,04
RCA4-ICHEC	-14,62	-17,38	-19,27	-20,89	-21,68	-22,22
RCA4-IPSL	-10,95	-14,06	-15,84	-17,01	-17,44	-17,68
RCA4-MPI	-12,85	-15,10	-16,50	-17,60	-18,10	-18,44

Table 4.5.8.3 Minimum annual temperature (in ° C) with different probabilities, respectively return periods, in the Cernavodă area (with data from the simulations in the conditions of the worst case scenario of increasing the concentration of greenhouse gases - *RCP 8.5*, covering the period of 40 years 2018 -2057) [25]

Probabilities (%)	20	10	5	2	1	0,5
Return periods (years)	5	10	20	50	100	200
CLM	-13,85	-16,18	-17,88	-19,13	-19,58	-19,82
HIRHAM5	-13,33	-15,97	-18,45	-20,57	-21,42	-21,87
RACMO	-19,81	-21,21	-22,11	-22,88	-23,26	-23,55
REMO	-13,76	-18,03	-22,15	-25,78	-27,26	-28,05
RCA4-ICHEC	-13,19	-16,81	-18,76	-19,96	-20,39	-20,62
RCA4-IPSL	-11,07	-15,92	-19,28	-21,68	-22,54	-22,99
RCA4-MPI	-13,62	-16,71	-18,73	-20,15	-20,67	-20,93

Compared to the results obtained after the 2 simulations, the average increase of the monthly average value for the minimum daily temperature, in the period 2018-2057 compared to 1971-2010, is between 1°C and 2°C, thus reducing the risk of frosty periods. The level of uncertainty is higher in the months of the cold season, but also in the months of August of the analyzed interval.

4.5.9 Damage caused by freeze-thaw phenomenon

The freeze-thaw phenomenon can affect the proper operation of CTRF equipment and systems exposed to the exterior. Direct consequences can be on the ventilation systems that can be blocked by ice layers deposited on the ventilation and air grilles.

The supply process may also be disrupted by freezing temperatures..

4.6 Population

4.6.1 Administrative and geographical location

The CTRF project is located in the western extremity of Constanța County, on its border with Ialomița and Călărași counties, in the administrative territory of Cernavodă City.

The city of Cernavodă covers an area of 46.69 km² [92], with a population of 18,602 inhabitants in 2020.

The city of Cernavodă, from the point of view of the administrative territory, borders the following ATUs:

- To the north with Seimeni Commune;
- To the east with the Communes of Saligny and Mircea Vodă;
- To the west with Borcea and Stelnică Communes; and
- To the south with Rasova and Peștera Communes.

It is located at the junction of the Danube-Black Sea Canal with the Danube River, about 145 km east of Bucharest. The access to the Cernavodă administrative-territorial unit area is made by rail via the railway line no. 8 Bucharest-Cernavodă and the secondary railway line Saligny - Cernavodă, which has as beneficiary the Cernavodă NPP [92]. From a road perspective, Cernavodă administrative-territorial unit is served by roads such as Autostrada Soarelui - A2 (Highway), National Road 22C and other county and communal roads.

4.6.2 Existing and future residential localities / areas and distances from location to residential or commercial areas

Cernavodă Administrative-Territorial Unit consists of only one locality represented by the city of Cernavodă, which is divided into 15 residential neighborhoods, located on the 2 banks of the Danube-Black Sea Canal, with different levels of comfort and technical and urban facilities (Table 4.6.2.1) [93].

Table 4.6.2.1 Residential areas in the administrative-territorial unit of Cernavodă City

Crt. no.	Neighborhood name	Location	Area / neighborhood type	Level of comfort and equipment	Distance to CTRF
1.	Prund	north	Mostly ground floor buildings	Very low	4,32 km
2.	Columbia	north	Mostly multistoried buildings	Medium	4,32 km
3.	Serelor	north	Subdivisions for buildings GF and GF + 1	In the process of equipping	
4.	Pompieri – Releu	north	Subdivisions for buildings GF + GF, GF + 1, GF + 1-2	In the process of equipping	
5.	Seimeni Nord	north east	Neighborhood GF and Gf + 1 buildings	In the process of equipping	3,5 km

6.	I.D. Chirescu	north east	Mostly multistoried buildings	Moderate	3,777 km
7.	Deal Sofia	northwest	Mostly buildings GF	Moderate	4,038 km
8.	Tudor Vladimirescu	east	Mostly multistoried buildings	Moderate	2,793 km
9.	Centru	center	Mostly GF buildings	Moderate	3,3 km
10.	Trust	south-southeast	Mostly multistoried buildings	Moderate	2,051 km
11.	Energiei	south east	Mostly multistoried buildings	moderately high	2.071 km
12.	Campusuri	south	Mostly Gf + 1 buildings	High	1,88 km
13.	Cartier nou CNE	south	-	-	-
14.	Cochirleni	south	Mostly GF buildings	In the process of equipping	3,049 km
15.	Dealul Vifor	south	Mostly GF buildings	In the process of equipping	3,4 km

Note: Distances from CTRF project location to residential areas were calculated in Google Earth.

There are notable discrepancies between the 15 residential neighborhoods of Cernavodă in terms of living standards and conditions, which lead to distortions of behavior and identification within the community. Therefore, it is necessary to continue building new homes, removing used collective buildings, possibly demolishing some, in this way reducing concentrations of the population can be achieved. It is also necessary to complete the new neighborhoods with essential public facilities [93].

The development potential of residential areas is limited by the characteristics of the relief and the soil. Thus, it is envisaged to build a new residential area in the northern part of Cernavodă, an area that will include a housing complex situated on about 7 hectares, at the exit to Seimeni. The complex will have 21 blocks with a ground floor and a first floor, in each of which there will be 10-12 apartments. These will include a total of 252 homes, representing studios and apartments with 2 or 3 rooms. The distance from this new residential complex to the CTRF site is estimated at 4.5 km to the north.

There is also a project regarding the Civic Center of Cernavodă, where the construction of an area of 8 dwellings with GF + 1 height regime is considered, a height that does not visually obscure the overall view of the Danube [93].

4.6.3 Occupations and activities of the inhabitants of the area

Regarding the occupations and activities of the inhabitants of the area, information was taken from "*Strategia de dezvoltare integrată a oraşului Cernavodă pentru perioada 2015-2020*". (Integrated Development Strategy of the city of Cernavodă for the period 2015-2020). Thus, at the level of 2011, out of the total of 18,532 inhabitants, 6,865 represent the active persons and the distribution by types of economic activities carried out by them indicates the employment structure, analyzed according to the total share.(Table 4.6.3.1).

Table 4.6.3.1 Distribution of the population by economic activities in the city of Cernavodă in 2011

Economic activity	Absolute number	Share in total employed population (%)
Construction	1234	17,97
Production and supply of electricity and heat, gas, hot water and air conditioning	1139	16,59

Manufacturing industry	991	14,43
Wholesale and retail trade; repair of motor vehicles and motorcycles	838	12,21
Administrative and support service activities	497	7,24
Public administration and defense; social security in the public system	426	6,21
Transport and storage	388	5,66
Other economic activities	1352	19,69
TOTAL	6865	100

According to the information presented in Table 4.6.3.1, the construction sector and the electricity generation and supply sector are the most important economic activities. The analysis of economic activity over time indicates that the two sectors of economic activity remain in the top of the rankings for over 25 years. Both sectors of economic activity are dependent on the activity of the main employer in the area of influence of Cernavodă NPP, and the activity of constructions and related services is closely related to the works being carried out at and for Cernavodă NPP [93].

4.7 Human health

In 2018, the National Institute of Public Health carried out the study "Studiul de evaluare a impactului radiologic asupra stării de sănătate a populației generat de operarea CNE- Cernavodă din arealul de 30 km in jurul obiectivului" ("Assessment of the radiological impact on the health status of the population generated by the operation of the Cernavodă NPP in the area of 30 km around the facility") [96].

The study was prepared in accordance with the provisions stipulated by the Order of the Minister of Health no.119/2014 and in accordance with the fundamental principles of public health regarding the protection of the population's health, in compliance with the provisions based on the technical documentation submitted by the beneficiary [96].

The conclusions of the study are as follows [96]:

- **Overall, the normal operation of the Cernavodă NPP is within the dose constraints set for the source term as estimated in the technical documentation.**
- **The estimated radiological impact on the health of the population in the 30 km area, generated by the operation of the Cernavodă NPP under normal conditions, ranges into the very low risk category: between 1 in 100 000 and 1 in 10 000 lifetime cancer risk.**

Also, specifically for the CTRF project, the National Institute of Public Health carried out in 2015 the study „Studiul de evaluare a impactului radiologic asupra sanatatii populatiei in zona de influenta CNE Cernavodă in relatie cu functionarea normala a Instalatiei de detritiere CNE Cernavodă /Cernavodă Tritium Removal Facility (CTRF)" ("Assessment study of the radiological impact on the health of the population in the area of influence of the Cernavodă NPP in relation to the normal operation of the Cernavodă NPP/Cernavodă Tritium Removal Facility (CTRF)") [94].

The conclusions of the study are as follows [94]:

- **Overall, the Cernavodă NPP, normal operation of the Tritium Removal Facility brings, according to the estimates of the technical documentation, a reduction of potential damage associated with tritium emissions in environmental factors and, consequently, a benefit to the health of the population living in the area of influence of the Cernavodă NPP.**
- **Provided that the models and conclusions of the technical documentation are correct and complete, and that compliance with the technical measures for the**

operation of the facility is ensured, the impact on the health of the population associated with the operation of the facility can be assessed as insignificant.

4.7.1 Population exposure to CTRF activity

Unlike other industrial activities, the impact on the population, resulting from nuclear activities carried out on the Cernavodă NPP platform, also includes a component arising from exposure to ionizing radiation as a result of the release of radioactive effluents into the environment.

In order to limit this impact, CNCAN imposed, in the authorization process, a series of constraints associated with major sources of radioactive emissions. These constraints are expressed in terms of effective dose for a representative person in the population and are called dose constraints. Their values are 100 microSv / year for the exposure from the radioactive emissions of each Unit.

As the CTRF facility will manage a significant inventory of radioactive material, CNCAN will establish a dose constraint to authorize its operation so that the risk to the population is kept to a minimum as long as the facility is properly operated. The value of this dose constraint will be 10 microSv / year [2].

For the Cernavodă NPP units, the dose constraints are transposed into derived limits of discharge into the environment, based on a calculation model, approved by CNCAN, which takes into account the emission pathways, dispersion environments and radionuclide propagation pathways from source to human receptor. The calculation model is a segmental model in which the transfer between two compartments is done by means of transfer coefficients (linear transfer). Thus, in the case of gaseous emissions, the exposure routes considered by the calculation model are the following:

- Atmosphere - Soil with vegetation - Equivalent dose (external exposure)
- Atmosphere - Agricultural crops - Committed dose (ingestion)
- Atmosphere - Soil with vegetation - Crops - Committed dose (ingestion)
- Atmosphere - Soil with vegetation - Fodder - Animal product - Committed dose (ingestion)
- Atmosphere - Feed - Animal product - Committed dose (ingestion)
- Atmosphere - Animal product - Committed dose (ingested)
- Atmosphere - Surface water - Fish (lake) - Committed dose (ingestion)
- Atmosphere - Committed dose (inhalation)
- Atmosphere - Equivalent dose (external exposure by immersion)

Similarly, the following exposure routes have been considered for liquid emissions:

- Water - Soil with vegetation - Equivalent dose (external exposure)
- Water - Soil with vegetation - Agricultural crops - Dose employed (ingestion)
- Water - Feed - Animal product - Committed dose (ingested)
- Water - Soil with Vegetation - Forage - Animal Product - Committed Dose (Ingestion)
- Water - Agricultural crops - Committed dose (ingestion)
- Water - Animal Product - Committed Dose (Ingestion)
- Water - Fish - Committed dose (ingestion)
- Water - Committed dose (ingestion)
- Water - Equivalent dose (external exposure by immersion)

As the emission of liquid effluents can be achieved in two ways (in the Danube, through Seimeni discharge canal, or in the Danube-Black Sea Canal, when repairs to the Seimeni Canal are needed), and the use of water in the area influenced by Cernavodă NPP is different for different population groups, we opted for the differentiated calculation of the derived limits for three categories of representative persons (residents of Cernavodă, Seimeni and Constanța). A conservative choice of the most restrictive limit associated with the corresponding emission was made, as presented in the 2 studies dedicated to assessing the radiological impact on the health

of the population generated by the operation of Cernavodă NPP in the area of 30 km around the NPP, as well as the radiological impact in relation to the normal functioning of CTRF.

In the period 2020 - 2021 ICSI Rm. Vâlcea and RATEN ICN Pitești took samples for airborne radioactivity analysis, drinking water, surface water, food chain samples. Results of the analysis and dose calculations were validated by Ion CHIOSILĂ PhD - CNCAN Level III expert in Radiological Protection.

Dose constraints (0.1 mSv per unit) were fractionated in relation to the emission pathways of radioactive effluents and radionuclides likely to be present in these effluents (Table 4.7.1.1).

Table 4.7.1.1 Fractionation of dose constraints with respect to radioactive effluent emission pathways and radionuclides likely to be present in effluents

The evacuation way	Weight on the evacuation way	Radionuclides	Share on radionuclides	Dose constraint (mSv)
Gaseous emissions	75%	H-3	70%	0.0525
		C-14	20%	0.0150
		Noble gases * and short-lived and very short-lived isotopes of iodine **	9%	0.45×10^{-3} (for each radionuclide)
		I-131, radioactive particles ***	1%	28×10^{-6} (for each radionuclide)
Liquid emissions	25%	H-3	97%	0.02425
		C-14, I-131, short-lived and very short-lived isotopes of iodine ** and Radioactive particles ***	3%	22.7×10^{-6} (for each radionuclide)

*⁴¹Ar, ⁸⁵Kr, ^{85m}Kr, ⁸⁷Kr, ⁸⁸Kr, ^{131m}Xe, ¹³³Xe, ^{133m}Xe, ¹³⁵Xe, ^{135m}Xe, ¹³⁸Xe,

**¹³²I, ¹³³I, ¹³⁴I, ¹³⁵I

***⁵¹Cr, ⁵⁴Mn, ⁵⁹Fe, ⁵⁸Co, ⁶⁰Co, ⁶⁵Zn, ⁸⁹Sr, ⁹⁰Sr, ⁹⁵Zr, ⁹⁵Nb, ⁹⁹Mo, ¹⁰³Ru, ¹⁰⁶Ru, ^{110m}Ag, ¹²²Sb, ¹²⁴Sb, ¹²⁵Sb, ¹³²Te, ¹³⁴Cs, ¹³⁷Cs, ¹⁴⁰Ba, ¹⁴¹Ce, ¹⁴⁴Ce, ¹⁵²Eu, ¹⁵⁴Eu, ¹⁵³Gd, ¹⁸¹Hf

Applying the model described above, derived evacuation limits have been established which are maximum activities, cumulated annually, for each of the radionuclides considered and for each of their emission pathways. Table 4.7.1.2 shows the values of the derived tritium evacuation limits, the radionuclide of interest for CTRF. These limits apply to the management of effluent discharges from each of the Cernavodă NPP units.

Table 4.7.1.2 Derived evacuation values for tritium

Release path in the environment	Derived limit (TBq / year)	The representative person	
		Location	Conservative hypotheses
Gaseous evacuations	3960	Cernavodă, 2 km from NPP	Child (0-1 years) - average food consumption It is assumed that fruits, vegetables and most animal products come from local sources
Liquid evacuations into the Danube	49200	Seimenii Mari	Child (0-1 years) - average food consumption
Liquid evacuations into the Danube - Black Sea canal	1970	Cernavodă	Child (0-1 years) - average food consumption

In conjunction with the management of radioactive emissions, Cernavodă NPP monitors the radioactivity present in the environmental factors in order to radiologically characterize, annually, the elements of the environmental factors considered in establishing the derived evacuation limits. The results of the effluent control and environmental radioactivity monitoring programs are used to assess doses to the population by one of two methods, as follows: the method based on the results of effluent monitoring and the method based on the results of environmental radioactivity monitoring, as presented in reference [84].

The method based on the results of the monitoring of effluent emissions starts from the values of the conversion factors f_i , determined by the model of calculation of the derived limits (named in the report IR 96002 027, developed by SNN CNE [31], Maximum annual effective doses for an emission rate of 1 Bq / s) which are multiply by a (virtual) emission rate calculated as the annual emission relative to the monitoring interval.

Dose conversion factors for exposure routes originating in the gaseous emissions are given in Table 4.7.1.3.

Table 4.7.1.3 Dose conversion factors for gaseous exposure routes

	f_i (Sv / year per Bq / s)		
	Inhalation	ingestion	Total
adult (H-3)	1.96E-13	1.47E-13	3.44E-13
child (H-3)	2.50E-13	1.68E-13	4.18E-13

Similarly, Table 4.7.1.4 shows the conversion factors established for exposure assessment in the case of exposure routes originating from liquid effluents.

Table 4.7.1.4 Dose conversion factors for liquid effluent exposure routes

	f_i (Sv / year per Bq / s)		
	Cernavodă	Constanta	Seimeni
H-3 adult	1.77E-13	2.35E-13	8.51E-15
H-3 child	3.83E-13	3.57E-13	1.53E-14

Applying this method, it concludes that by 2020, the effective (maximum) dose associated with tritium emissions in the form of gaseous effluents was 4.43 microSv, while the effective (maximum) dose associated with tritium emissions in the form of liquid effluents was of 0.09 microSv.

Another method of assessing exposure is based on the results of monitoring the radioactivity of the environment, using these values to calculate each of the components of the effective dose that constitutes the end of a route of exposure.

Applying this method, it can be calculated that the effective dose for the representative person in the population, as a result of exposure to radioactivity present in the environment, due to tritium emissions in the form of liquid and gaseous effluents, was in 2020 of 0.306 microSv.

Regarding the CTRF operation, the projected emissions of tritium will be a total of a maximum of 50 TBq / year, under the conditions of heavy water processing from the Moderator System. The average release rate, under these conditions, will be 1.59 MBq / s. If the entire tritium activity is released in the form of gaseous effluents, then the maximum effective dose of the representative person in the population will be 0.7 microSv / year, and in case the tritium will be released in the form of liquid effluents, the maximum effective dose of the representative person in the population will be 0.6 microSv / year. This calculation is ultra-conservative, as it was not taken into account that in the case of CTRF, gaseous emissions have an important component of tritium gas, for which the dose coefficients (from CNCAN order no. 145/2018, taken from ICRP 116) are five orders smaller than those recommended for the evaluation of the effective dose by inhalation of tritiated water vapor

In order to calculate the cases of fatal cancer, in excess, the risk coefficients presented in Table 4.7.1.5 are indicated in the scientific literature.

Table 4.7.1.5 Risk coefficients for calculation of fatal cancer cases, in excess

Category	Risk coefficient (1 / Sv)	
	ICRP	BEIR VII
Adults	4.1×10^{-2}	3.8×10^{-2}
General population	5.5×10^{-2}	4.7×10^{-2}

Based on conservative dose estimates, using the highest value of risk factors, it can be estimated that annual tritium emissions from CTRF may be associated with an additional 3.7×10^{-8} risk of cancer induction.

Assuming the continuous exposure of the reference person to the same level of emissions for 70 years (hypothetical situation, practically impossible due to the much shorter planned duration of operation of the CTRF installation), the risk will be 2.55×10^{-6} .

However, the population health impact assessment as a result of the CTRF operation must be made in terms of its protection following the reduction of the emission levels of Cernavodă NPP, along with reducing the tritium inventory in moderator and primary heat transfer systems from the two reactors.

The operating experience of Unit 1 (Figure 4.7.1.1) has shown that, since commissioning, annual liquid effluent emissions have increased from 0.78 TBq / year in 1996 to 134 TBq / year in 2020, with a maximum value of 1970 TBq / year in 2012. The total emission of tritium in 2020 in the form of liquid effluents of Cernavodă NPP was of 240 TBq, a value obtained by cumulating the emissions from the two operating CANDU units of the plant. This trend of increasing tritium emissions in effluents is due to the increase in its concentration in the moderator and primary heat transfer systems, maintenance works, etc.

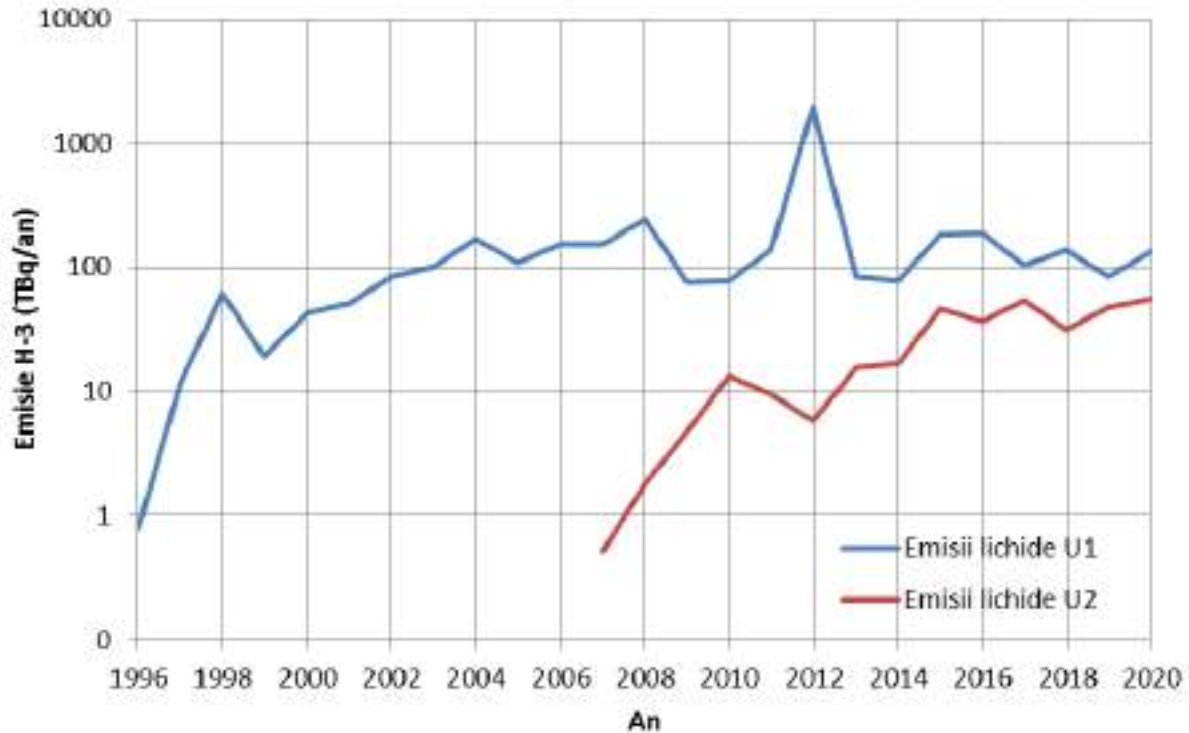

Figure 4.7.1.1 Annual emissions of tritium in the form of liquid effluents from Cernavodă NPP

**(Emisie H-3 – H-3 Emission, Emisii lichide – Liquid emissions, An - Year)*

Tritium gaseous emissions followed a trend similar to that of liquid emissions (Figure 4.7.1.2), starting from a value of 1.4 TBq in 1996 (due to U1, the only one in operation at the time) and reaching a cumulative annual emission of the two units, of 337 TBq in 2020, of which the emission due to unit 1 was 183 TBq.

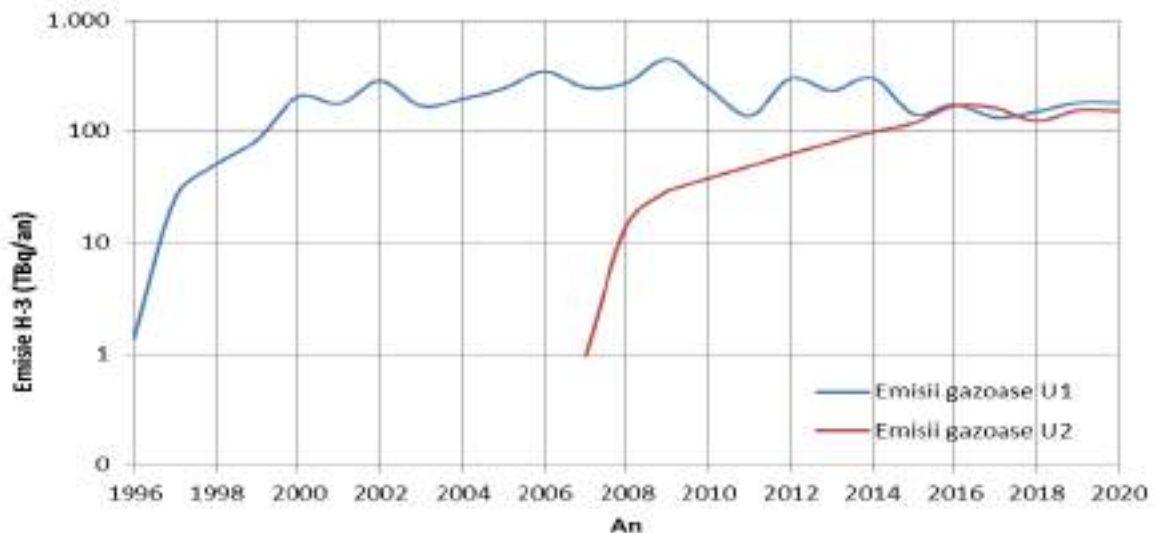

Figure 4.7.1.2 Annual tritium emissions in the form of gaseous effluents from Cernavodă NPP

**(Emisie H-3 – H-3 Emission, Emisii lichide – Liquid emissions, An - Year)*

4.7.2 Presentation and validation of up-to-date data used for public dose assessment

The radiological monitoring performed within the environmental monitoring program at Cernavodă NPP includes determinations of radioactivity on samples of plants and animal products that are included in the diet of the population in the area of influence of the NPP.

For this purpose, samples are taken weekly - milk samples, biannually - fish and meat samples and annually - samples of: vegetables, fruits, eggs and cereals. All of these samples are analyzed to determine the activity concentration of beta-emitting radionuclides, gamma-emitting radionuclides, and tritium and C-14.

Fish samples are taken from three locations inside farms (All-01 Tibrinu, SSS-14 Baciú and SSS-15 Făclia) and from two locations for monitoring wildlife (LII-05 Deversare CDMN, LII-09 Capidava). In 2020, the global beta activity concentration in fish samples was in the range of 28 - 63 Bq / kg, the tritium activity concentration was distributed in the range of 4 - 14 Bq / kg, and the activity concentration of C-14 was in the range 271 - 312 Bq / kg C.

Results similar to those obtained in the Environmental Radioactivity Monitoring Programme are recorded in the analysis carried out by ICSI RM. Vâlcea on a fish sample taken in September 2020 from the Danube River, downstream of the confluence with the cooling water discharge channel (according to Table 4.7.2.1). The higher value of the beta-global activity concentration is due to the reporting to the dry mass of the sample, as opposed to NPP that reports the activity to the wet sample mass.

Table 4.7.2.1 Results of radioactivity tests in fish samples - 2020

Determined parameter / Capidava fish	Result	Measurement report/ issuer
H-3 activity concentration (Bq / kg fw)	2.2 ± 0.4	146 / 05.11.2020 ICSI RM. Valcea
OBT activity concentration (Bq / l water comb.)	4.7 ± 0.4	
C-14 activity concentration (Bq / g C)	0.238 ± 0.016	
Global beta activity concentration (Bq / kg dw)	186.07 ± 36.48	
Gamma emitting radionuclide activity concentration (Bq / kg)	SLD *	

*SLD- below the detection limit. The limit of detection was calculated for a number of Cernavodă NPP specific gamma-emitting radionuclides and is specified in the analysis reports

Analysis regarding the contamination with actinides of the fish resource in the area of influence of Cernavodă NPP showed that this category of radionuclides is below the detection level of the methods used (Table 4.7.2.2).

Table 4.7.2.2 Results of radioactivity tests in fish samples

Measured parameter / Danube fish	Result	Measurement report/ issuer
Pu-239/240 activity concentration (mBq / g)	<0.3	827 / 19.10.2021 RATEN ICN
Pu-238 activity concentration (mBq / g)	<0.3	
Am-241 activity concentration (mBq / g)	<0.2	
U-238 activity concentration (mBq / g)	2.4 ± 1.7	
U-235 activity concentration (mBq / g)	<0.3	
U-234 activity concentration (mBq / g)	<0.3	

The milk, collected from the location All-02 - Seimeni cow farm, in 2020, did not show contamination with gamma-emitting radionuclides, and the activity concentration of tritium was in the range of values 2 - 46 Bq / l, the average value being 9.4 Bq / l, and the maximum value being registered during April. The concentration of global beta activity in milk samples had average monthly values in the range 33 - 58 Bq / l, with an average of 46 Bq / l, and the activity concentration of C-14 was distributed in the range 262 - 387 Bq / kg C, with an average of 316 Bq / kg C.

Similar results were recorded by ICSI Rm. Vâlcea, by analyzing a milk sample taken in September 2020 from Seimeni (according to Table 4.7.2.3). The higher value of the beta-global

activity concentration is due to the reporting to the dry mass of the sample, as opposed to the NPP that reports the activity to the wet sample mass.

Table 4.7.2.3 Results of radioactivity tests in milk samples - 2020

Determined parameter / Seimeni milk	Result	Measurement report/ issuer
H-3 activity concentration (Bq / kg fw)	8.4 ± 0.7	145 / 05.11.2020 ICSI RM. Valcea
OBT activity concentration (Bq / l water comb.)	6.5 ± 0.5	
C-14 activity concentration (Bq / g C)	0.226 ± 0.016	
Global beta activity concentration (Bq / kg dw)	1074.66 ± 200.87	
Gamma emitting radionuclide activity concentration (Bq / kg)	SLD *	

*SLD- below the detection limit. The limit of detection was calculated for a number of Cernavodă NPP specific gamma-emitting radionuclides and is specified in the analysis reports

During 2020, 10 samples of chicken, pork and beef were taken from monitoring locations located in Cernavodă and Seimeni. Average of values of activity concentrations determined for the radionuclides identified in these samples are given in Table 4.7.2.4.

Table 4.7.2.4 Results of radioactivity tests in meat samples-2020

Sample type	Global Beta (Bq / kg)	K-40 (Bq / kg)	H-3 (Bq / kg)	C-14 (Bq / kg C)
Chicken meat	77	126	3	307
Pork	179	124	2	326
Beef	75	135	2	264

In parallel, in September 2020 ICSI Rm. Vâlcea took a sample of chicken from the Seimeni location, and the results of the determinations performed on it are presented in table 4.7.2.5.

Table 4.7.2.5 Results of radioactivity tests in meat samples - 2020

Determined parameter / Seimeni meat	Result	Measurement report/ issuer
H-3 activity concentration (Bq / kg fw)	3.4 ± 0.4	144 / 05.11.2020 ICSI RM. Valcea
OBT activity concentration (Bq / l water comb.)	6.1 ± 0.5	
C-14 activity concentration (Bq / g C)	0.227 ± 0.016	
Global beta activity concentration (Bq / kg dw)	175.16 ± 33.90	
Gamma emitting radionuclide activity concentration (Bq / kg)	SLD *	

*SLD- below the detection limit. The limit of detection was calculated for a number of Cernavodă NPP specific gamma-emitting radionuclides and is specified in the analysis reports

As can be seen, the results of the independent analyses fit within the variation range of the determinations made during the monitoring programme.

In 2020, samples of eggs taken from two locations were analyzed: AII-03 Cernavodă - Agri-food market and LII-08 Seimeni - private households. In these samples, the average global beta activity concentration was 28 Bq / kg, the average tritium activity concentration was 12 Bq / kg, and the average C-14 activity concentration was 336 Bq / kg C. Analysis by gamma spectrometry did not highlight anthropogenic radionuclides.

In 2020, plant-based foods were radiologically monitored by sampling fruits, vegetables and cereals, as follows:

- 16 fruit samples (representative of the diet and agricultural specifics of the area: cherries, strawberries, apricots, peaches and grapes) from 4 harvest points: Satu Nou - Orchard farm, Cernavodă - Agri-food market, Seimeni - private households and Cernavodă - Grape farm;
- 39 samples of vegetables specific to the local diet and produced in the area of influence of the Cernavodă NPP, from the same locations as the fruit samples;
- 6 samples of cereals: 2 samples of wheat and 4 samples of corn.

The average values of the determined activity concentrations for the radionuclides in the samples are given in Table 4.7.2.6.

Table 4.7.2.6 Results of radioactivity analysis of food samples of plant origin

Sample type	Global Beta (Bq / kg)	K-40 (Bq / kg)	H-3 (Bq / kg)	C-14 (Bq / kg C)
Fruits	41	61	32	325
Vegetables	53	79	5	254
Cereals	79	107	1	303

During the year 2020 ICSI Rm. Vâlcea, took a sample of fruits and two samples of vegetables on which it made determinations of radioactive content. The results of these analysis are presented in Table 4.7.2.7.

Table 4.7.2.7 Results of radioactivity analysis of food samples of plant origin

Determined parameter	Apples sample	Pepper sample	Celery sample
H-3 activity concentration (Bq / kg fw)	19.6 ± 1.2	2.3 ± 0.5	10.4 ± 0.8
OBT activity concentration (Bq / l water comb.)	20.2 ± 1.3	5.9 ± 0.5	3.8 ± 0.4
C-14 activity concentration (Bq / g C)	0.227 ± 0.016	0.217 ± 0.016	0.220 ± 0.016
Global beta activity concentration (Bq / kg dw)	208.39 ± 39.83	884.01 ± 165.33	1038.59 ± 194.15
Gamma emitting radionuclide activity concentration (Bq / kg)	SLD *	SLD *	SLD *

Sampling location	Seimeni	Siliștea	Siliștea
Measurement report	149 / 05.11.2020	147 / 05.11.2020	150 / 05.11.2020

*SLD- below the detection limit. The limit of detection was calculated for a number of Cernavodă NPP specific gamma-emitting radionuclides and is specified in the analysis reports

The radiological characterization of the vegetal food products was completed by RATEN ICN Pitești by taking a sample of leafy vegetables on which determinations were made to establish the content of alpha emitting radionuclides (actinides). The results of these determinations are presented in Table 4.7.2.8.

Table 4.7.2.8 Results of radioactivity analysis of food samples of plant origin

Measured parameter / leafy vegetables	Result	Measurement report/ issuer
Pu-239/240 activity concentration (mBq / g)	<0.3	826 / 19.10.2021 RATEN ICN Pitesti
Pu-238 activity concentration (mBq / g)	<0.3	
Am-241 activity concentration (mBq / g)	<0.3	
U-238 activity concentration (mBq / g)	<0.3	
U-235 activity concentration (mBq / g)	<0.3	
U-234 activity concentration (mBq / g)	1.0 ± 0.6	

4.7.3 Validation of the results of analysis and public dose calculations

The validation was carried out, in accordance with legal requirements, by Dr. Eng. Alexandru TOMA and Dr. Eng. Cristian Nicolae DULAMA, experts in radiological protection, authorised by CNCAN and co-authors of this report. **The purpose of the validation was to confirm the aspects, results and considerations related to the calculation of radiation doses for the population in the Cernavodă NPP area based on analysis of radioactivity in air, drinking water, surface water, and food chain samples.**

Assessments were based on **tritium activity values, C-14 and other radionuclides** existing / determined in the area of 30 km around NPP - Cernavodă, in normal operating conditions and in accident conditions based on current studies and information. Based on these radioactivity values, the effective dose was calculated / estimated for the representative person in the population.

It also analysed: the situation of environmental contamination with tritium, C-14 and other radionuclides, as well as the actual doses received by the population in the Cernavodă NPP area based on a complex program to monitor environmental radioactivity, necessary to assess the radiological impact on the population and the environment due to the operation of the two units with CANDU reactors. Results obtained by LCM Cernavodă within this radioactivity monitoring program was completed, in the last year, with radioactivity analysis performed within ICSI Rm. Vâlcea and RATEN ICN Pitești.

The stations and time intervals for sampling were chosen so as to maximize the probability of highlighting the presence of polluting radionuclides from Cernavodă NPP in the environmental factors.

Environmental factors analyzed:

- air samples inside and outside the Cernavodă NPP (30 km area around the plant), aerosols (material particles in the air) and humid atmospheric deposits;
- water samples: from the overflow canal, domestic wastewater from the plant platform, groundwater, drinking water from the Cernavodă city network;
- soil samples inside and outside the NPP area, in order to estimate the transfer of radionuclides into the spontaneous and cultivated vegetation;
- samples of fruits (apples), vegetables (peppers, celery), cereals; and
- samples of animal products (milk, chicken / pork / beef, fish).

Radioactivity analysis:

- within the Environmental Radioactivity Monitoring Program at Cernavodă NPP: global beta activity, K-40, H-3, C-14;
- analysis performed on environmental samples at ICSI Rm. Vâlcea: H-3, OBT, C-14, global beta activity, gamma emitting radionuclides; and
- analysis performed at RATEN ICN Pitesti: Pu-239/240, Pu-238, Am-241, U-238, U-235, U-234.

Results

The current situation and the evolution of radioactivity parameters in the environmental and food samples were analysed, especially H-3, in order to estimate / calculate the effective dose received by the population living in the area of the plant, especially the city of Cernavodă.

The results of the H-3, C-4 and global beta activities performed on some environmental and food samples by ICSI Rm. Vâlcea were at values almost identical to those obtained by LCM Cernavodă.

The results of the actinide determinations performed by RATEN ICN Pitești showed values below the detection limit of the equipment used, for all radioisotopes analyzed, (except uranium isotopes, naturally present in the environment) which indicates that it is not possible to discuss contamination of environmental factors by Cernavodă operations for this category of radionuclides.

Estimation of the exposure dose of tritium for the population of the Cernavodă NPP area

Dose constraints for a representative of the population with values below 100 μSv / year, imposed by CNCAN, are transposed into limits derived from the discharge of radioactive effluents into the environment; a calculation model is used that takes into account the emission pathways, dispersion environment and radionuclide propagation pathways from source to population. The transfer coefficients for gaseous and liquid effluents are then calculated and the effective dose is calculated using the dose / conversion factors.

For 2020, the maximum effective dose, calculated on the basis of H-3 activity from gaseous radioactive effluents released by the plant, was 4.43 μSv / year and the effective dose, due to H-3 from liquid effluents, was 0,09 μSv / an.

The effective dose, based on tritium concentrations, determined in 2020, for each of the environmental factors that make up the exposure of the representative person in the population, was 0.306 μSv / year.

The calculations show that in the most unfavorable conditions, after one year of operation of the CTRF, the effective dose to the representative person in the population will decrease by more than 14%.

By implementing the heavy water tritium removal facility at Cernavodă NPP, the tritium inventory in the active systems of the plant will be gradually reduced, which will lead to a significant reduction in the levels of tritium in the radioactive effluents.

The value of the dose constraint associated with the operation of CTRF, established by CNCAN in the authorization procedure of Cernavodă NPP, is 10 μSv / year.

Conclusions

By choosing the samples, stations and sampling intervals, as well as the radioactivity analysis that are the basis for estimating the effective dose for the population, a complex program has been / is being carried out to monitor possible radioactive pollutants discharged into gaseous and liquid effluents from CANDU reactors of Cernavodă NPP.

Results of radioactivity measurements from environmental and food samples, in particular those of tritium eliminated in the environment, together with an estimate of the effective dose for the population can be considered a good database needed for comparison with the results obtained after the implementation of the CTRF project.

The implementation of the CTRF project at Cernavodă NPP will lead to a significant decrease in the tritium discharges of Cernavodă NPP correlated with a corresponding decrease in exposure to ionising radiation of the population in the area of influence of the plant.

4.8 Radioactivity

According to the CTRF feasibility study [2], the facility was designed to treat the heavy water in the moderator and primary heat transfer systems of the two operating CANDU units of the Cernavodă NPP in such a way as to ensure that an activity concentration below 10 Ci/kg is maintained for tritium in the moderator circuits. In order to illustrate the evolution of tritium activity concentrations in the moderator circuits of the two units, a simulation is made in the above-mentioned document in which alternative operation of the CTRF is considered for two years for each of the two units, followed by alternative operation for one year, depending on the planned shutdown periods. The results of this simulation are shown in Figure 4.8.1.

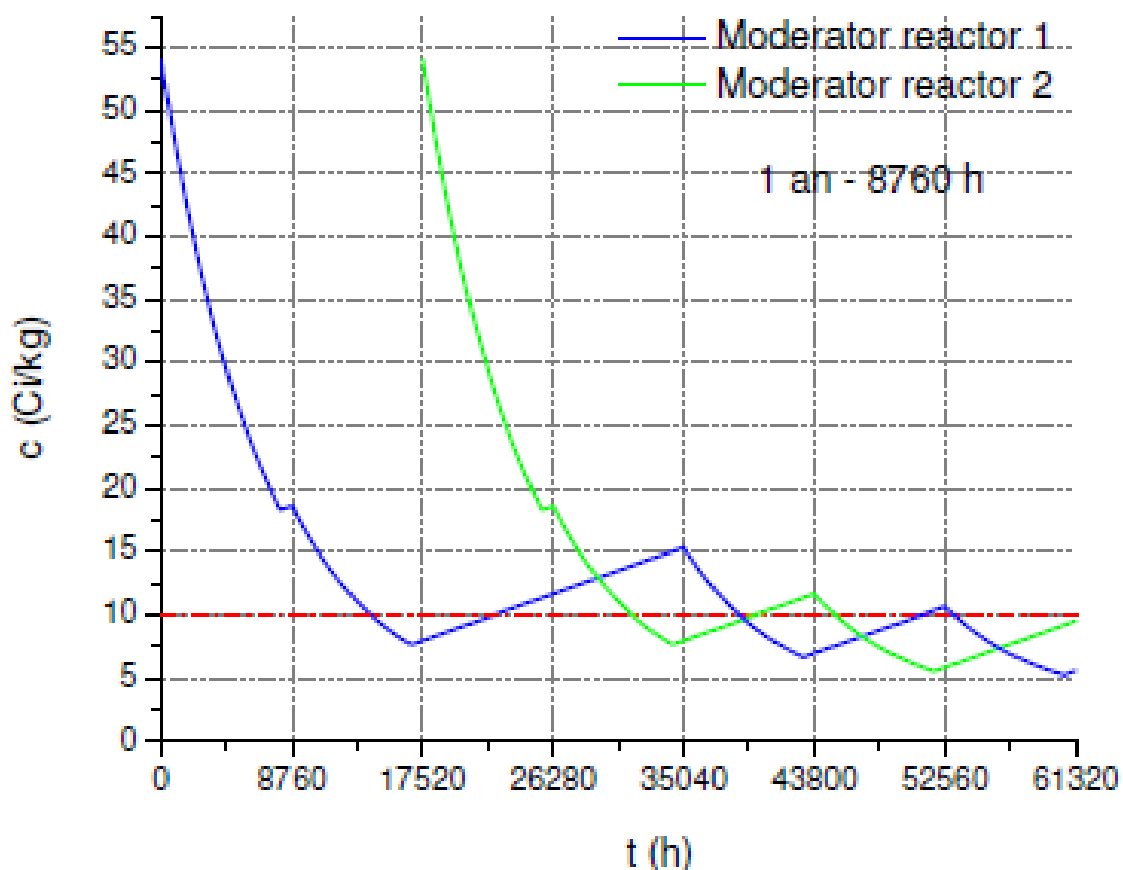

Figure 4.8.1 CTRF operating chart for reactors 1 and 2 with proposed operating target of 10 Ci/kg [2].

As can be seen the simulation was carried out starting from the operational limit of 54 Ci/kg for the tritium concentration in the fed heavy water, and the time interval in which the process

ensures the reduction by half of the tritium concentration in the moderator system of a unit is about 5300 h.

For the typical CANDU-6 reactor, the steady state tritium level is reached after 2/3 of the reactor life cycle. By operating the CTRF the tritium concentration will be reduced from 80-90 Ci/kg to about 10 Ci/kg for the Moderator System and from about 2-2.5 Ci/kg below this value for the Primary Heat Transport System [1]. Under these conditions, it is noted that for Unit 1 the tritium activity concentration in the moderator circuit has now exceeded the operating limit of the CTRF, and the plant should initially be fed with a reduction of this concentration by dilution with virgin heavy water. Thus, assuming a concentration of 85 Ci/kg in the moderator circuit of U1, a dilution of about 1.6 times will be required for the first transfer to the CTRF, and this dilution will gradually decrease until the feed can be made without dilution. Thus, it is estimated that in the first year of operation of the CTRF (8000 hours), the tritium activity concentration in the moderator circuit of U1 will decrease from 85 Ci/kg to about 38 Ci/kg, with an average concentration over the year of 61 Ci/kg. As tritium emissions to the environment originate from heavy water losses in the plant circuits (5% heavy water from the moderator circuit and 95% heavy water from the primary heat transport circuit) it implies that at the current concentration of tritium activity in the two circuits of U1, heavy water losses from the moderator circuit contribute more than 60% of the tritium activity emitted to the environment. Thus, assuming that the steady-state atmospheric emissions from U1 before the commissioning of the CTRF are about 200 TBq/year (which translates to an effective dose to a representative person in the population of 2.65 microSv/year), during the first year of operation they will decrease to 166 TBq (which translates to an effective dose of 2.2 microSv), representing a decrease of about 17%.

The calculation model based on the use of radioactive emission values and the application of transfer factors specific to radionuclide migration pathways (compartmental model), presented in subchapter 4.7.1, was used for the above estimates.

4.9 Material goods

The CTRF installation will be located in an industrial area, in the inner perimeter of the Cernavodă NPP. The Cernavodă NPP site partially or completely covers a former limestone quarry, operational from 1900-1979. Thus, any archaeological remains from the quarry's footprint have already been removed during its exploitation. The land in the Project area was subsequently consolidated during the construction of the Cernavodă NPP, the Project area therefore has a very low potential for possible buried and unregistered heritage remains.

Also, in the perimeter of the project there are no buried heritage assets to be included on the List of historical monuments or in the national archaeological repertoire, the Cernavodă NPP area is not registered as having heritage, architectural and/or landscape value.

In the vicinity of the project, the nearest registered site with archaeological values represented by the settlement area and the ritual area Cernavodă (RAN. No. 60785.26), at approx. 2 km west of the project as evidenced by the extensive list of historical monuments in the area of Cernavodă, which includes archaeological monuments, architectural monuments, public monuments and memorial and funerary monuments. The list classifies the monuments as category A- of national interest, and category B- of local interest. In the city of Cernavodă there are 16 historical monuments, of which 5 are category B, as shown in Table 3.9.1.3, in Chapter 3.

There are no cultural heritage assets of national importance listed in the National Archaeological Repertory (RAN) of the Romanian National Heritage Institute within the vicinity of the CTRF project.

The potential impact identified for the construction and operation phases of the CTRF on the material assets recorded in the vicinity of the site is presented in Chapter 5.

If, during the construction or maintenance work of the CTRF, an accidental archaeological discovery is made, the NPP must stop the works, notify the competent authorities and place a cordon around the discovered area. The NPP will not disturb any discovery until a heritage specialist has been contacted who can identify the discovery, record and identify its significance.

4.10 Conclusions of the Security Analysis and Reports

The Security Report (SEVESO, rev.1 of 2021) includes the analysis of the hazards, natural and technological risks that may arise in the CTRF project, addressing issues related to the probability of occurrence and consequences of project-related technological accidents

The use of hydrogen, oxygen and diesel fuel are the main risk factors identified in the Seveso report. The results of the analysis show that the identified risks are reduced to a low/moderate level by safety measures, prevention, and implementation of the environmental and risk management system foreseen in the project.

Based on the results presented in the SEVESO Report, the vulnerability of the project to a possible disaster is given by an extreme earthquake (above the design seismic base level) with a return period exceeding 1E-5/year. In such a scenario, the connecting pipe between the liquid phase catalytic isotope exchange system and the first cryogenic distillation column may rupture, resulting in hydrogen (deuterium) leaking from the pipe for up to 10 minutes, with the containment system going into operation. The consequences of this disaster are reduced by existing prevention measures such as seismic qualification and automatic isolation chambers, which limit the release of hydrogen into the building, thus reducing the inventory that could participate in an explosion. The effects can be mainly material, limited to the facility.

Project vulnerability to accidents may be caused by a cylinder explosion at the CTRF oxygen and helium cylinders storage, which could have major consequences in the immediate vicinity of the explosion source and a possible domino effect on other cylinders in the storage, due to overpressure, or of generated projectiles. According to the risk analysis, the possible causes for such a scenario could be defective construction materials or external fires at other installations. The probability of the scenario is low due to the existing safety measures taken for storage and handling of cylinders.

The report "CTRF Accident Analysis Report for Public Dose, KI CTRF-00437 Rev 05" [95] analyzes the events with implications on the radiological safety of the CTRF installation. The events considered in this analysis are accompanied by uncontrolled emissions of tritium from the installation, and the doses received by the population as a result of these emissions are assessed. The highest value of the effective dose to a person in the population as a result of the events analysed is less than half of the dose limit for population exposure as a result of authorised practices (normal activities), indicating that the radiological impact on the population due to an event at the CTRF is insignificant.

5. DESCRIPTION OF THE SIGNIFICANT EFFECTS THAT THE PROJECT MAY HAVE ON THE ENVIRONMENT

This chapter describes and analyzes the potential impacts on environmental factors and the human population, generated by the implementation of the CTRF project. The cumulative impact is also analyzed, assessing the possible cumulative effects of the project with other projects planned to be built / put into operation in parallel with the CTRF, as well as the potential to produce a cross-border impact that may result from project construction and operation. The method and criteria for impact assessment used by the developer are in accordance with Order 269/2020.

The decommissioning of the CTRF facility will be carried out on the basis of a specific decommissioning project, as presented in subchapter 1.4.4. Thus, the environmental impact assessment at the decommissioning stage of the facility is not addressed in this chapter.

The impact assessment method and criteria used by the developer are in accordance with Order 269/2020 on the approval of the general guide applicable to the stages of the environmental impact assessment procedure, the guide for environmental impact assessment in a transboundary context and other specific guides for different areas and categories of projects.

The environmental impact assessment of the implementation of the CTRF project took into account the technology and substances used, as presented in subchapter 1.3 of this report.

5.1 Potential impact from the use of natural resources in the context of sustainable development

The construction of the CTRF facility will be based on the principles of sustainable development, aiming at minimizing the use of natural resources, by judicious planning/optimizing the quantities of raw materials to be used in the realization of the project, so as to avoid unnecessary stocks. The natural resources used are: river stone/broken stone, sand, soil (the land on which the building is to be built), water.

Resources from protected natural areas will not be used in the construction of the CTRF project.

The CTRF plant will be built on land within an industrial platform, used exclusively for the construction of the Nuclear Power Plant. The area of land to be used for construction is not within a protected natural area, is not registered as an archaeological site and has no use with direct economic value for the population (agriculture, livestock, etc.).

In the operational phase, the entire site will be occupied by the footprint of the CTRF building and adjacent concrete platforms.

The access to the Tritium Removal Plant will be done by using the existing access ways on the Cernavodă NPP platform.

Thus, the implementation of the CTRF project will result in the loss of vegetation cover on an area of approx. 1,350 m² and the unavailability of the land for at least 40 years.

The management of materials in the natural resource category will be done as judiciously and efficiently as possible so that the CTRF project can be considered to be carried out in the spirit of sustainable development. Thus, neither the construction nor the operation of the CTRF facility will have a significant impact in terms of the use of materials from the category of exhaustible natural resources.

5.2 Assessment of potential impacts on environmental factors

5.2.1 Environmental factor water

Construction stage

The most common sources of pollution of the environmental factor water during the construction phase of the project are accidental pollution with hydrocarbons and other chemicals (paints, solvents) from machinery/equipment used/other activities on site, accidental spills of contaminated water from site organisation, with the potential for infiltration into the groundwater.

Other potential sources of contamination are domestic sewage from the contractor's staff, improper temporary storage of waste, which can be a source of accidental pollution if washed away by rainwater, and the washing of equipment and wheels of transport vehicles in unsuitable areas.

The water requirement for construction activities will not have any significant effect on the availability of water supply in the Cernavodă NPP area, as it will be supplied from the Cernavodă NPP water supply network, with no direct abstraction from natural emissaries. Also, water consumption for the constructor's staff will be ensured through bottled water supply.

The works in the construction phase will be carried out in compliance with the Cernavodă NPP procedures, the measures proposed in chapter 7 of this report, and all the approvals/authorisations to be obtained for the project. The drainage of rainwater from the site organization area will be carried out by portable drainage pumps located in the low points of the excavation and connected with flexible hoses to the rainwater drainage network of the Cernavodă NPP platform in the immediate vicinity.

The Danube River, the Danube-Black Sea Canal and the Cernavodă Lock Canal are the closest natural receptors to the Cernavodă NPP site and have a high sensitivity to possible negative impacts due to accidental overflows and discharges during the construction phase of the project.

Taking into account the aspects presented above and considering the fact that the construction/assembly works related to the CTRF plant will be of a seasonal nature, the small number of workers actually on site that will generate domestic wastewater, the distance from the CTRF site to the nearest receptors, as well as the implementation of protection and mitigation measures and good construction practices, it is estimated that the impact generated during the construction phase on the water environmental factor is negligible, indirect, reversible, local and short-term.

Operating stage

The sources and management of radiologically uncontaminated wastewater have been presented in Chapter 1 of this report.

The radiological impact on the water environmental factor may be due to liquid effluent emissions under normal or accident conditions. Releases from the project during normal operation may be due to leakage from process systems within the facility or during planned operations (e.g. equipment maintenance). Releases of tritiated heavy water (DTO) may be caused by leaks at pipe and equipment joints and as a result of maintenance operations such as replacing a filter, valve or repairing a pump.

As explained in section 4.1, tritium releases in the form of liquid effluents from units 1 and 2 of the Cernavodă NPP do not significantly affect the quality of surface waters in the area of influence of the plant. Also, the results of the radioactivity monitoring of drinking water and deep groundwater in the area of the Cernavodă NPP site show that they are free of radioactive contamination, which means that the impact of tritium releases from the NPP on these waters is neutral. Liquid effluents from the CTRF will be managed under the same management system as those from the operation of the plant's two CANDU units. The quantity of liquid effluents produced in CTRF and discharged in the active drainage system of Unit 1 is much lower than the amount of liquid effluents produced in normal operation by Unit 1 and consequently the radiological impact is less. The application of the measures foreseen in the effluent management programme of the NPP will allow the emissions to be kept under control, within the derived discharge limits, so that the radiological impact on the water environmental factor is kept as low as reasonably achievable. In view of these considerations the radiological impact on the water environmental factor associated with tritium emissions from the CTRF will be minor, directly cumulative, reversible, local and short term.

Through the application of tritium removal process, it is expected that the tritium emissions in the liquid effluents from the Cernavodă NPP site will be gradually reduced, which will lead to a corresponding reduction of the radiological impact of the plant's activities on the water environment. Thus, the radiological impact on the water environmental factor due to the operation of the CTRF, as an ALARA (As Low As Reasonable Achievable) measure to reduce tritium releases in the form of liquid effluents from Units 1 and 2, can be considered to be positive, direct, reversible, local and long-term.

In the operational phase the input of domestic wastewater from the CTRF plant to be discharged into the existing domestic sewage network is very low considering the number of staff that will operate the plant. Thus, the average input of 2.90 m³/day (as per subchapter 1.4.6.2) of domestic wastewater to be added to the domestic wastewater generated by the staff servicing the existing activities in U1 will not exceed the wastewater carrying capacity of the existing networks. In view of these considerations, the impact will be negligible, indirect, reversible, local and short-term.

5.2.2 Environmental factor air

Construction stage

Potential sources of pollution during the construction phase of the CTRF plant are dust, NO₂, SO₂ and CO emissions. These emissions are generated by construction activities such as excavation for access roads, foundations, backfilling, levelling, compaction, earthworks, and transport and temporary storage of excavated soil. Dust emissions can also be generated from the supply and temporary storage of construction materials, the construction of foundations and

superstructure - concrete pouring, drilling, sanding, pipe and duct cutting and temporary storage and loading of construction waste, wind erosion from disturbed ground surfaces and from soil stockpiles temporarily stored for backfilling, and re-suspension of particles by entrainment from surfaces due to vehicle movement.

In order to describe the effects that the CTRF project may have on the environmental factor air, a series of maps on the spatial distribution of non-radiological pollutant concentrations for the construction phase were produced (Annex 12).

For the elaboration of these maps, the input data included meteorological parameters that were taken from the *Meteorological Study on the Cernavodă NPP site, 2019 [21]* and the *emissions of pollutants resulting from the combustion of fuels in the engines of construction equipment and machinery that were calculated on the basis of the provisions of Order 3299/2012 [10]* - mobile sources represented by the operation of motorized mobile machinery and equipment, code NFR 1.A.2. .f.ii - Non-road mobile sources and equipment (in the industrial sector) and mobile sources represented by vehicle traffic on the installation site, NFR code 1.A.3.b.ii and NFR code 1.A.3.b.iii.

Meteorological parameters and types/quantities of gaseous emissions generated by the project during the construction phase are presented in Tables 1.4.9.1.1 and 1.4.13.1.

From the analysis of the maps, it can be seen that the activities during the construction phase will show variations in the concentrations of the emitted gases.

Thus, for nitrogen oxides, the modelled concentrations outside the site are characterised by values in the range $6.25 \mu\text{g}/\text{m}^3$ - $12.50 \mu\text{g}/\text{m}^3$ and for carbon monoxide in the range $3 \mu\text{g}/\text{m}^3$ - $6 \mu\text{g}/\text{m}^3$ in the immediate vicinity of the site and $1 \mu\text{g}/\text{m}^3$ - $3 \mu\text{g}/\text{m}^3$ at distances of 1 km around the site.

Particulate matter - $\text{PM}_{2.5}$ and PM_{10} fractions, will show values in the range of 0.4 - $0.5 \mu\text{g}/\text{m}^3$ outside the Cernavodă NPP site.

The values of the off-site concentrations are below the legal limit values for the protection of human health, established by Law no.104/2011, for the protection of human health and the environment as a whole by regulating measures to maintain ambient air quality. Thus, by implementing the protection and mitigation measures described in Chapter 7, the NPP procedures and good construction practices, the impact generated during the construction phase on the on-site and off-site air environmental factor is negligible, direct, reversible, local and short-term.

Direct greenhouse gas emissions

In the construction phase, total greenhouse gas emissions include emissions from the transport of materials and waste to and from the construction site, and emissions from the use of heavy machinery and equipment during construction.

The emissions of pollutants resulting from the combustion of fuels into the engines of construction equipment and machinery are presented in sub-chapter 1.4.9.1. Emissions from the use of heavy machinery and equipment during construction will be closely related to the performance of the equipment and machinery to be used by the organisation responsible for the site activities. Emissions of pollutants decrease the more advanced the performance of the engines, i.e. lower fuel consumption per unit of power and tighter emission control.

Operating stage

Through normal operation of the CTRF plant, acidifying pollutants, ozone and ozone precursors or particulate matter (SO_2 , NO_x , CO and PM_{10} , $\text{PM}_{2.5}$) are emitted into the atmosphere. To describe the effects that the CTRF project may have on the air environmental factor for short-term exposure (2 hours of operation per month), a series of maps on the spatial distribution of non-radiological pollutant concentrations for the operation stage were produced (Annex 13).

Analysis of the transposition of pollutant concentrations into spatial distribution maps for the operating stage (one stand-by Diesel - generator unit) revealed that in the immediate vicinity, outside the NPP site, nitrogen oxide values are in the range of 11.82 - 7.99 $\mu\text{g}/\text{m}^3$, and at distances of 5 km, they reach up to 0.35 $\mu\text{g}/\text{m}^3$.

In the case of sulphur oxides and carbon monoxide, the values are significantly lower, ranging from 1.25-0.85 $\mu\text{g}/\text{m}^3$ and 1.79-1.21 $\mu\text{g}/\text{m}^3$ respectively.

Particulate matter - PM_{10} fractions will show values between 0,54 - 0,36 $\mu\text{g}/\text{m}^3$ and $\text{PM}_{2,5}$ values between 0,45 - 0,3 $\mu\text{g}/\text{m}^3$.

The maximum values reached for the test scenarios of a Diesel-generator group are below the legal limit values established by Law no. 104/2011, which aims to protect human health and the environment as a whole by regulating the measures aimed at maintaining the ambient air quality.

Also, from the analysis of the maps made, it can be seen that in the case of the conservative approach with simultaneous operation of the two Stand-by Diesel generator groups, the emission concentrations are almost double. **However, this conservative approach used in the dispersion modelling highlights a maximum impact that will not be achieved in practice, considering the small number of emission sources that can operate and the fact that the two diesel back-up generator sets will not operate simultaneously; they have been designed as redundant.**

The values of off-site concentrations are below the legal limit values for the protection of human health, established by Law no.104/2011, except for NO_2 in the immediate vicinity of the Cernavodă NPP. Thus, the impact generated during the operational phase on the on-site and off-site air environmental factor is negligible, direct, reversible, local and short-term.

Direct greenhouse gas emissions

Through normal operation of the CTRF plant insignificant greenhouse gas emissions (CO_2 , CH_4 , HFCs, PFCs, N_2O , SF_6) will be generated.

During **operation stage**, direct greenhouse gas emissions may result from the interruption of the electricity supply when the Stand-by Diesel- generator units are in operation (or during their periodic testing - 2 hours/month/ Stand-by Diesel - generator unit).

The estimated direct emissions of greenhouse gases generated by the 2 Stand-by Diesel-generator units are of maximum 395.03 t CO_2 /year. Considering that the supporting activities, such as the operation for periodic testing of the Stand-by Diesel-generator sets and the on-site traffic characterized by discontinuous, short duration and low value emissions, it is estimated that the normal operation of the CTRF plant will have a negligible, direct, reversible, local and short-term impact on the air quality on the Cernavodă NPP platform.

Cumulative effect of non-radioactive emissions from the Cernavodă NPP and the CTRF project

On the Cernavodă NPP site, non-radiological atmospheric emissions are associated with the following activities [38]:

- Burning of light fuels (light fuel oil - LFO) for the boilers in the start-up thermal power plant;
- Diesel fuel combustion for Stand-by Diesel generator units;
- Diesel fuel combustion for Emergency Diesel generator units;
- Management activities (storage/handling) of liquid fuels;
- Activities for internal transport.

Thermal Power Plant (PTC)*

Thermal Power Plant Start-up operates only for short periods of time to support the shutdown of the two units and to start one of the units from cold. When one unit is running, the PTC is kept in

stand-by as the second source needed to shut down and keep the unit warm. No maintenance and repair work shall be performed on the PTC unless both units are in operation.

* (PTC) – CTP, Romanian language, T.N.

Stand-by power supply system (SDG)*

"The Standby power system comprises four Stand-by Diesel generator sets with a maximum output of 4400 kW/group at unit U1 and two Stand-by Diesel-generator sets of 7000 kW/group at unit U2. The Diesel sets are separated by fire-resistant walls. The Diesel generators operate only in situations of loss of Class IV power system (equivalent to loss of connection to the national power system) and each unit is tested monthly for two hours at both U1 and U2.

* **SDG**=Stand-by Diesel Generator, T.N.

Emergency Power System (EPS)

The emergency power supply system consists of two Emergency Diesel generators per unit (U1 and U2) with a rated output of 1000 kW/unit. The Diesel generators operate in emergency situations, but start up periodically and are tested at regular intervals (each Diesel generator starts up every two weeks for two hours) [38].

Emissions from these sources were calculated as part of the Environmental and Social Impact Assessment Study conducted by WSP UK Ltd in August 2021 [112] and are detailed in Table 5.2.2.1.

Table 5.2.2.1 Existing sources of non-radiological emissions and calculated emissions for the Cernavodă NPP site, detailed for each source

Source of emission	Height (m)	Diameter (m)	Gases temperature (°C)	Gas velocity (m/s)	NO _x kg/h	SO _x kg/h	CO kg/h	PM ₁₀ kg/h
CTP – stack 1	26	1.3	166	15	1,01	5	0,4	0,43
CTP – stack 2	26	1.3	166	15	1,01	5	0,4	0,43
SDG 1 – U1	19	0.8	410	12	6,8	0,00325	0,925	0,2175
SDG 2 – U1	19	0.8	410	12	6,8	0,00325	0,925	0,2175
SDG 3 – U1	19	0.8	410	12	6,8	0,00325	0,925	0,2175
SDG 4 – U1	19	0.8	410	12	6,8	0,00325	0,925	0,2175
SDG 1 – U2	22	0.91	365	15	28,9	0,015	3,99	0,92
SDG 2 – U2	22	0.91	365	15	28,9	0,015	3,99	0,92
EPS 1 – U1	10	0.3	370	8	3,95	0,002	0,545	0,125
EPS 2 – U1	10	0.3	370	8	3,95	0,002	0,545	0,125
EPS 1 – U2	10	0.3	370	7	4,2	0,00215	0,575	0,13735
EPS 2 – U2	10	0.3	370	7	4,2	0,00215	0,575	0,13735

Based on the data in Table 5.2.2.1, concentrations and dispersion factors for non-radiological air emissions were calculated for the Cernavodă NPP site. For this calculation, the positioning of emission sources on the site and meteorological parameters taken from the Meteorological Study on the Cernavodă NPP site, 2019 [21] and presented in subchapter 1.4.13 were used.

The calculated concentrations of the different pollutants at different distances are given in Table 5.2.2.2 and were used for the calculation of the dispersion coefficients in Table 5.2.2.3.

Table 5.2.2.2 Calculated concentrations at an average ambient temperature of 22°C, average wind speed of > 6 m/s, at 0 m above ground for existing non-radiological emission sources at the Cernavodă NPP site

Distance (Km) \ Emission gas concentrations (µg / m ³)	0.2	0.5	0.8	1	1.5	2	5	8	10	15	20	25	30
CTP – stack 1													
NO_x	7.07	1.92	0.86	0.59	0.3	0.19	0.05	0.03	0.02	0.01	0.01	0.01	0.01
SO_x	34.99	9.52	4.27	2.92	1.48	0.93	0.24	0.13	0.1	0.06	0.04	0.03	0.03
CO	2.8	0.76	0.34	0.23	0.12	0.07	0.02	0.01	0.01	0	0	0	0
PM₁₀	3.01	0.82	0.37	0.25	0.13	0.08	0.02	0.01	0.01	0.01	0	0	0
SDG 1-4 – U1													
NO_x	65.96	14.61	6.39	4.35	2.2	1.38	0.36	0.19	0.15	0.09	0.06	0.05	0.04
SO_x	0.03	0.01	0	0	0	0	0	0	0	0	0	0	0
CO	8.97	1.99	0.87	0.59	0.3	0.19	0.05	0.03	0.02	0.01	0.01	0.01	0.01
PM₁₀	2.11	0.47	0.2	0.14	0.07	0.04	0.01	0.01	0	0	0	0	0
SDG 1-2 - U2													
NO_x	245.41	58.86	26.01	17.71	8.97	5.64	1.46	0.79	0.6	0.37	0.27	0.21	0.17
SO_x	0.13	0.03	0.01	0.01	0	0	0	0	0	0	0	0	0
CO	33.88	8.13	3.59	2.45	1.24	0.78	0.2	0.11	0.08	0.05	0.04	0.03	0.02
PM₁₀	7.81	1.87	0.83	0.56	0.29	0.18	0.05	0.03	0.02	0.01	0.01	0.01	0.01
EPS 1-2 – U1													
NO_x	55.32	10.33	4.43	2.99	1.51	0.94	0.24	0.13	0.1	0.06	0.04	0.03	0.03
SO_x	0.03	0.01	0	0	0	0	0	0	0	0	0	0	0
CO	7.63	1.43	0.61	0.41	0.21	0.13	0.03	0.02	0.01	0.01	0.01	0	0
PM₁₀	1.75	0.33	0.14	0.09	0.05	0.03	0.01	0	0	0	0	0	0
EPS 1-2 – U2													
NO_x	59.11	11.04	4.73	3.2	1.61	1.01	0.26	0.14	0.11	0.07	0.05	0.04	0.03
SO_x	0.03	0.01	0	0	0	0	0	0	0	0	0	0	0
CO	8.05	1.5	0.64	0.44	0.22	0.14	0.04	0.02	0.01	0.01	0.01	0.01	0
PM₁₀	1.92	0.36	0.15	0.1	0.05	0.03	0.01	0	0	0	0	0	0

Table 5.2.2.3 Dispersion coefficients for non-radiological emission sources at the Cernavodă NPP site

Pollutant / Distance (Km)	0.2	0.5	0.8	1	1.5	2	5	8	10	15	20	25	30
CTP – stack 1													
NO _x (10 ⁻⁶ * s/m ³)	25.2	6.84	3.07	2.1	1.07	0.68	0.18	0.11	0.07	0.04	0.04	0.04	0.04
SO ₂ (10 ⁻⁶ * s/m ³)	25.19	6.85	3.07	2.1	1.07	0.67	0.17	0.09	0.07	0.04	0.03	0.02	0.02
CO (10 ⁻⁶ * s/m ³)	25.2	6.84	3.06	2.07	1.08	0.63	0.18	0.09	0.09	0	0	0	0
PM ₁₀ (10 ⁻⁶ * s/m ³)	25.2	6.87	3.1	2.09	1.09	0.67	0.17	0.08	0.08	0.08	0	0	0
SDG 1-4 – U1													
NO _x (10 ⁻⁶ * s/m ³)	34.92	7.74	3.38	2.3	1.17	0.73	0.19	0.1	0.08	0.05	0.03	0.03	0.02
SO ₂ (10 ⁻⁶ * s/m ³)	33.23	11.08	0	0	0	0	0	0	0	0	0	0	0
CO (10 ⁻⁶ * s/m ³)	34.91	7.75	3.39	2.3	1.17	0.74	0.2	0.12	0.08	0.04	0.04	0.04	0.04
PM ₁₀ (10 ⁻⁶ * s/m ³)	34.92	7.78	3.31	2.32	1.16	0.66	0.17	0.17	0	0	0	0	0
SDG 1-2 - U2													
NO _x (10 ⁻⁶ * s/m ³)	30.57	7.33	3.24	2.21	1.12	0.7	0.18	0.1	0.08	0.05	0.03	0.03	0.02
SO ₂ (10 ⁻⁶ * s/m ³)	31.2	7.2	2.4	2.4	0	0	0	0	0	0	0	0	0
CO (10 ⁻⁶ * s/m ³)	30.57	7.34	3.24	2.21	1.12	0.7	0.18	0.1	0.07	0.05	0.04	0.03	0.02
PM ₁₀ (10 ⁻⁶ * s/m ³)	30.56	7.32	3.25	2.19	1.14	0.7	0.2	0.12	0.08	0.04	0.04	0.04	0.04
EPS 1-2 – U1													
NO _x (10 ⁻⁶ * s/m ³)	50.42	9.42	4.04	2.73	1.38	0.86	0.22	0.12	0.09	0.06	0.04	0.03	0.03
SO ₂ (10 ⁻⁶ * s/m ³)	54	18	0	0	0	0	0	0	0	0	0	0	0
CO (10 ⁻⁶ * s/m ³)	50.4	9.45	4.03	2.71	1.39	0.86	0.2	0.13	0.07	0.07	0.07	0	0
PM ₁₀ (10 ⁻⁶ * s/m ³)	50.4	9.5	4.03	2.59	1.44	0.86	0.29	0	0	0	0	0	0
EPS 1-2 – U2													
NO _x (10 ⁻⁶ * s/m ³)	50.43	9.42	4.04	2.73	1.37	0.86	0.22	0.12	0.09	0.06	0.04	0.03	0.03
SO ₂ (10 ⁻⁶ * s/m ³)	50.23	16.74	0	0	0	0	0	0	0	0	0	0	0
CO (10 ⁻⁶ * s/m ³)	50.4	9.39	4.01	2.76	1.38	0.88	0.25	0.13	0.06	0.06	0.06	0.06	0
PM ₁₀ (10 ⁻⁶ * s/m ³)	50.32	9.44	3.93	2.62	1.31	0.79	0.26	0	0	0	0	0	0

The analysis of the results shows the following conclusions:

The concentrations of non-radiological pollutants calculated in Table 5.2.2.2 have been plotted on spatial distribution maps (Annex 14).

Given the small number of possible annual hours of operation of the facilities identified in Table 5.2.2.1, the analysis of cumulative impacts on a long-term basis is not relevant.

Therefore, only short-term impacts (2 hours/month) for pollutants that have established legal limit values for ambient air concentrations for short-term exposure was analyzed. These are limit values for the protection of human health as laid down in the Law No 104/2011 on ambient air quality.

For the assessment of the cumulative effect for short-term exposure, the conservative approach was chosen, which considers the simultaneous operation of all emission sources identified at the Cernavodă NPP site (scenario associated with the worst case scenario) (Table 5.2.2.1). Thus, the spatial distribution of non-radiological pollutant concentrations achieved for the Cernavodă NPP site in the scenario of simultaneous operation of all sources described above was superimposed with the spatial dispersion of pollutants resulting from the simultaneous operation of the two Stand-by Diesel generators units of the CTRF (Appendix 15).

Any possible differences from the dispersion profile presented in Annex 3 of the Level II Environmental Assessment [38] are generated by the different assessment methodology and the estimates incubated by it, as there is no perfect traceability.

It should be noted that the conservative approach was used to demonstrate the maximum amount of non-radioactive emissions associated with the Cernavodă NPP site.

The only pollutant for which exceedances of the limit values may occur through the contribution of the plant's sources is nitrogen dioxide (NO₂), for the other pollutants (CO, SO₂, PM₁₀) the maximum value of the concentrations obtained by modelling being below the legal limit values for the protection of human health, established by Law no.104/2011, for the protection of human health and the environment as a whole by regulating measures aimed at maintaining ambient air quality.

In the case of NO₂, the biggest impact was obtained in the "testing - all sources" scenario (the scenario associated with the most unfavorable emergency scenario), but this is a theoretical one and involves the simultaneous operation of all the combustion units on the site.

However, the conservative approach used in the dispersion modelling shows a maximum impact that will not be reached in practice, taking into account the small number (2 hours/month) in which the analysed emission sources can operate and the fact that the Diesel units will not operate simultaneously; they have been designed as redundant.

Furthermore, it has been observed that there are no exceedances of the limit values for the modelled pollutants at the nearest human receptors, thus the normal operation of the CTRF plant will have a negligible, direct, reversible, local and short-term impact on the air quality outside the Cernavodă NPP site.

Cumulative effect of radiological emissions from the Cernavodă NPP and the CTRF project

Most of the tritium activity released into the environment by CTRFs in normal operation is found in the effluent gases. As discussed in Section 1.4, the estimated annual tritium emissions from the CTRF are an order of magnitude lower than the annual emissions currently resulting from the two plant units. The results of the monitoring, presented in Section 4.2, showed that the gaseous emissions of tritium from the operation of Units 1 and 2 have an insignificant impact on the quality of the air environmental factor. Given the similarity of the exhaust systems (size of the ventilation stacks) used by Units 1 and 2 and the CTRF respectively, it can be estimated that the impact that the releases of gaseous, radioactive effluents from the CTRF will have on the air quality in the area of influence of the Cernavodă NPP will be minor, direct, local and reversible. The application of the CTRF tritium removal process is expected to gradually reduce gaseous tritium emissions from Units 1 and 2 of the Cernavodă NPP, which will be reflected in reduced levels of tritium contamination of the air in the vicinity of the plant. Therefore, the cumulative radiological impact of the operation of the CTRF and Units 1 and 2 on air quality will be positive, direct, reversible, local and long-term.

The positive environmental impact of a tritium removal plant on air quality in the area of the nuclear power plant has been practically demonstrated by decreases in tritium-specific activity within the emissions from the Wolsong Nuclear Power Plant - Korea, which were recorded after a tritium removal plant similar to the CTRF was commissioned.

5.2.3 Environmental factor soil

Construction stage

During the construction phase of the CTRF facility, potential sources of soil pollution may be accidental leakage of hydrocarbons that could result from the operation of machinery/transport equipment used during the construction period; repairs to such machinery/transport equipment in undesignated areas; and improper disposal of waste generated during the construction period.

Taking into account the aspects presented above and considering that the construction/installation works related to the CTRF plant will be of a seasonal nature, as well as through the implementation of specific prevention measures described in Chapter 7, NPP procedures and good construction practices, it is estimated that the impact generated during the construction phase on the soil environmental factor will be negligible, direct, reversible, local and short-term.

No radioactive materials are used in the construction phase of the CTRF, so any soil contamination due to planned radioactive releases or accidental releases associated with the project is excluded. For this reason it is not possible to assess the radiological impact of the CTRF on the soil environmental factor for the construction phase of the facility.

Operating stage

In the operating stage a potential source of soil and subsoil pollution is accidental fuel leakage from Stand-by Diesel-generator units.

Another potential source of contamination is also the improper handling and storage of non-radioactive waste generated from CTRF activity. However, the implementation of protective and mitigation measures, administrative and technological measures, as well as NPP procedures prevent improper waste management.

During the operation of the CTRF project, the impact of the sources described above will be negligible, directly cumulative, reversible, local and short term, given the existing facilities and equipment and the conduct of activities in compliance with all applicable NPP procedures.

From a radiological point of view, the impact of the operation of the CTRF on the soil environmental factor is due to releases of tritium from the plant, as liquid or gaseous effluents, under normal operating conditions or releases of tritium under accident conditions, which may generate, under certain conditions, radioactive contamination of the soil, as discussed in subchapter 5.5.

The results of the radiological monitoring carried out on the soil in the vicinity of the Cernavodă NPP site showed, as presented in subchapter 4.3, that tritium is the only radionuclide present in the soil that can be associated with effluent emissions from the plant, but its concentration levels are very low. Thus, taking into account that the tritium emissions from the CTRF are estimated to be an order of magnitude lower than those from Units 1 and 2, it can be stated that their effect on tritium concentrations induced in the soil in the vicinity of the plant will be insignificant.

The assessments carried out in sub-chapter 5.5 have shown that, under accident conditions at the CTRF, radioactive soil contamination is of a local nature and the effective doses that could be induced by airborne tritium concentrations subsequently generated by the presence of this soil contamination will be negligible. Under these circumstances, it can be stated that the environmental impact will be limited to areas in the immediate vicinity of the installation and will be minor, local, reversible with short-term effects.

By reducing the concentration of tritium in active plant systems, the operation of the CTRF will help minimise the volume of low and intermediate level active waste. Thus, the environmental impact due to this category of radioactive waste produced on the NPP site will be reduced.

It is also expected that the implementation of the removal process will gradually reduce tritium emissions in liquid and gaseous effluents from the Cernavodă NPP site. Thus, it can be estimated that the cumulative radiological impact of the operation of the CTRF, together with Units 1 and 2, on the soil environmental factor will be positive, local, reversible and long-term.

5.2.4 Biodiversity

Construction stage

During the construction phase, the project will not impact on protected areas as they are at least 2.5 km away. Also, indirect impacts that could occur due to degradation of air and water quality will be avoided as a result of administrative and technological mitigation measures implemented by the Contractor. Impacts on flora and fauna will be neutral, as no species of conservation value are present in the vicinity of the CTRF facility.

Construction operations will be carried out mainly during the day. However, for short periods of time, construction activities will be carried out at night requiring artificial sources of lighting. These sources will be directed towards the perimeter of the CTRF and sized in intensity so as not to cause major disturbance to wildlife in the vicinity of the CTRF site. The impact will therefore be direct, local, reversible, negligible and short-term.

Operating stage

Degradation of aquatic and terrestrial habitat can be generated by decreasing air quality levels during the operational phase of the Project. Air quality is influenced by the combustion gases of the Stand-by Diesel-generator units.

Emissions generated by Stand-by Diesel-generator sets as a result of Diesel fuel use are CO₂, SO₂ and NO_x and dust particles. Emissions from the Stand-by Diesel-generator sets modelled in subchapter 5.2.2 show that the decrease in air quality generated by the project will have a negligible impact on aquatic and terrestrial habitats.

As studies to assess the impact of activities on the Cernavodă NPP platform on biodiversity have shown, the impact on flora and fauna in the habitats around the Cernavodă NPP due to tritium releases into the environment from the two NPP units is negligible (see subchapter 4.4). As regards the impact due to radioactive releases from the CTRF, since these are an order of magnitude smaller than those from the plant, it can be estimated that the impact of normal operation of the CTRF will be negligible. Also, considering the gradual reduction of tritium emissions from the two units as a result of the application of the heavy water tritium removal process, the cumulative radiological impact of the operation of the plant and the CTRF on biodiversity will be reduced in proportion to the reduction of emissions.

In terms of radiological risk, the risks associated with accidents with significant tritium release to the atmosphere have been assessed in the Kinectrics CTRF Accident Analysis Report for Public Dose (KI CTRF-00437 Rev 05). The KI CTRF-00437 Rev05 report contains the results of the estimation of doses to the general public as a result of cover events associated with tritium emissions from anticipated operational events and internal or external events with frequencies of occurrence in the range 10⁻²-10⁻⁷ events per year. Based on the results of this analysis, as well as an assessment presented in sub-chapter 5.5, it was concluded that the radiological impact of an accident at the CTRF facility on the population and the environment in the immediate vicinity of the facility will be minor, directly cumulative, reversible and short-term.

5.2.5 Climate and climate change

This sub-chapter describes the potential contribution of the project to climate change through indirect greenhouse gas emissions and the vulnerability of the project to climate change.

Indirect greenhouse gas emissions associated with the project arise from the auxiliary project activities and energy demand.

Construction stage

In the construction stage, the release of greenhouse gas emissions from the management of the waste resulting from the implementation of the CTRF project will be negligible, as the waste

generated will be predominantly inert and emissions from the disposal of this waste are unlikely to generate significant amounts of greenhouse gases taking into account the duration of the construction phase.

Operating stage

The ancillary greenhouse gas generating activities are the transport activities for the supply of the CTRF plant and for the disposal of the waste generated by it.

By combining the transport activities for CTRF supply with those of the nuclear units, the magnitude of indirect greenhouse gas emissions from ancillary activities makes an insignificant contribution to the greenhouse gas emissions of the Cernavodă NPP.

The reduced amount of waste produced by the 26 employees who will work in shifts determine a negligible amount of greenhouse gases emission of the operating phase.

The waste management resulting from the implementation of the CTRF project will have a negligible effect on the environment in terms of greenhouse gas emissions, while selective waste collection will reduce these emissions:

- By recycling one tonne of plastic, 2,300 kg of CO₂ will not be released into the atmosphere;
- Recycling one tonne of metal will prevent the release of 1750 kg CO₂ into the atmosphere;
- Recycling one tonne of paper will prevent 795 kg CO₂ from being released into the atmosphere;
- Recycling one tonne of glass will prevent 529 kg CO₂ from being released into the atmosphere.

*Note: quantities have been estimated using a **converter for the general public and are indicative quantities**.

The electricity supply of the CTRF installation will be provided from CNE Cernavodă transformers - a nuclear power producer, thus the amount of indirect greenhouse gas emissions will be insignificant.

The vulnerability of the project to climate change was based on the predicted risks of extreme weather events presented in Chapter 4 - subchapter 4.5.

The analysis of each scenario led to the following:

Vulnerability of the project to heat waves

For the vulnerability of the project to heat waves, the worst case scenario was taken into account in which the maximum temperature could reach 49.5°C under conditions of increasing frequency and duration of heat waves.

Under such conditions, sensitive components exposed to the environment may suffer deformations due to expansion and disturbances in proper functioning. Over the long term, degradation of external components will be accelerated due to increased exposure to UV radiation.

For components inside the building, an increase in average temperature of 1°C to 2°C by 2057 will not impact on their proper functioning.

Vulnerability of the project to drought events

The risk scenarios do not highlight situations that could disrupt the proper functioning of the CTRF facility. The CTRF operates continuously, in closed circuit, recirculating 99% of the demineralised water required.

Vulnerability of the project to extreme amounts of precipitation

In the context of the aridization of the Dobrogea area, it is expected that the frequency of occurrence of rainfall will be lower, but the degree of rainfall intensity will be higher.

In such a rainfall scenario there is a risk that the rainwater drainage system will be over capacity and excess water will cause disturbances on site.

The rainfall drainage capacity of the CTRF site and the protective thresholds of the building access routes will protect from the disruption of the primary safety functions of the CTRF facility.

Vulnerability of the project to flooding by rivers and floodwaters

In the area of interest, floods may originate from the water courses represented by the Danube River, the Danube-Black Sea Canal, the Seimeni Canal, the Vițeilor Valley and the Cișmelei Valley.

In the worst case scenario where one of the two dams on the Danube would fail, the distance of more than 600 km to the CTRF site would cause downstream attenuation of the generated flood wave, so that the effects on the site would not exceed the effects due to the high waters of the Danube [15].

The hazard associated with high water levels is potential flooding of nuclear facilities and disruption of transport, communication and response routes.

The analysis of the safety margins shows a good protection of the Cernavodă NPP against the flooding of the site posed by this type of threat [15].

Vulnerability of the project in case of storms and strong winds

The project has no vulnerability in case of storms and strong winds. Furthermore, the design reserves and qualifications for other types and combinations of loads of the nuclear structures inherently provide increased resistance to strong wind.

Vulnerability of the project to landslides

The project is not located in an area considered to be at risk of landslides, as the dome-shaped landforms in the vicinity of the CTRF site and the presence of vegetation on the slopes do not allow landslides. Landslides are also caused by excess moisture in the soil, and in the area of the CTRF site, dry periods are expected to increase.

Therefore, there is an extremely low probability of landslides during the operation of the CTRF plant.

The non-existence of a vulnerability of the **project to rising sea levels, storm surges**, is given by the geographical location of the CTRF site at an altitude of over 10 m above the Black Sea plus the height of the 2 Locks of over 10 meters located on the Danube - Black Sea canal. The worst-case scenario estimates increases of up to 80 cm above current sea level.

Vulnerability of the project to cold periods

Freeze-thaw phenomena can affect the proper functioning of CTRF equipment and systems exposed to the outdoors. Direct consequences may be on ventilation systems which may be blocked by ice layer deposited on the ventilation and air grilles. Indirect consequences on the CTRF may be in the scenario of power line breaks and short circuits of the Cernavodă NPP caused by ice deposits.

Specific procedures are in place to address the abnormal situation that occurs, including the use of Stand-by Diesel generator units.

5.2.6 Noise

This sub-chapter presents the assessment of the noise generated by the project during both the construction and operation phases. For both stages, the sources and significance of possible effects are identified.

Construction stage

At this stage, there are no details on the characteristics of the construction machinery that will be used to build the project. Therefore, it is estimated that the cumulative noise level resulting during the construction phase will not exceed a level of 120 dB.

Based on this estimate, the resulting noise level at 500 m from the construction activities will not exceed 58 dB LAeq, according to the applied model. There are no residential areas within 1 km

of the site (exclusion zone), where the construction noise level will be 52 dB LAeq. Therefore, the construction phase of the project will not generate a noise level higher than the noise level recorded for the nearest residential area (sub-chapter 3.7), and will therefore have a negligible, local, short-term impact.

The noise impact on Cernavodă NPP employees will be low. Over short periods of time, noise levels may reach higher values, but without exceeding the maximum noise exposure values for workers laid down in GD No 493/2006 on minimum health and safety requirements regarding the exposure of workers to the risks arising from noise.

Operating stage

The assessment is based on the following elements:

- Noise measurements taken to determine the existing noise levels in off-site areas in the vicinity of the project;
- noise predictions, through simulation modelling, using ArcGIS Desktop 10.5.1 software and the special software CadnaA 2020, to determine the likely significant effects of the operational phase of the project on off-site receptors in Cernavodă city and Stefan cel Mare village. The model results were used to verify compliance with the noise limits specified in SR 10009: 2017 Acoustics. Assumptions were made at this stage regarding the type and location of the proposed machinery and information from the conceptual design of the CTRF was used.

The main identified sources of noise associated with the CTRF building are related to the ground level transformers, stack and ventilation equipment located on the roof of the CTRF building. Noise data for these sources are not yet available at this preliminary design stage. Therefore, noise level assumptions were created for the CTRF operating period (24/7) and these were incorporated into the model with the dimensions presented in the conceptual design. The noise level associated with the CTRF elements used in the model was calculated for different noise frequencies of 1/1 octave, being considered constant over the 3 periods - day, evening and night (Table 5.2.6.1).

The model also used the following input data: the CTRF stack height of 50 m above ground level, the CTRF building heights - 18 m above ground level (south-west) and 22 m above ground level (north-east). A solid wall (blast wall) was inserted in the model as a sound barrier around the CTRF building, with a height of 3 m, only on one side of the building.

Off-site noise receptors were modelled at 4 m above the ground. Receptors at the boundary of the Cernavodă NPP site were modelled at 1.5 m above ground level.

The simulated values for the CTRF elements, measured in dB, for each frequency are given in Table 5.2.6.1, not including the simulation of the human hearing mechanism hearing ability.

Table 5.2.6.1 Noise levels associated with CTRF elements - Sound pressure level, dB

Source/Location of CTRF noise source	31.5Hz	63Hz	125Hz	250Hz	500Hz	1000Hz	2000Hz	4000Hz	8000Hz
South-west roof (roof edge 1.5 m above roof level)	93	93	91	91	80	76	73	66	60
Northeast roof (roof edge 1.5 m above roof level)	80	80	77	76	64	59	55	47	39
Transformers (1 m from source)	50	50	100	50	50	50	50	50	50
Stack (1 m from the mouth of the stack)	97	98	112	103	96	91	84	85	76

Table 5.2.6.1 lists the noise levels at a height of 1.5 m above roof level for ventilation equipment, 1 m for transformers and 1 m above the stack outlet. These levels are measured in dB (used to measure absolute quantities), without weighting that takes into account the sensitivity of the human ear to certain frequencies. Thus, the perceived noise levels on the ground will be attenuated by applying this physiological weighting.

The noise levels at the Cernavodă NPP site boundary were modelled by adding, on top of the initial model, the tritium removal plant building together with the noise sources in it (pumps, compressors, fans). The results of this modelling are presented in Table 5.2.6.2.

Table 5.2.6.2 Simulated noise levels at the Cernavodă NPP site boundary, dB(A)

Measuring point	Sound Pressure Level Initial Cernavodă NPP	Sound Pressure Level With functional CTRF
1p	42,8	42,8
2p	41,5	41,5
3p	38,7	38,7
4p	37,9	37,9
5p	39	39,3
6p	39,7	40,4
7p	54,5	54,5
8p	58,7	58,7
9p	64,5	64,5
10p	58	58
11p	62,6	60,5
12p	54,9	54,9
13p	42,4	42,4
14p	46,5	46,8

According to Table 5.2.6.2, when the CTRF is in operation, noise levels at the Cernavodă NPP site boundary would increase by approximately 1-2 dB (representing the difference between the sound pressure level with the CTRF in operation and the initial Cernavodă NPP sound pressure level). Thus, it is observed that the cumulative noise levels with the CTRF in operation do not exceed the noise limit of 65 dB LAeq, 1h, according to SR 10009:2017 Acoustics. For these calculations, the noise sources (measurement points 1p-14p) were taken from the 2017 Level 2 Environmental Balance for Cernavodă NPP [38].

The simulation results in Table 5.2.6.2 were used to prepare 3D noise maps illustrating that the noise level associated with the CTRF project at the Cernavodă NPP site boundary does not exceed the legal limits (Figures 5.2.6.1 and 5.2.6.2).



Figure 5.2.6.1 Noise map for CTRF operation



Figure 5.2.6.2 - 3D noise map for CTRF operation

The operation of the heavy water tritium removal facility will result in noise levels increasing by less than 1 (one) decibel, therefore there will be no exceedances of the allowable noise level limits for the industry noise source. In conclusion, the noise impact is negligible, local, throughout the lifetime of the CTRF installation.

5.2.7 Socio-economic

Construction stage

Up to 100 jobs are expected to be created during the construction phase. The construction employment plan will maximise opportunities for the local community as required skills are available.

It is possible to employ a number of workers from other localities, their presence being associated with economic opportunities for the local community (e.g. renting out accommodation, the local economy will improve as a result of increased employment and spending by new employees). Thus the impact will be positive, direct, reversible, local and short term.

Operating stage

In the operational phase, around 26 jobs will be created for technical staff. Young people from local communities will be offered technical training opportunities to maximise the medium and long-term benefits. Thus the impact will be positive, direct, reversible, local and long-term.

5.2.8 Human health

Assessment of the impact of normal operation of the waste facility at Cernavodă NPP on human health.

As shown in the previous sub-chapters, under normal operating conditions, it is estimated that total tritium emissions from the CTRF can be up to 50TBq/year [14]. The average release rate under these conditions will be 1.59 MBq/s. If all the tritium activity will be released as gaseous effluents, then the maximum effective dose to a representative member of the population, estimated according to the calculation models presented by NPP in Report IR-96200-054: "Results of the monitoring of environmental factors and radioactivity levels in the Cernavodă area, period 1996-2020", revision 0 [84] (which are also valid for the CTRF, as presented in sub-chapter 3.6) will be 0.7 microSv/year.

Based on these conservative dose estimates, using the highest value of the risk coefficients, it can be estimated that annual tritium emissions from CTRF may be associated with an additional risk of 3.7×10^{-8} of cancer induction for the representative person in the population (see subsection 4.7.1). The lifetime attributable risk (RAV, Romanian for LAR), which defines the probability of premature incidence of cancer attributable to radiation exposure in a representative person in the population, is estimated, in the case of CTRF, according to the methodology of the Study for the assessment of the radiological impact on the health status of the population conducted by the National Institute of Public Health Bucharest in 2015 [94]. Thus, assuming continuous exposure of the reference person to the same level of emissions for 70 years (a hypothetical situation that is practically impossible due to the much shorter planned duration of operation of the CTRF facility), the attributable lifetime risk will be 2.55×10^{-6} . This risk is negligible compared to the overall lifetime cancer risk of between 19% and 25% for the population in Eastern European countries, according to data published by the World Health Organisation (<https://www.euro.who.int/en/health-topics/noncommunicable-diseases/cancer/news/news/2020/2/up-to-a-quarter-of-europeans-will-develop-cancer-from-prevention,-early-diagnosis,-screening-and-treatment-to-palliative-care,-countries-must-do-more>).

However, the assessment of the impact on the health of the population as a result of the operation of the CTRF must also be made in terms of the protection of environmental factors resulting from the reduction of the emission levels of units 1 and 2 of the Cernavodă NPP, with the reduction of the tritium inventory in the moderator and primary heat transport systems of the two reactors. Thus, with the implementation of the CTRF project, the annual tritium emissions from the Cernavodă NPP site will gradually decrease, which means that the cumulative risk to a representative member of the population from exposure to radiation emitted from radioactive effluents released into the environment by the plant will decrease significantly. From this perspective, the implementation of the CTRF project at the Cernavodă NPP represents an

application of the ALARA (As Low As Reasonable Achievable) principle, the aim of which is to create the conditions for a gradual reduction in the exposure of the population to ionising radiation emitted by the tritium released, under normal operating conditions, by the nuclear installations on the site.

According to the study carried out by the National Institute of Public Health in 2015, "*The normal operation of the detritiation plant brings, according to the estimates of the technical documentation, a reduction of potential diseases associated with tritium emissions in environmental factors and, consequently, a benefit for the health of the population residing in the area of influence of the Cernavodă NPP*" [94].

From a radiological point of view tritium emissions will gradually decrease as a result of the operation of CTRF plant. Thus, the analysed project, by the nature of the activities on each phase (construction and operation), cannot result in a change of disease vectors.

Assessment of the impact on human health under accident conditions at the Tritium Removal Plant of Cernavodă NPP.

In terms of radiological risk, the main operational events to be considered are unplanned releases of radioactive material into the environment, which may also result in exposures to personnel and the public.

These events may occur accidentally and may involve significant losses of heavy water from the plant or from transfer pipelines, releases of tritiated water vapour or tritium gas due to loss of facility tightness, or explosion due to hydrogen accumulations in the facility enclosure (see subsection 8.2.2).

The maximum effective doses to the population that may be induced in the vicinity of the CTRF site as a result of unplanned tritium atmospheric release events were estimated in the CTRF Accident Analysis Report for Public Dose KI CTRF-00437 Rev 05 [95]. The assessment in this report was performed, under conservative conditions, from a set of twelve scenarios based on extended events associated with tritium releases from anticipated operational events and internal or external events with occurrence frequencies in the range 10^{-2} to 10^{-7} events per year. The analysed events, classified according to the NSN-24 criteria, allowed the estimation of maximum effective dose values for the population in the vicinity of the facility, up to the border with Bulgaria (35 km from the CTRF) and Ukraine (100 km from the CTRF) (see subchapter 5.5).

According to the analysis carried out in KI CTRF-00437 Rev. 05, the highest effective dose that a person in the population may incur as a result of one of the coverage events considered is 0.45 mSv (at the boundary of the exclusion zone, 900 m from the CTRF), corresponding to an event of: Massive CD system process boundary failure - CD column and cold enclosure failure event with a probability of occurrence between 10^{-3} and 10^{-4} (see subchapter 5.5). This effective dose value represents less than one fifth of the effective dose due to annual exposure to natural radiation sources. This effective dose translates (using the risk coefficients considered in the Study for the assessment of the radiological impact on the health status of the population in the area of influence of the Cernavodă NPP in relation to the normal operation of the Cernavodă NPP waste facility (CTRF)", 2015 [94]) into an excess risk of cancer induction of up to 2.5×10^{-5} for the most exposed member of the population. As the most recent data published by the Romanian Ministry of Health (www.ms.ro/wp-content/uploads/2021/06/Infografic-CANCER-2021.pdf), show that mortality from tumours has remained at a similar level to the values of previous years (including up to 2015), its highest value in 2019 being 272.4 cases per 100,000 inhabitants (corresponding to the male statistical group), we can conclude that the risk of developing radiation-induced cancer associated with tritium exposure of a person in the population, following an accident at the CTRF, is negligible, compared to the general risk of developing cancer (which results from the Ministry of Health data as 2.7×10^{-3}), representing less than a one percent increase in risk for the most exposed person in the population.

In view of the above, it can be concluded that the radiological impact on human health for the population in the area of influence of the Cernavodă NPP as a result of the operation of the CTRF plant is negligible, both under normal operating conditions and in the event of an accident.

5.2.9 Material goods

There are no tangible assets and cultural heritage values in the proposed CTRF project area that are affected and require protection.

Construction stage

During the construction phase there is no possibility of an impact on underground heritage assets, as the nearest material assets of national importance in the Cernavodă area are located at approx. 2 km west of the construction area.

During the construction phase the CTRF will have no impact on above ground heritage assets, as all these assets are located at a distance of ca. 2-3 km north-west of the project. It will also have no impact on the landscape as there are no registered landscape assets of landscape value on the site and in its immediate vicinity.

Operating stage

It is estimated that operations during the operation of the CTRF project will have no impact on above ground physical assets, as all above ground heritage assets are located at approx. 2-3 km in the north-western part of the project.

Thus, it can be concluded that the CTRF project will have no impact on material assets and cultural heritage.

5.3 Cumulating effects with those of other existing and / or approved projects taking into account any existing environmental issues related to areas of particular environmental importance that could be affected, or the use of natural resources

The relevant projects in terms of cumulative impact analysis with the CTRF project have been presented in sub-chapter 1.2.14, Table 1.2.14.1.

For the assessment of the cumulative impact during the construction phase of the CTRF project, works that can be carried out in parallel, i.e. those related to the Intermediate Dry Spent Fuel Storage (IDSFS) project based on the phased construction of MACSTOR 200 type modules, were considered.

The project for the Refurbishment of Unit 1 of the Cernavodă NPP and the Expansion of the IDSFS with MACSTOR 400 type modules is in the regulatory procedure from an environmental point of view. According to the information currently available on the project implementation schedule, it is estimated that the construction works will not take place simultaneously with the CTRF project.

For the Project Continuation of the construction and completion of Units 3 and 4 at the Cernavodă NPP regulated by GD no.737/2013, it is currently not possible to estimate a start date for the works, so it was not taken into account in the cumulative impact assessment during the construction phase of the CTRF project.

For the **construction phase**, the following potential cumulative pathways were identified:

- Dust emissions from soil excavation works;
- Emissions of gases from machinery and means of transport to be used during the site organisation.

Taking into account the distance between these projects; the specific impact prevention and mitigation measures described in Chapter 7 and the compliance with the requirements of the applicable Cernavodă NPP permits/agreements/authorisations and procedures, it can be concluded that the impact of the CTRF-related works, when combined with that of the other works on the NPP site, will be negligible, locally and on the short term.

For the operational phase of the CTRF project, the following potential cumulative impact pathways were considered in the cumulative impact assessment:

- Radioactive emissions of tritium from CTRF activity with those from NPP activity;
- Non-radioactive emissions from CTRF-related Stand-by Diesel-generator sets with those from existing activity;
- Liquid effluents generated from the CTRF activity in view of their management by the existing plant systems.

Taking into account the results of the monitoring of the Cernavodă NPP activity presented in the previous chapters, the conclusions of the environmental impact assessment for the CTRF project presented in this chapter, and the contribution of the CTRF installation to the reduction of tritium emissions from the operation of the two NPP units, it can be concluded that the impact of the operation of the CTRF facility in combination with the other operational facilities on the NPP site (U1, U2 and IDSFS) and those expected to become operational during the lifetime of the CTRF facility (U3 and U4, where the main buildings are largely completed, followed by completion works, equipment/facility assembly) will be insignificant on a short-term basis and positive on a medium to long-term basis.

5.4 Projects / activities planned to be built / put into operation in parallel with the CTRF, whose areas of influence overlap in whole or in part with that of the project assessed during both construction and operation

The relevant projects to be implemented on the Cernavodă NPP site are presented in subchapter 1.2.14. The cumulative impact of the CTRF installation with the other relevant projects on the Cernavodă NPP site has been assessed in the previous subchapter.

The following projects are planned to be carried out in the administrative territorial area of Cernavodă, according to the information available on the Cernavodă City Hall website:

1. Cernavoda Emergency Management Centre is a future project whose location is not yet known. This centre, where emergency-related activities will be carried out, will function as a training centre. So far, a feasibility study has been carried out and the necessary funds for this investment have yet to be found.

2. Residential buildings in the northern area of Cernavodă is a future project located about 4500 m north of the Cernavodă NPP and 5200 m from the CTRF site. It would be extended over about 7 hectares and consist of 21 blocks containing 252 dwellings.

3. Cernavoda Harbour is a future project located 4200 m north-west of the Cernavodă NPP and will have an area of 20302 m². This harbour with tourist function will have pontoons and docks for ships and agreement spaces. The feasibility study and the technical project are currently being prepared.

4. Sofia Park is a future project located 4200 m north-west of the Cernavodă NPP. It will have an area of about 15000 m² and will contain pedestrian walkways, lighting system, fountain, children's playground, etc.

5. Cernavoda ecological reconstruction and afforestation is a planned activity located 4200 m north of the Cernavodă NPP which foresees the afforestation of 2 areas of 18 ha and the other of 50,6 ha, both located in the north-east and east of Cernavodă.

6. Other minor projects approved by the Cernavodă Local Council are improvements to the existing infrastructure:

- Sewerage network between the northern land area and the water treatment plant.
- Replacements of the water supply network, thermal network, electricity network and other utilities in various locations in Cernavodă;
- Rehabilitation and extension of the Central Park;
- Construction of 3 swimming pools;

- Construction of a dog shelter.

Taking into account the conclusions on the impact assessment of the CTRF project presented in this chapter, as well as the above information on future developments in the territorial area of Cernavodă, the distance to these projects, their purpose and the estimated timeframe for their implementation, it can be concluded that there will be no cumulative effects in the short, medium and long term.

5.5 Effects which may arise from accidents, unusual events or exposure of the project to natural or man-made disasters (including in a transboundary context)

In order to assess the radiological consequences of a CTRF accident on the population, a series of event scenarios involving the release of gaseous tritium and tritiated water vapour were analysed in the CTRF Accident Analysis Report for Public Dose KI CTRF-00437 Rev 05 [95]. The accident types analysed include cover events associated with tritium releases as a result of anticipated operational events and internal or external events with occurrence frequencies in the range 10^{-2} to 10^{-7} events per year. The analysed covering events classified according to the criteria of NSN-24 are presented in Table 5.5.1, together with the maximum effective dose values for the population in the vicinity of the installation and for the inhabitants in the vicinity of the border with Bulgaria (35 km from the CTRF) and Ukraine (100 km from the CTRF).

Table 5.5.1 Results of the assessment of radiological consequences of events at CTRF, according to KI CTRF-00437 Rev 05

Class event	Frequency (ev./year)	Events description	Individual dose limit (mSv)	Maximum Individual dose (mSv)	Dose at Bulgarian border ~35km (mSv)	Dose at Ukraine border ~100km (mSv)
1	$f > 10^{-2}$	CTRF process boundary leakage with early detection	0.5	$3.0 \cdot 10^{-3}$	$2.0 \cdot 10^{-7}$	$8.4 \cdot 10^{-8}$
		DTO transfer pipe leakage with early detection		$1.6 \cdot 10^{-4}$	$5.5 \cdot 10^{-8}$	$7.7 \cdot 10^{-10}$
2	$10^{-2} > f > 10^{-5}$	Leakage from CTRF process system without prompt detection	20	$1.2 \cdot 10^{-2}$	$7.8 \cdot 10^{-7}$	$3.4 \cdot 10^{-7}$
		Leak from DTO transfer line without prompt detection		$9.9 \cdot 10^{-4}$	$3.4 \cdot 10^{-7}$	$4.7 \cdot 10^{-9}$
		Massive failure of CD system process limit - LTET break event		$4.4 \cdot 10^{-2}$	$1.5 \cdot 10^{-5}$	$2.3 \cdot 10^{-7}$
		Massive DC system process limit failure - DC column and cold enclosure rupture event		$4.5 \cdot 10^{-1}$	$2.7 \cdot 10^{-5}$	$1.3 \cdot 10^{-5}$
		DTO supply tank rupture		$5.2 \cdot 10^{-2}$	$3.4 \cdot 10^{-6}$	$1.5 \cdot 10^{-6}$
		DTO transfer line rupture		$9.9 \cdot 10^{-3}$	$3.4 \cdot 10^{-6}$	$4.7 \cdot 10^{-8}$
		Design basis earthquake		$1.7 \cdot 10^{-1}$	$1.1 \cdot 10^{-5}$	$4.8 \cdot 10^{-6}$
		Severe earthquake with annual return frequency of 10^{-5}		$1.1 \cdot 10^{-1}$	$4.0 \cdot 10^{-5}$	$5.7 \cdot 10^{-7}$
3,4 BDBA	$f < 10^{-5}$	Severe event leading to non-attenuated release of DT and DTO inventory from the CTRF process system	-	$8.2 \cdot 10^{-2}$	$1.8 \cdot 10^{-4}$	$3.0 \cdot 10^{-6}$
		Very severe event leading to non-attenuated release of DT and DTO inventory from the CTRF process system and from an ITC		$2.1 \cdot 10^{-1}$	$4.7 \cdot 10^{-4}$	$7.8 \cdot 10^{-6}$

The calculation methodology used in KI CTRF-00437 Rev 05 is based on the assessment of radiological consequences using the ADDAM 1.4.2 calculation code, which allows the calculation of air and soil concentrations and doses to members of the public following a release of

radioactive material into the atmosphere. ADDAM uses Gaussian dispersion, short term, long term and fumigation models to calculate dilution factors. The program calculates individual doses along the central axis of the dispersion cloud at specified receptor heights [95].

The assessment considered only tritium in the form of tritiated water. Dose conversion factors were used for each route of exposure and age group as recommended in CSA N288.2-14. Inhalation conversion factors for HTO take into account transdermal absorption. The critical group is considered to be the highest dose intake. It results as the maximum of the calculated doses for the groups: 3-month-old child and adult. The critical location is the location (radial distance from the CTRF) at which the highest value of ground concentration is recorded at the site boundary [95]. In the report the precipitation rate is conservatively chosen with the value of 0 mm/hour to estimate the maximum effective dose.

In order to assess possible radiological consequences on environmental factors following a CTRF accident, RATEN ICN Pitesti carried out an independent assessment based on a possible initiating event constituted by an earthquake with a frequency of occurrence of 10^{-4} per year. The scenario analysed, in the hypothesis of the occurrence of this event, consists in the failure of the unqualified systems, and with the full conversion from DT to DTO.

Under the conditions considered for this scenario, the estimated maximum effective dose in KI CTRF-00437 Rev 05 for one person in the population is 0.17 mSv. Considering that this effective dose value is at least five times lower than the annual dose limit for the population due to exposure to ionising radiation from authorised practices (1mSv/year), it can be stated that the effects of this accident involving the environmental factor air are short-lived (less than one hour) and insignificant. It can also be observed that doses at a distance of approx. 35 km (border with Bulgaria) are 11 nanoSv, and at a distance of ca. 110 km (border with Ukraine) are 4.8 nanoSv. These values are insignificant compared to the doses resulting from the natural background (2.4 mSv/year, i.e. a value of 6575 nanoSv/day).

For the soil environmental factor, one consequence could be the occurrence of tritium-contaminated areas as wet deposition occurs during the passage of the pollutant cloud released as a result of the accident. In fact, as shown in IAEA-TECDOD-1738, doses including soil-based exposure pathways are not negligible when integrated over time. Unlike the calculations in KI CTRF-00437 Rev 05, which were performed using ADDAM 1.4.2, the assessment described below was performed using HotSpot v.3.1.2 (available to reviewers), but both programs rely on the Gaussian model to simulate atmospheric dispersion.

The input parameters, considered in the modelling, which are identical to those used in the KI report CTRF-00437 Rev 05, are as follows:

- Full release of tritiated deuterium inventory from non-earthquake qualified systems with 100% conversion to DTO - $2.2 \cdot 10^{15}$ Bq;
- Full release of DTO inventory from non-earthquake qualified systems with partial evaporation (10%) - $6.5 \cdot 10^{14}$ Bq;
- Emission is through the ventilation stack;
- Stack height: 50 m;
- Stack diameter: 1.95 m (slightly larger than the design diameter, but from a modelling point of view this gives conservative results).

In addition, calculations to assess soil contamination considered a rainfall rate of 1 mm/h in all regions where the pollutant cloud propagates, effluent velocity 5.1 m/s, stability class C (slightly unstable) and wind speed 3 m/s.

Table 5.5.2 shows the maximum effective dose values calculated with HotSpot in the deposition-free scenario (E0), the maximum effective dose values calculated with HotSpot in deposition scenario (E1) and the maximum ground deposition values (D1). The E1 value represents the effective dose due to inhalation exposure following the passage of the pollutant cloud.

For comparison in the table the maximum effective dose values in the no deposition scenario (E0r), taken from KI report CTRF-00437 Rev 05, have also been included.

Table 5.5.2 Modelling results for estimating ground deposition under the accident conditions analysed

Distance (km)	E ₀ (mSv)	E _{0r} (mSv)	E ₁ (mSv)	D ₁ (kBq/m ²)
0,9	1,90E-01	1,7E-01	1,10E-01	4,10E+06
1	1,60E-01		9,00E-02	3,50E+06
2	4,70E-02	4,2E-02	1,50E-02	1,00E+06
3	2,40E-02	2,3E-02	4,30E-03	4,00E+05
4	1,50E-02	1,5E-02	1,50E-03	1,80E+05
5	1,00E-02	1,1E-02	6,00E-04	8,40E+04
6	7,80E-03		2,60E-04	4,10E+04
10	3,70E-03		1,30E-05	2,80E+03
15	2,10E-03	2,9E-03	4,20E-07	1,20E+02

The effects of such an accident on the environment in the area affected by atmospheric discharges can be analysed in terms of the behaviour of radioactive contamination of environmental factors.

Unlike other radionuclides, tritium in the form of tritiated water is characterised by an increased mobility in the environment due to its uptake in natural water cycles.

Thus, it is shown in the literature (IAEA TRS 207, Tritium in some typical ecosystems, Vienna, 1981) that following the application of a tritiated water contamination pulse to the soil a number of processes will lead to its accelerated migration, such as:

- Soil water diffusion;
- Evapotranspiration loss;
- Gravitational transport of water in the soil as a result of input by precipitation or irrigation;
- Transfer in the soil-water system by capillary, hygroscopic or hydration phenomena.

The residence time of tritium in the soil depends strongly on the soil and climatic characteristics specific to the area. A co-ordinated research programme has been carried out to determine the distribution ranges of this parameter (IAEA TRS 207, Tritium in some typical ecosystems, Vienna, 1981), indicating that for agricultural environments in temperate zones, the residence time of tritium in soil can vary between 3.6 days and 14.4 days. The study concluded that most of the contamination in soil is lost through the processes described above with half-lives of a few days to several tens of days, while a minor component may persist in the soil as a result of slower exchange processes with half-lives of an order of magnitude longer.

Data on the dynamics of tritium migration phenomena in soil are confirmed by the more recent report, IAEA-TECDOD-1738, which shows that the decrease in activity in temperate environments implies half-lives between 10 and 100 days.

To visualise the dynamics of the evolution of tritium concentration in soil following acute contamination, a simulation was performed using a half-life of 10 days for fast exchange events and a half-life of 100 days for slow events, where the fast fraction was taken as 90% (0.9:0.1 curve) and 99% (0.99:0.01 curve) respectively in Figure 5.5.1.



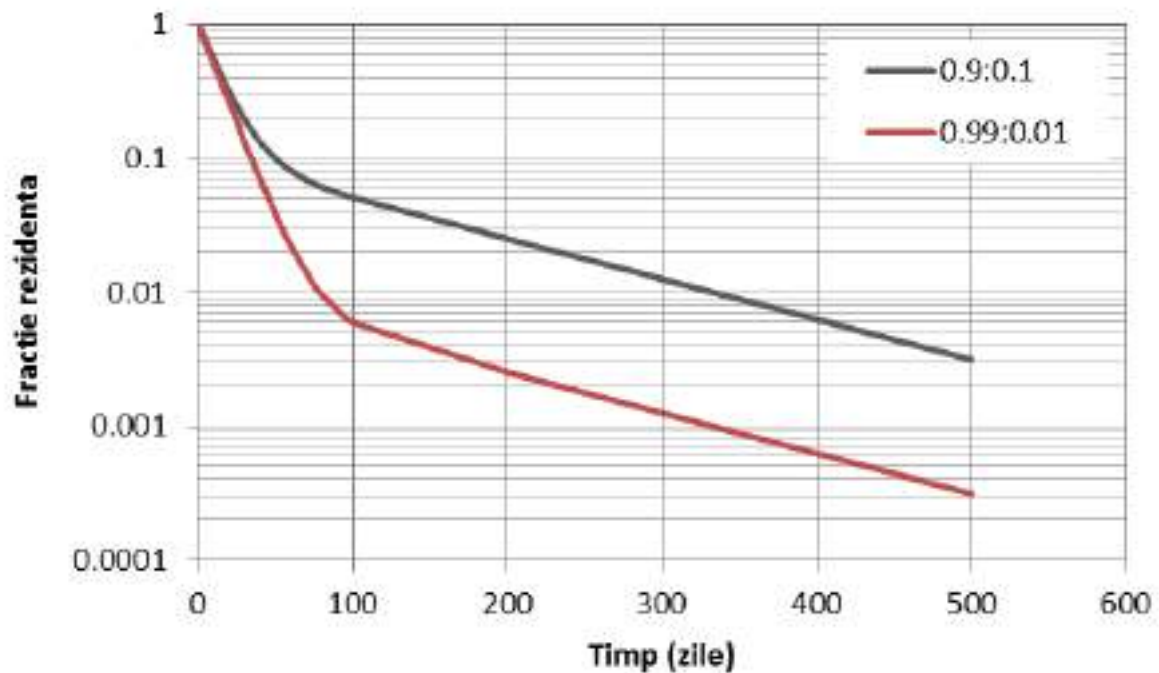

Figure 5.5.1 Time variation of tritium residual fraction following a Severe soil contamination

*(fracție rezidentă- residual fraction; timp (zile)- time (days))

It can be seen that during the first 100 days the main fraction of activity is lost, which is characterised by rapid exchange phenomena, and a minor fraction of activity persists in the soil for several years. This conclusion is also supported by other data in the literature, where it is shown that for tritium, soil is not a compartment for accumulation of contamination (see www.irsn.fr/EN/Research/publications-documentation/radionuclides-sheets/environment/Documents/Tritium_UK.pdf). It should also be borne in mind that for tritium as tritiated water, the inhalation dose coefficient is very low (1.8×10^{-11} Sv/Bq), which means that the actual doses that could be induced by airborne tritium concentrations, subsequently generated by the presence of contamination on the ground, will be negligible compared to the calculated doses when the pollutant cloud passes. The effective dose, which includes exposure to tritium contaminating the soil, will not exceed the value conservatively calculated in the Kinetics report and independently verified by RATEN ICN Pitesti, i.e. columns E0 and E0R. Under these conditions it can be stated that the environmental impact in the areas in the immediate vicinity of the installation will be negligible in the short term.

5.6 Cross-border nature - impact on neighboring states: Bulgaria, Ukraine and the Republic of Moldova

Under normal operating conditions, the radiological impact, associated with tritium emissions from the CTRF, on the population in the vicinity has been estimated as a maximum annual effective dose of 0.7 microSv/year. This effective dose value is estimated for a person residing at the boundary of the exclusion zone.

Under these conditions it can be stated with certainty that the emissions associated with the normal operation of the CTRF have no significant effect on people in neighbouring countries. Furthermore, it has been shown that after the commissioning of the CTRF, even after the first year of operation, a reduction of up to 17% of tritium emissions from Unit 1 of the Cernavodă NPP can be achieved, which will mean a proportional reduction of the effective dose to the population.

Radiological safety analyses for accident situations at the CTRF show that the effective doses to individuals in the population on the territory of Bulgaria are lower than 0.47 microSv [95] (for the

most severe event considered in the analysis), while the average effective dose due to exposure to the natural radiation background is 2.4 milliSv/year [108], i.e. 6.7 microSv/day.

Thus, as a result of a severe accident at CTRF, a person in Bulgaria cannot receive a dose higher than 0.02% of the annual dose, which is less than 7.2% of the effective daily dose due to exposure to the natural background radiation. Similarly, it is indicated that the maximum dose to a person in the population of Ukraine or the Republic of Moldova (located at least 100 km from the CTRF site) is 7.8 nanoSv, which corresponds to a fraction of 0.12% of the effective daily dose due to exposure to the natural background radiation. Under these conditions, it can be stated that the radiological effects of an accident at the CTRF on the population of neighbouring countries are insignificant.

Final conclusions

The radiological impact on environmental factors associated with the operation of the CTRF is due to tritium emissions in the form of liquid and gaseous effluents from the plant. These emissions have been estimated by the CTRF designer at a level that is an order of magnitude below that currently achieved by the combined emissions of Units 1 and 2. From this point of view, the radiological impact on the environment due solely to the operation of the CTRF was estimated to be insignificant, local and with short-term effects. However, as the operation of the CTRF will gradually reduce the tritium concentration in the moderator and primary heat transfer systems of Units 1 and 2, which will create the conditions for a corresponding reduction in tritium emissions from the site, it can be estimated that the cumulative radiological impact associated with the operation of the CTRF and the two units of the plant will be positive, local and with long-term effects.

The non-radiological impact on environmental factors, both direct and cumulative, will be negligible, local, reversible and short term, taking into account the location of the CTRF in the NPP perimeter, the small size of the tritium removal facility, the connection to NPP utilities and the application of NPP procedures for chemical and waste management.

6. DESCRIPTION OF FORECASTING METHODS USED TO IDENTIFY AND ASSESS SIGNIFICANT EFFECTS ON THE ENVIRONMENT, INCLUDING DETAILS OF DIFFICULTIES ENCOUNTERED

This chapter describes the methods used to estimate pollutant emissions, theoretical calculations, and those used to assess the significance of the impact. The difficulties encountered in drafting this Report are also briefly presented.

6.1 Emission estimation methodologies

6.1.1 Estimation of radioactive emissions

Construction stage

From the information presented in the previous chapters, results that for the construction phase of the CTRF installation no emissions of liquid or gaseous radioactive effluents are anticipated, as no radioactive materials are used in the construction of the installation.

Operating stage

Radioactive releases associated with CTRF operation are estimated in document 79-38500-TR-CTRF 001, edition 2014- Evaluation of Tritium Release for CTRF Normal Operation [14]. For the purpose of this report the CTRF release data have been extracted from the above mentioned reference.

6.1.2 Estimation of non-radioactive emissions

Construction stage

The estimation of non-radiologic emissions (NO_x, CO, CO, PM₁₀, PM_{2,5}) for the construction phase was performed according to Order 3299/2012 [10] - mobile sources represented by the operation of mobile powered machinery and equipment, code NFR 1.A.2.f.ii - Non-road mobile sources and equipment (in the industrial field) and mobile sources represented by vehicle traffic

on the installation site, code NFR 1.A.3.b.ii and code NFR 1.A.3 .b.iii and EMEP/EEA air pollutant emission inventory guidebook - Publications Office of the European Union, 2019 [9], taking into account the need for 16 pieces of equipment, machinery and heavy vehicles, used in the site phase for a duration of 18 months.

Operating stage

For the evaluation of the emissions related to the 2 Diesel groups - backup generators, the methodology recommended by Order 3299/2012 - 'Activities in code category NFR 1.A.4 Stationary low power source burning' and EMEP/EEA 2019 [9] was used.

For the waste disposal transport activities has been calculated, a necessary distance of 3740 km, which will be crossed by truck category vehicles. For the transport activities necessary to supply diesel fuel to the 2 diesel generators - backup generator, has been estimated a consumption of 10% of the total consumption for 3740 km. The emission calculation method for transport activities was carried out in accordance with Order 3299/2012 [10] - „Activities in code category NFR 1.A.3.b.i-iv Road transport" and EMEP/EEA 2019 [9].

6.2 Methodologies for modeling pollutant dispersion

6.2.1 Dispersion of radioactive pollutants

Modeling of the atmospheric dispersion of tritium emitted in the form of gaseous effluents was performed using a simple Gaussian statistical model [3] using, conservatively, to calculate the exposure of the representative person in the population, the values of the maximum dispersion factors, determined using this model. The conservatism of these dispersion factors was assessed in a 2012 study using a Gaussian model with special building effect routines (ISC-PRIME) [3], and the recommendations of this study were to determine the experimental factors of dispersion based on monitoring data on gaseous effluent emissions and tritium concentrations in the environment, with which to verify the results of mathematical models.

For the purpose of this report, calculations of dispersion factors have been performed using the PC-CREAM calculation code which is also based on the Gaussian model (see Chapter 1).

Dispersion calculations for estimating accidental personnel exposure to CTRF were performed using the HotSpot calculation program [99]. The atmospheric conditions considered in the modeling were chosen conservatively, so as to maximize the radiological effects on the personnel. The calculation of atmospheric, dispersion with the aim of assessing the radiological consequences on the population, as a result of an accident at CTRF, was carried out within the dispersion module of the ADDAM calculation program [95].

The dispersion of radioactive pollutants associated with liquid effluent emissions was assessed by calculating the dilution factor as the ratio of the average effluent concentration at the point of evacuation, to the average concentration at the point of water use. Thus, for the discharge of effluents into the Danube - Black Sea Canal, which does not have a significant flow for diluting liquid discharges, the dilution factor is considered unitary, while for discharge into the Danube, the dilution factor is the inverse of the average discharge rate of liquid effluents.

6.2.2 Dispersion of non-radioactive pollutants

The dispersion factors for the emissions from the Diesel-backup generator sets can be calculated using software available online (<https://www.wkcgroup.com/toolsroom/online-air-dispersion-model/>). This software was developed by the WKC Group based on the principles of Gaussian plume dispersion.

The Gaussian plume dispersion model allows the calculation of the potential concentration of pollutants in the wind direction, of a source following five important steps:

1. Determine the atmospheric stability class;
2. Calculate wind speed at the stack height;
3. Calculate plume rise;
4. Determine dispersion parameters σ_y and σ_z ;
5. Calculate downwind pollutant concentration.

The Gaussian dispersion equation used to calculate the downwind pollutant concentration from some source is as follows:

$$C(x, y, z) = \frac{Q}{2\pi\bar{u}\sigma_y\sigma_z} \left(\exp\left\{-\frac{y^2}{2\sigma_y^2}\right\} \right) \left(\exp\left\{-\frac{(z-H)^2}{2\sigma_z^2}\right\} + \exp\left\{-\frac{(z+H)^2}{2\sigma_z^2}\right\} \right)$$

where:

- C** = pollutant concentration (g / m³),
- Q** = emission rate (g / s),
- π** = 3.141593,
- U_s** = average wind speed at stack height (m / s),
- σ_y** = lateral dispersion parameter (m),
- σ_z** = vertical dispersion parameter (m),
- H_s** = effective stack height.

Based on the input provided in the previous 5 steps, the pollutant concentration at the site of the receptor was determined.

The existing situation regarding non-radiological atmospheric emissions at the Cernavodă NPP site was translated into spatial distribution maps of pollutant concentrations, made using QGIS software. Concentrations were then plotted in QGIS software.

6.2.3 Noise assessment method

The methodology applied for noise assessment includes: establishing the noise level, evaluated by in situ measurements (Bruel & Kjaer 2250 sound level meter, class 1, calibrated and metrologically verified), identification of noise generating sources, development of a model for calculating the acoustic zoning and preparation of noise maps.

For measurements in situ the noise levels were set to be recorded continuously over 24 hours, every 1 second.

The sound level meters were configured to record the noise descriptors LA_{eq}, LA₉₀, L_{max} (fast) and LA₁₀. Noise measurements were made using a Class 1 sound level meter under free field conditions more than 3.5 m away from any reflective surface other than the ground.

Acoustic modelling was carried out with specialised CadnaA 2020 software incorporating ISO 9613 - Part 2 methodology. The model was built based on the measurement results, site-specific noise limits and construction characteristics of the NPP site.

The noise assessment used specialized software to develop noise mapping, Predictor - LimA, software recognized at European Union level for its accuracy and speed of calculation. The standard used for the industrial source noise map is the Common Noise Assessment methods (CNOSSOS-EU), as laid down in the European Directive 49/2002/END on noise mapping of industrial sources.

6.3 Uncertainty about the precise details of the project and its impact on the environment

Radiological impact assessments on the environment as a result of the implementation of the CTRF project were made based on data on the impact due to the operation of the plant, so far, by extrapolating it to reduce global tritium emissions of Cernavodă NPP, as a result of CTRF operation.

The anticipated emissions associated with the operation of the CTRF were assessed on the basis of the operational experience of other similar installations, and the cumulative emissions of the CTRF and the two CANDU units in operation after the first year of operation of the CTRF were conservatively estimated by applying the lowest tritium removal factor considered by the designer.

The model for calculating the exposure of the representative person in the population and the assessments of the radiological consequences on the environment and the population, as a result of an accident at CTRF, use conservative assumptions, so that the estimation results cover the worst case situation.

From a non-radiologic point of view, the estimates of greenhouse gas emissions and the impact of potential negative effects have been made on the basis of conservative assumptions that cover even the most unfavorable situation.

The estimation of emissions, effluents and wastes was based on information from the CTRF Plant Concept Design.

6.4 Difficulties in processing the data needed to predict and evaluate the effects

From a radiological impact point of view, the uncertainties in assessing and forecasting the environmental impact of the operation of the CTRF in combination with future on-site projects lie in the complexity of these nuclear activities and the uncertainties in the accuracy of the data until their technical solutions are approved.

6.5 Basis for assessing the significance and significance of the impact

Chapter 5 of this report has analysed and presented the potentially significant effects and the results of the environmental impact assessment for each environmental factor, both during construction and during operation.

For the decommissioning phase, an environmental impact assessment, i.e. a description of the significant effects, has not been carried out, given the information presented in subchapter 1.4.4.

Cumulative impact assessment methodology

The cumulative impact assessment was performed taking into account all existing or planned developments with which the project may have cumulative effects on environmental factors, in all 2 phases of the project (construction and operation), respectively the operation of the 2 Units (U1 and U2), with all existing facilities and future projects: expansion of the Intermediate Storage Facility for Spent Fuel (DICA), continuation of works for Units U3 and U4 and Refurbishment of U1.

The projects analyzed to identify simultaneous effects were selected on the basis of existing information on the start of construction, the location of the project, the implementation phases, as well as the functional characteristics of these projects.

Simultaneous effects analysis was performed following the method potential source of contamination (pollutants) - migration path - receiver. This method has been applied to identify environmental factors simultaneously affected by pollutants emitted by different sources of contamination.

During the construction phase, the sources of potential contamination for each environmental factor were considered for each individual project analysed. Based on the source-pathway-receptor model, only one environmental factor was identified, namely air, which could generate a cumulative impact during this phase of the project. To assess this factor, the potential emission sources, pathways and potential receptors (population, employees, biodiversity) and mitigation measures envisaged in each identified project were analysed.

The same model was used in the operational phase, and air was identified as a possible cumulative impact-generating environmental factor. In its analysis, emissions from the CTRF backup diesel-generator sets, the backup and emergency diesel-generator sets of NPPs U1 and U2, and the start-up thermal power plant were considered. The analysis included the test schedule of these generators and simulated several scenarios of combined operation of these sources. The simulation methods for these scenarios are presented in subchapter 6.2.2.

From a radiological point of view, the environmental impact associated with the operation of the CTRF is due to emissions of gaseous and liquid effluents containing tritium. For gaseous effluents, the emission paths from the CTRF and Units 1 and 2 are physically separated (consisting of the ventilation stacks of each of the plants). The physical dimensions of the three stacks are similar, which makes the conditions for atmospheric dispersion of emissions similar due to their proximity. For liquid effluents, their emission is via a common path.

Based on the above, the assessment of the cumulative radiological impact of the operation of the CTRF and Units 1 and 2 was carried out by considering the following sources:

- Gaseous, cumulative tritium emissions from CTRF and NPP activity;
- Tritium discharges in the form of liquid effluents generated as a result of the operation of the CTRF and the operation of Units 1 and 2.

As shown in the previous chapters, the results of the environmental radioactivity monitoring carried out at the Cernavodă NPP showed that the environmental impact due to radioactive effluent emissions from Units 1 and 2 was insignificant, as environmental factors were not significantly affected by these emissions over time. As the estimated tritium emissions from the CTRF are an order of magnitude lower than those from Units 1 and 2, the cumulative environmental impact will also be insignificant.

Residual impact assessment methodology

The residual impact was assessed as that impact remaining after all reasonable measures have been taken to avoid or reduce negative effects for each proposed activity.

The residual impact assessment was developed to identify additional measures to limit the negative effects on the environment, that might have persisted after the application of measures to prevent and mitigate the possible negative effects of the project.

Following the evaluation presented in Chapter 5 and considering all prevention and mitigation measures, as outlined in Chapter 7, it can be concluded that the potential residual impact is insignificant.

7. DESCRIPTION OF THE TARGETED MEASURES FORESEEN TO AVOID, PREVENT, REDUCE OR WHERE POSSIBLE OFFSET ANY IDENTIFIED SIGNIFICANT ADVERSE ENVIRONMENTAL EFFECTS AND A DESCRIPTION OF ANY PROPOSED MONITORING MEASURES

This chapter describes the avoidance, prevention, and reduction measures implemented under the CTRF Project to address each form of impact identified in Chapter 5. It describes how significant adverse effects on the environment can be avoided, prevented, reduced or offset and refers to both at the construction stage, as well as at the operation stage.

Furthermore, it presents how the integration of the monitoring measures specific to the CTRF facility will be carried out within the framework of the environmental radioactivity monitoring programme at Cernavodă NPP.

7.1 Measures taken into account since the choice of alternatives

Cernavodă NPP analyzed and evaluated several alternatives to heavy water tritium removal, eliminating those that cause significant environmental impacts.

The selected alternative provides for the implementation of the CTRF project on the NPP site, a project which, once implemented, will lead to a decrease in tritium discharges into effluents, with a positive impact on the protection of the population and the environment.

7.2 Actions to avoid, prevent, reduce or, if possible, offset any significant adverse effects identified on the environment considered at all stages of construction, operation and decommissioning

The actions are detailed in Table 7.2.1 for each environmental factor, identified as potentially affected by the CTRF project in the construction and operation stages.

Table 7.2.1 Actions to avoid, prevent, reduce or compensate for any significant adverse effects identified

Factor of environment	Actions
Construction stage	
Water	Avoiding/eliminating discharges of wastewater into surface waters during construction works;

	<p>The washing of the wheels of vehicles at the exit of the site organisation will be done in a specially designated area;</p> <p>The use by the personnel of the existing sanitary facilities of the Cernavodă NPP and/or the ecological toilets.</p> <p>Ensuring proper maintenance of the machinery used on site so as to prevent accidental leakage of lubricants and fuels.</p> <p>The storage and use of hazardous substances will be appropriate (according to CNE procedures, described in Chapter 1, subchapter 1.2.5).</p> <p>Sorting and storage of wastes in specially designated areas to avoid dissolution and carry-over by storm/river water.</p> <p>Repairs and maintenance work on machinery and vehicles (oil changes, greasing, etc.) shall be carried out by authorized service units. Such work is prohibited on the site.</p> <p>At the beginning of the work and throughout the work, the staff involved in the work must be trained in the following aspects:</p> <ul style="list-style-type: none"> - general environmental protection conditions; - waste management; - how to act in the event of accidental pollution; - maintenance of machinery; - keeping the worksite clean. <p>The site organisation will be adequately equipped with specific absorbent materials for each type of material/substance that may cause pollution as a result of improper management.</p>
Air	<p>The transport of powdery materials will be carried out using covered means of transport to avoid the generation of dust.</p> <p>Ensuring adequate moisture content of disturbed land surfaces and soil stockpiles temporarily stored for backfilling in order to limit dust emissions as much as possible.</p> <p>Washing paved surfaces periodically or whenever necessary.</p> <p>Limiting travel speeds for vehicles on site so that re-suspension of particles from unpaved or disturbed surfaces is minimised.</p> <p>Ensuring appropriate maintenance of machinery used on site so that emissions from the combustion of fuels for their operation do not exceed the limits approved in the technical book.</p> <p>Efficient scheduling of transport activities so as to avoid overcrowding of the site and unjustified manoeuvring of machinery/vehicles.</p> <p>Carrying out only in favourable weather conditions activities with a potential negative impact on the environment. Excavation, earthworks or backfilling in strong windy conditions will be prohibited.</p> <p>Vehicles wheels will be cleaned when leaving the site on public roads.</p> <p>Machinery engines will be switched off during periods when they are not engaged in work.</p> <p>Vehicle engines will be switched off during periods when materials are being unloaded.</p>

	<p>Reduce fall heights from material transfer activities, such as the unloading height of dust-generating materials (soil, aggregates).</p> <p>Efficient planning of movements/supply of materials/waste management so that greenhouse gas emissions are minimised.</p>
Soil	<p>Establish travel routes for vehicles and construction equipment on paved access roads, and in situations where this is not possible, the speed will be reduced so that the disturbed ground surface is reduced to a minimum.</p> <p>Periodic inspections of machinery / vehicles to prevent / reduce the risk of accidental spillage of lubricants / fuels.</p> <p>Parking and emergency maintenance of vehicles / equipment will be performed only on concrete platforms. Repairs to machinery / vehicles shall be carried out by authorised economic operators.</p> <p>Arrangement of appropriate spaces, equipped with suitable containers for the collection and temporary storage by category of waste generated during the execution period; the waste will be recovered / disposed of by authorized companies (according to the NPP procedures).</p> <p>It is forbidden to spill used oils, fuels, untreated wastewater on the ground. In case of accidental spills, absorbent materials will be used.</p> <p>Avoiding the direct placement on the ground of construction materials and waste resulting from the works.</p> <p>The storage and use of hazardous substances shall be in accordance with the NPP procedures described in Chapter 1, Subchapter 1.2.5.</p>
Noise and vibration	<p>Apply best available techniques and best management practices to minimize, at source, noise and vibration generated by construction activities, wherever possible (e.g. observing machine work schedules at each stage); choosing and using the optimal roads / routes (the shortest, avoiding as much as possible the urban agglomerations)).</p> <p>Personal protective equipment will be used for workers in high noise areas.</p>
Operating stage	
Air	<p>Coordinating the transport activities required for the supply of CTRF and waste management with those for units U1 and U2, so that the volume of emissions is kept to a minimum.</p> <p>From a radiological point of view, the normal operation of the CTRF installation will have a positive, direct impact on the entire service life on the air environment factor by reducing tritium emissions from U1 and U2.</p>

For the Idecommissioning stage, the specific measures to prevent and mitigate the impact for each environmental factor will be established after going through the environmental impact assessment procedure based on a decommissioning specific project (see subchapter 1.4.4).

7.3 Climate change adaptation measures

Based on the vulnerabilities identified in Subchapter 5.5, the measures needed to adapt to climate change will be the use of building materials with increased resistance to UV radiation, for the exterior of the CTRF building. The location of ventilation and ventilation grilles, will be so that the phenomenon of freeze-thaw during cold periods, does not cause blockages of the ventilation system.

7.4 Residual impact, remaining after all mitigation measures have been taken

The negative effects of the project are limited in time, occur over small areas and on low/medium sensitivity receptors, and are mitigated through the implementation of avoidance/ prevention/ reduction, administrative and technological measures outlined in the report. Therefore, the residual impact is insignificant.

7.5 Measures both in terms of radiological impact and in terms of non-radiological impact

No significant negative impact on the environment resulting from the operation of the CTRF project was identified.

The Project provides equipment and facilities for: efficiency and controlling technological processes, controlling and reducing emissions, noise and vibration, soil and subsoil protection, waste management, fire protection and prevention.

Thus, in order to reduce the impact on the surface water (emission of liquid effluents), a number of measures have been foreseen since the design phase (see subchapter 1.3.4).

In order to reduce the impact on the environmental factor air and soil, a number of measures have been foreseen already since the design phase (see subchapter 1.3.4).

Radiation protection is also ensured by specific administrative and organisational actions under normal operating conditions, which include: training of staff on technical and safety aspects in the CTRF project related to the tritium handling, and the establishment of the individual personnel dosimetry system [2]. Administrative and organisational measures are also foreseen in case of an accident. All these actions will be described in Chapter 8.

7.6 Monitoring actions for environmental factors for which a significant adverse effect has been identified

Monitoring of the quality of environmental factors will be necessary both in the operation phase and in the decommissioning stage of the CTRF installation in accordance with the legislative provisions.

During the operation phase, the plant's existing environmental radioactivity monitoring program will be updated to include the monitoring of the integrated environmental impact generated by the CTRF operation. This program will be carried out according to the procedures approved by CNCAN.

In January 2019, CNCAN approved the 3rd revision of the Routine Monitoring Program for Environmental Radioactivity for Cernavodă NPP, (document SI-01365-RP015), in which the responsibilities of personnel involved in environmental radioactivity monitoring at the Cernavodă NPP were completed and the sampling locations for infiltration water samples in the vicinity of DICA and DIDSR were updated [84].

The environmental radioactivity monitoring program is designed to meet the following objectives under normal nuclear site operating conditions [104]:

- to measure radionuclide concentrations in environmental factors and to assess the variation of radioactivity levels in area-specific food chains that may change due to the operation of the nuclear facility;
- demonstrate the effectiveness of source control, effluent control and effluent monitoring based on environmental measurements;
- to provide data to assess the dose to a member of the critical group and the collective dose to the population resulting from the operation of the Cernavodă NPP nuclear facilities;
- to validate the models and parameters used in the calculations of derived release limits;
- to support data to assist in the development and evaluation of models and methodologies describing the movement of radionuclides in the environment.

With the implementation of the CTRF project, the environmental radioactivity monitoring programme will be updated to include locations and possibly monitoring methods specific to the new facility with potential impact on environmental factors.

The radioactive effluent monitoring program of Unit 1 and 2 will be extended to include emissions from the CTRF as presented in subchapter 1.4.11. The maximum effective doses attributable to the representative population will be estimated on the basis of tritium emissions from the CTRF, using calculation models similar to those applied for Units 1 and 2 of the Cernavodă NPP and to be approved by CNCAN.

The effluent samples will be collected by the CTRF operating staff and analyzed by the dosimetry laboratory of Cernavodă NPP. Monitoring and reporting of radioactive effluents related to the operation of the NPP will also include data from the CTRF [104].

NPP has also implemented a physico-chemical monitoring program for non-radioactive liquid effluents, applied for U 1 and U 2 in normal operation, established by the Water Management Authorization according to Authorization no. 58 / 07.2021, No. 72 of 06.09.2021 for Cernavodă NPP U1 and U2.

For the CTRF project, the monitoring will be done by the Cernavodă NPP for the construction phase, the final monitoring program to be established by the Environmental Permit issued for the CTRF project.

Monitoring of environmental factors during the operation of the CTRF plant will be carried out in accordance with the Cernavodă NPP Monitoring Programmes approved by the competent authorities.

For the decommissioning stage, the environmental impact assessment procedure will be followed, according to the legislation in force at the time, this procedure establishing the requirements of the authorities for monitoring environmental factors.

The responsibility of preparing, implementing and ensuring the necessary resources for fulfilling the monitoring objectives of the CTRF installation, belongs to Cernavodă NPP.

8. DESCRIPTION OF THE POSSIBLE SIGNIFICANT ADVERSE EFFECTS OF THE PROJECT ON THE ENVIRONMENT AS A RESULT OF THE PROJECT'S VULNERABILITY TO THE RISKS OF MAJOR ACCIDENTS AND / OR DISASTERS RELEVANT TO THE PROJECT IN QUESTION

The activity of Cernavodă NPP is in accordance with the provisions of Law 59/2016, on the control of major-accident hazards involving dangerous substances the NPP location being classified as a high level. According to Law 59/2016 "The operator of a high-level facility is required to draw up a safety report in order to demonstrate that major accident hazards and possible major accident scenarios have been identified and that the necessary measures have been taken to prevent such accidents and to limit their consequences for human health and the environment". The Safety Report (SEVESO) has been prepared for this purpose. This report establishes the rules and responsibilities for the prevention of major accidents [18].

The SEVESO Safety Report was revised in 2021, one of the reasons being the inclusion of the risk analysis for the CTRF project. The risks associated with carrying out CTRF activities are identified, assessed, recorded and measures are taken to prevent / minimize their occurrence by implementing a risk management process.

Following the revision of the SEVESO Safety Report, by including the risk analysis for CTRF, the On-site Emergency Plan of the NPP was revised, elaborated in accordance with the MIA Order 156/2017 by including the response to the risks identified in the SEVESO Risk Report.

From a radiological point of view, the risks associated with the occurrence of accidents with significant tritium emissions to the atmosphere have been assessed in the report "Kinectrics CTRF Accident Analysis Report for Public Dose". This analysis was carried out in its initially in

2014 and has undergone a number of revisions and is reported in KI report CTRF-00437 Rev 05, as considered for the purposes of this Report.

The KI report CTRF-00437 Rev 05 contains the results of the estimation of doses to the population due to bounding events associated with tritium emissions from anticipated operational events and internal or external events with frequencies of occurrence in the range 10^{-2} to 10^{-7} events per year. The analysed events are classified according to the criteria of NSN-24, and the assessment results include the maximum effective dose values for the population in the vicinity of the facility up to the border with Bulgaria (35 km from CTRF) and Ukraine (110 km from CTRF).

8.1 Assessing the risks associated with activities that present major-accident hazards involving hazardous substances

The assessment of the amplitude and severity of the consequences of the identified major accidents is made in order to provide data for on-site and off-site emergency planning, according to the provisions of Law 59/2016.

In order to assess the magnitude and severity of the consequences of major accidents identified in the Safety Report (SEVESO), the authors of the report used different methods of risk assessment and impact analysis by modeling scenarios of major accidents such as fires, explosions and toxic dispersions.

Preliminary Hazard Analysis (PHA) is a method of qualitative risk analysis, applied when detailed design information is not available. The method is used to identify hazards, risks and possible triggers in the early stages of the project. Thus, the safety requirements for the analyzed system and the incidents with the highest probability of occurrence are established as soon as possible in order to be able to make the right decisions on risk mitigation measures.

This method was used in the SEVESO report by its authors to analyze the potential risks of hazardous substances used by CTRF, namely hydrogen, oxygen and diesel. Below are some relevant aspects, taken from the SEVESO Report, rev.1 of 2021.

Hydrogen is present in the CTRF plant in its 3 forms - protium, deuterium and tritium, the latter being the radioactive isotope of hydrogen. Following potential releases of hydrogen, there is a risk of explosion (up to 160 Nm^3 isotopes in the plant).

Oxygen is used during equipment maintenance / cleaning periods. The maximum quantity stored in cylinders outside the building is 63 kg (16 cylinders) and the flow rate used in the installation is a maximum of $2.3 \text{ Nm}^3 / \text{h}$.

Diesel will be stored in 2 tanks of 1.5 tonnes each (3 tonnes in total), designed and installed with means of prevention and collection of leaks. The tanks will have cathodic protection against corrosion, inspection program, peripheral collection enclosure which is emptied by pumping if necessary.

On the site of the CTRF installation, these dangerous substances will be present in quantities less than 2% compared to the relevant quantities for the classification of the sites - the minimum threshold provided in Law no. 59/2016 Annex 1, Part 1 and Part 2 [18].

Conclusions on the preliminary risk analysis for the CTRF project

The qualitative risk analysis shows that the risk of major accidents at the CTRF site is a moderate risk. This is due to the relatively small amounts of hazardous substances present and the existing protection measures: retention vaults, protected tanks (concrete constructions, insulation, etc.), protected surfaces, leak collection enclosures, automated flow control, detection sensors, compliance with working procedures and protection norms. Also, in case of an event, which leads to an emergency situation, specific procedures are in place to guide response actions.

Scenarios that may have major consequences, identified following the preliminary risk analysis, have been subject to quantitative risk analysis in the SEVESO Report. The results of this analysis are presented in Table 8.1.1 [18].

Table 8.1.1 Description of major accident scenarios identified and selected in the Preliminary Hazards Assessment - PHA analysis, with a summary of the triggering events for the proposed situation (with Detritiation Installation)

Scenario code	Scenario	Summary of events that may play a role in triggering each of the scenarios - Causes	Effects
N. HEAVY WATER TRITIUM REMOVAL FACILITY			
PHA evaluation for the hydrogen circuit in the installation and for the oxygen cylinders serving the heavy water tritium removal facility.			
N.2	Damage to pipes between LPCE and CD1 and hydrogen leakage	Very large earthquake / construction of broken elements / Pipeline rupture or cracking	- hydrogen (deuterium) leaks inside the building, fires or explosions
N.6	Breaking the CD 1 cryogenic distillation column and failure of unqualified systems	Very large earthquake	- hydrogen (deuterium) leaks inside the building, fires or explosions
N.38	Explosion of an oxygen cylinder	Defective construction material External fire	- effects of overpressure and projectiles; -possible domino effects on other cylinders in the depot

Scenario N.2. Damage to pipes between LPCE and CD1 and hydrogen leakage (inside the building) - Seismic event with a return frequency of 1E-05 / year, resulting in loss of forced ventilation and failure of seismically unqualified systems.

The scenario involves the collapse of construction elements and damage, as a result of an earthquake, with a return frequency of 1E-05 / year, with the following consequences: rupture of the connecting pipe between column 3 of the Liquid Catalytic isotope Exchange System (LPCE) and column CD1 cryogenic distillation, hydrogen (deuterium) leaks terminate from the pipe in 10 minutes, until the isolating system comes into operation, the forced ventilation system malfunctions and the natural hydrogen ventilation outside the building by opening the ventilation louvers (5 seconds after event).

The impact of such scenarios is low due to existing prevention measures and the very short time that the hydrogen cloud (deuterium) formed is detonable.

The consequences of such hydrogen (deuterium) leaks can be significant if the detonation occurs, causing significant damage inside the CTRF building.

Scenario N.6. Breaking of cryogenic distillation CD 1 column and failure of unqualified systems - Seismic event with return frequency 1E-05 / year, resulting in rupture of cryogenic distillation CD1 column and failure of unqualified systems.

The scenario involves the collapse of construction elements due to a very large earthquake, with a return frequency of 1E-05 / year, with the following consequences: rupture of cryogenic distillation column 1 and failure of unqualified systems, leakage of total hydrogen (deuterium) from column (17.1 kg) inside the building, fire or explosion. It is assumed that the forced ventilation system remains functional and in a relatively short time the hydrogen is ventilated outside the building.

The impact of the events in this scenario is low due to existing prevention measures and the very short time that the hydrogen cloud is in detonable conditions.

The consequences of such hydrogen (deuterium) leaks can be significant if the detonation occurs, causing significant damage inside the CTRF building.

Scenario N.38 Explosion of an oxygen cylinder.

PHA analysis and consequence modeling show that the explosion of a cylinder at the CTRF storage of oxygen cylinders can have major consequences in the immediate vicinity of the explosion source with a possible domino effect on other cylinders in the depot, by the effect of overpressure or projectiles formed in explosion.

The causes of the accident may be defective construction materials or external fires at other installations. The impact of such scenarios is low due to existing storage and handling measures of the cylinders.

Modeling performed - rupture of gas tanks such as oxygen.

For the significant scenarios identified, following the risk analysis, the following conclusions can be drawn [18]:

The scenarios presented above can only produce reversible effects outside the site, over short distances in its North-East area.

It is noted that the scenarios were analyzed only from the perspective of the consequences of overpressure or thermal radiation.

Modeling for CTRF explosion scenarios shows that in the worst case scenario (spill of the maximum amount in column CD1) the effects of hydrogen detonation can severely affect the CTRF building but cannot have domino effects on other on-site installations.

8.2 Nuclear safety analysis **

The protection of the population, personnel and the environment is the main safety objective pursued since the initiation of the design of a nuclear installation, which is maintained in the stages of operation and decommissioning.

From the design phase, a rigorous hazards assesment *PHA was performed - by individual consideration of each system in the CTRF component. Additionally, representative potential accident initiating events have been identified / established based on existing documentation from other similar facilities, such as the Wolsong Tritium Removal Facility (WTRF) considered in the authorization documentation: CTRF Hydrogen Detonation Frequency Assessment and CTRF Licensing Basis Document (LBD)[1].

*** According to the definition in Law 111/1996, the term Nuclear Safety is defined as the set of technical and organizational measures designed to ensure the safe operation of nuclear installations, to prevent and limit their deterioration and to ensure the protection of professionally employed personnel, of the population, the environment and property, plant and equipment against radiation or radioactive contamination.*

8.2.1 Nuclear safety analysis for anticipated operational events

The two main hazards defined by the CTRF authorization documentation are [1]:

- Radiological hazard, due to potential releases of tritium, in the gaseous form DT or T2 and / or in the form of tritiated water vapor (DTO);
- Explosion hazard due to potential hydrogen release (including all isotopes: protium, deuterium and tritium in gaseous form).

All PHA conclusions and recommendations have been carefully considered by the designer so that the plant can operate safely.

The identification of the postulated initiation events was carried out systematically, based on the evaluation of the conceptual design, taking into account all plausible failures or malfunctions of components and systems, including those due to human error, as well as internal initiation events including common cause, as well as external events, both natural and human-induced [1].

8.2.2 Nuclear safety analysis for accident situations

In accordance with the requirements of the CTRF Licensing Basis Document (LBD) similar initiation events or similar consequences were grouped and classified according to frequency of

occurrence, and for events (including combinations thereof) with those more severe potential consequences for the performance of nuclear safety functions. Accident analysis were performed to demonstrate the dose criteria for the population established by CNCAN regulations applicable to nuclear installations .

Regarding the exposure of the population in accident situations at CTRF, the safety analysis took into account two possible scenarios, namely the massive emission of tritium gas or tritium in the form of tritiated water vapor, respectively, explosion due to the release of hydrogen (tritium). The analysis included the selection of a representative set of events (see Table 5.5.1), ranging from heavy water leaks, prompt detection, to severe events with full tritium gas emissions and partial heavy water inventory of CTRF release, and the break of a tritium getter. The evaluation of the results was done by classifying the analyzed events in the classification system of NSN-24 [107] for the dose criteria and the analysis of the basic project events for nuclear installations, presented in table 8.2.2.1.

Table 8.2.2.1 Dose criteria for analysis of project base events for nuclear installations

Class of events	Event category		Estimated annual frequency of occurrence of an event or sequence of events	Maximum actual dose value for the most exposed person outside the exclusion zone, calculated 30 days after the start of the emission, for all expected exposure routes
Class 1	Anticipated events in operation	Project-based events	$f > 1E-2$	0,5 mSv
Class 2	Accidents base project		$1E-2 > f > 1E-5$	20 mSv
Class 3	Conditions for the extension of type A design bases	Conditions for extending the design bases; they represent a subset of events outside the design bases.		
Class 4	Conditions for the extension of type B design bases			

It has been shown that, in the light of the modeling carried out, the maximum exposure is not at the limits of the NPP site but at a distance of 2000 m from the CTRF location. The highest exposure for a person in the population is evaluated, according to the analysis performed [95], in the case of an event with the failure of a cryogenic distillation column and the cold enclosure, an event framed with a frequency of occurrence between 10^{-2} and 10^{-5} , for which, in the conditions of a stack release of 6 PBq of tritium, an effective dose of 0.45 mSv is estimated. This value is significantly lower than the dose criterion set out in NSN-24, for design base events, according to which the maximum effective dose value for the most exposed person outside the exclusion zone must be less than 20 mSv [111]. Furthermore, it can be seen that in the event of an accident at CTRF, the effective dose for one person in the population is less than half the dose constraint for exposure of the population as a result of authorized practices. It is also shown that in an accident situation at CTRF, the actual doses for the population on the territory of Bulgaria are lower than 0.47 microSv (for the most severe event considered in the analysis), given that the average value of the effective dose due to exposure to the natural background of radiation is 2.4

milliSv / year [112], i.e. 6.7 microSv/ day. Thus, as a result of a very severe CTRF accident, a person in Bulgaria cannot receive a dose higher than 0.02% of the annual dose, which means less than 7.2% of the actual daily dose due to exposure to the natural background radiation. Similar, it is shown that the maximum dose value for a person in the population on the territory of Ukraine (located at a distance of at least 100 km from the CTRF location) is 7.8 nanoSv, which corresponds to a fraction of 0.12% of the daily effective dose due to exposure to the natural background of radiation.

Thus, it is concluded that an accident at the CTRF installation will not have radiological consequences on the population of the neighboring countries [95].

8.2.3 Measures to prevent or mitigate significant adverse effects

The analysis carried out in the design phase show that the technical design of the CTRF implements important measures that ensure an adequate level of protection of the personnel, the population and the environment. [1].

With regard to ensuring nuclear safety, respectively avoiding and limiting the consequences of radiological events, the CTRF project will provide for the passive and active protection measures necessary for the control of potential contamination, as follows [1]:

- a secondary barrier for equipment such as: double walls for tritiated heavy water transfer pipes from Unit 1/2 to the CTRF building;
- use of gloveboxes for local leakage containment and cold box from cryogenic distillation columns;
- atmospheric tritium removal system (ADS) which recovers tritiated heavy water vapor from heavy water leaks;
- installation of devices for collecting possible heavy water discharges, which are positioned to collect and retain tritium leaks;
- contamination control, e.g. by keeping tritium concentrations in the air in accessible areas below 0.4 MBq / m³;
- a radiological zoning of the CTRF building: the spaces inside and on the CTRF site will be zoned according to the specific criteria established by CNCAN (Art. 93-99 of the Norms regarding the basic requirements of radiological safety, CNCAN) and NPP procedures (RD-01364-RP009);
- equipment for radiological protection of staff;
- important measures to avoid and limit incidents, such as proper design of sewerage systems, active drainage, ventilation systems (HVAC system), dispersion system (gaseous effluent discharge stack), tritium retention or recovery systems closed circuit (ADS atmosphere detritiation system and TRS tritium retention system);
- measures to limit the total inventory of tritium that may exist in the installation;
- the inclusion of a secondary isolation system to prevent DT from entering the occupied area in the event of a breach in the primary isolation. Secondary insulation is frequently used in facilities for tritium removal or handling of tritium, especially for systems containing deuterium gas with high concentrations of Tritium.

The technical and nuclear safety measures implemented in the technical project that ensure the prevention and limitation of consequences for potential accidents shall take into account the capacity of the project to deal with severe external events, in accordance with the requirements of the authorization and international recommendations following the accident in Fukushima Japan. Radiation protection is also ensured by specific administrative measures, which include: training staff on technical and safety issues in the CTRF project related to the use of tritium, and establishing the individual staff dosimetry system [1].

The owner of the CTRF project, Cernavodă NPP, has an existing Radiation Protection Regulation and subsequent procedures applicable in operational activities, which provide for actions and measures to ensure radiation protection. The regulation is regularly reviewed, and actions and procedures are tested through simulation exercises. The procedural system will be reviewed and supplemented with specific aspects of the CTRF and will also be applied to the safe operation of

the facility for staff and the environment [1]. Additionally, the general management system of NPP includes the process of health and safety at work, the process of fire safety and the planning process for emergency situations - Site Emergency Plan which include the organizational structure with the roles and responsibilities of staff, identification and assessment of major hazards, operational control, emergency planning, emergency response procedures and processes [18].

8.2.4 Emergency planning and preparedness

Emergency situations for CTRF may result from radiological, chemical, fire, internal events, external events, etc. and will be treated integrated in the Internal Emergency Plan for the location of SNN SA - Cernavodă NPP, 2018 Edition, Revision 2 2021, prepared according to the MIA Order 156/2017 („Planul de Urgență Internă pentru amplasamentul SNN SA – CNE Cernavodă, Editia 2018, Revizia 2 2021, întocmit conform Ordinului MAI 156/2017”). It includes how to respond to the risk scenarios identified in the SEVESO Report. This contingency plan has been revised in 2021, including the manner of action for CTRF.

The Emergency Plan ensures [18]:

- organizing the process of planning and preparing for emergencies;
- on-site emergency plan and procedures;
- providing the material base and logistical support in emergency situations;
- emergency training and drills;
- interface with public authorities and informing the public.

Both the staff of Cernavodă NPP and the contracting staff working on the site of Cernavodă NPP are trained on how to respond and behave in case of incidents or accidents, including conventional ones.

Fire and explosion protection barriers are provided for the CTRF installation, through preventive measures such as optimizing the capacity of the installation - limiting as much as possible the volume of hydrogen in the installation, installation of detection and alarm equipment, ensuring ventilation in areas with potential hydrogen release, use of antiexplosion components in areas with potential hydrogen release, the use of hydrogen-impermeable materials, respectively by measures to limit the effects, such as a sidewall on the side of the site, the installation of expansion vessels, the provision of specific procedures. Relevant training of operating and response personnel is also considered [18].

On the site of Cernavodă NPP there is a PSI facility (PSI - prevention and fire extinguishing) with adequate equipment and machinery for rapid intervention in case of fire, with a permanent program organized in shifts, which serves all the buildings and systems on site. Periodically, emergency response drills are organized in accordance with the internal procedures and regulations in force, which also include fire response sequences [18].

The emergency plan on the Cernavodă NPP site provides the response in the situations that accidentally appeared on the Cernavodă NPP site that may have the following effects [1, 108]:

- affecting the health of the population in the vicinity of the site;
- short-term or long-term damage to the environment;
- affecting the health of the staff on site;
- damage to plant equipment and goods.

In order to prepare the staff, to test the procedures and the emergency plan, to test the response capacity of the Public Authorities and the Cernavodă NPP, the following types of emergency exercises are performed on the Cernavodă NPP platform [1]:

- Partial Exercise;
- Annual Exercise;
- General Exercise.

The evaluation of the installation condition where the event happened / of the systems / of the personnel and of the dangers generated by the event, respectively the classification of the

emergency situations depending of the event are made in a procedural way and immediately after the event [1].

8.3 Risks associated with the CTRF project

This subchapter covers the risks associated with the CTRF project, taking into account external and internal factors, namely:

- The potential of the project to provoke major events; and/or
- Vulnerability of the project to major events.

Potential of the project to cause major events

8.3.1 Risks associated with hazardous materials handling operations

For the installations / parts of the installations on the site, where dangerous substances are present in quantities less than 2% compared to the quantities relevant for the classification of the sites (according to Law 59/2016, annex 1, col. 2) the "hazard substance criterion" (one or more dangerous substances, classified according to Law 56/2016, which may be present or which may be produced uncontrolled, following some processes) was taken into account. According to this criterion, leakage of hazardous substances (diesel, hydrogen gas stored in tanks and cylinders, deuterium and tritium from the tritium removal facility) as well as emissions of vapors from:

- leaks in pumps, flanges, valves, connections or other fittings;
- cracks due to mechanical stress: pump damage, vibration, shrinkage caused by temperature differences, corrosion and / or abrasion, material defects or improper maintenance, or earthquake, strong wind;
- uncontrolled movement of the unloaded tanker due to human error;
- human errors in coupling of unloading tankers.

Accidental leakage of volatile liquids and highly toxic fumes can cause toxic dispersion.

Prevention measures and how to respond to the risks associated with the project

Due to the existing protection measures, the risk of personal injury is low.

The use of protective equipment and the training of personnel regarding awareness of the danger of serious injury to which they are exposed reduces the risk of such accidents [18].

8.3.2 Risks associated with fires and explosions

The risks associated with fires and explosions on the CTRF site were analyzed in the SEVESO Report, among which we list the following:

Fires

Fires may occur on the CTRF site, in equipment such as flammable gas tanks and cylinders (hydrogen, nitrogen), tankers containing flammable hazardous substances (diesel), and ignition of leaks or vapors resulting from leaks of liquids with high flammability and volatility (oxygen). Fires can also result in explosions by igniting flammable substances released by the explosion.

In the event of accidental spillage of liquids with high volatility and flammability, a vapor dispersion will occur as a result of evaporation of the spill into the atmosphere. Flammable vapor clouds may form in this way to form explosive atmospheres if the vapor concentration in the cloud is higher than the lower flammability limit (explosion).

Ignition of a flammable substance can be achieved if the temperature is higher than the combustion temperature (point) * of that substance or, below combustion temperatures, if the energy of the ignition source is strong enough to cause the substance to heat up and start a fire locally.

Potential sources of ignition may be [18]:

- short circuits in electrical installations due to damage or malfunction;
- mechanical, electrical or electrostatic sparks. Although sparks have very low energy, they can ignite highly flammable and less flammable substances at high temperatures;

- Atmospheric electric discharges (lightning) may cause flammable vapors to ignite, with the transmission of fire inside the equipment and / or may cause heating of the metallic parts of the equipment struck by lightning, with the ignition of flammable substances with which they come into contact;
- unauthorized open fire or without sufficient removal of the flammable environment from the work area and / or inadequate means of protection, for maintenance and maintenance work involving the use of open fire;
- arson actions;
- the transmission of fire from firebreaks of combustible elements present in the vicinity of installations such as diesel tanks or fires of equipment / components containing combustible parts;
- transmission of fire from electric power motors that drive pumps and / or ventilators in the event of a fire;
- transmission of fire from sources outside the site.

Fires can generally occur outside the equipment by igniting flammable substances. Inside equipment, fires may occur only where the air required for combustion is present, such as tanks and other storage vessels as well as tankers for flammable liquid raw materials. Fires inside the equipment are often explosive and in the case of tanks lead to the "blowout of the lid", the explosion being followed by a violent fire on the free surface of the tank. Widespread fires over the entire surface of large tanks are difficult to extinguish due to the large combustion surface and the difficulty of putting foam over the entire surface at the same time. In time, if the fire inside the tank is not controlled, exposure to fire can damage the tank cover, with the empty part of the cover (the upper part of the tank without liquid) having a tendency of "falling inside" due to heating. This can leave areas where the foam used for extinguishing is difficult to reach and which can later become sources of fire. Exposure to fire can also lead to cracking of the tank cover, with flammable substance leaking into the retention tank. Due to the relatively low capacity of the tanks, their technical sealing (with breather valves and flame stoppers), the risk of ignition inside the tanks is very low.

Fires are dangerous due to the thermal radiation they cause, air pollution with burn gases and smoke, as well as pollution from the debris resulting from the fire.

Thermal radiation can cause serious injury to operating and response personnel as well as damage to machinery and equipment, caused by exposure to fire and high temperatures, with the magnification of the accident by extending the burned area and causing explosions.

Smoke and burn gases can cause poisoning of operating or intervention personnel caught in the fire area without adequate protective equipment, this phenomenon being more serious in closed rooms where the possibilities of evacuation of the smoke and burn gas are lower.

Fire debris, mainly contaminated water resulting from large amounts of fire extinguishing, can pollute soil and groundwater if it reaches unprotected areas. Also, due to the large amounts of contaminated water that can result from the extinguishing action, the collection and then decontamination can create difficulties. At the site, due to the protection of exposed areas by concreting, the system for collecting and treating potentially radioactively contaminated water of Cernavodă NPP, the risk of pollution with potentially radioactively contaminated water resulting from a possible fire is very low [18].

Explosions

Due to the nature of the substances present in the on-site installations, explosions may occur by the formation and ignition of explosive flammable gas / vapor mixtures - air.

Hydrogen, present in installations, can be very susceptible to the formation of explosive atmospheres, being an extremely flammable and highly reactive gas, especially in contact with oxygen. The formation of explosive mixtures is possible by the vaporization of accidental spills of highly volatile liquids, even inside tanks and other storage vessels as well as tankers, where flammable vapors and air are present above the surface of the liquid.

Explosive atmospheres are formed when the concentration of flammable vapors in the air is within the explosion limits (lower explosion limit - LEL and upper explosion limit - UEL). In reality, explosions can also occur if the vapor concentration is outside the explosion limits, due to turbulence and unevenness in the explosive cloud.

The ability of flammable liquids to form explosive atmospheres depends on their nature and volatility. The more volatile a liquid is, the greater the amount of vapor that will form. Contact with a fire source or spark may result in VCE ("vapor cloud explosion"). These explosions are chemical explosions caused by the high-speed combustion of components and the transformation of some of the resulting energy into a pressure wave. Depending on the burning speed can occur:

- detonations - high intensity explosions (when the burning speed is high);
- deflagrations - explosions of low intensity (when the burning rate is low).

In the event of an explosion, serious damage may be caused to operating or response personnel caught by the blast and the associated thermal radiation. Significant damage to equipment and installations can also occur. The explosion could be followed by a violent fire of flammable substances released as a result of damage to the facilities.

The main feature of the explosion is the overpressure in the front of the shock wave - the blast. The power of the explosion depends on:

- the nature and amount of the substance in the explosive cloud. The nature of the substance in the explosive cloud influences the burning rate through its physico-chemical characteristics and the quantity determines the size of the explosive cloud;
- the configuration of the space inside the cloud. The more crowded the space, the smaller the distances between machines and equipment and the existence of walls that limit the dispersion: closed spaces or with side walls and / or roofs, the greater the power of the explosion. A certain degree of space constraint is therefore necessary to create the conditions for a relatively strong explosion. In on-site installations, the conditions for a relatively strong explosion may exist, in terms of spatial configuration, inside tanks and other storage vessels, in tankers, as well as in technological installations located in closed rooms. In open spaces, where there are no elements that favor the accumulation of vapors, explosive atmospheres can only form locally, in this case, due to the lack of space constraint, low-intensity explosions, accompanied by flash fires. In the case of low power explosions (low intensity explosions), the effect produced by the thermal radiation of the fire accompanying the explosion (Flash fire) is more significant than the blast (it manifests itself at a distance and has greater effects).
- ignition source. Powerful sources of ignition that increase the power of the explosion are explosions detonated by explosive devices (explosive charges) and previous explosions produced by a low energy source ignition, such as an explosion inside a room triggered by a previous explosion outside the building (eg, the explosion of accidental accumulations of flammable vapors or gases in buildings, triggered by a low-intensity explosion outside the room). The reverse phenomenon of starting an explosion outside the building from an explosion inside it is also possible.

In the case of the proposed CTRF development, the risk of explosive atmospheres in the event of accidental hydrogen leakage inside the building should be considered, with a significant amount of hydrogen (deuterium and tritium) in the system [18].

Prevention measures and how to respond to the risks associated with the project

Any overpressure in the cryogenic distillation system (CDS) is directed to the tanks to avoid the release of tritium. Overpressure from other systems is discharged directly to the stack. Since the hydrogen zone is a room in the CTRF building, starting from the basement and ending with the elevation +121 m, where +100 represents the CTA elevation, any deuterium / tritium (DT) release together with tritiated vapors are directed by the stack ventilation system.

The CTRF building is divided into an area of technological facilities (hydrogen area) containing all the primary processing equipment, an area of auxiliary systems (area without hydrogen), electric battery room, operating personnel room, helium compressor room and air compressors

room. The area of the technological installations is designed with an efficient ventilation, able to dilute the hydrogen emissions by aspirating the air from the room in the respective area.

The hydrogen monitoring system works continuously in the hydrogen area and in the battery room. The system generates audible and optical alarms when the hydrogen levels reach 20% of the lower explosion limit (LEL), thus warning the operating personnel, who will follow the intervention procedures from the NPP Emergency Plans, including CTRF-specific response procedures.

The automatic shut-off process is initiated if the hydrogen level reaches 40% LEL in the hydrogen zone. The total time for detection, data summary, transmission, display and alarm is less than 10 seconds to ensure prompt intervention.

All tritium-containing equipment is located inside the CTRF building, except for tritium low concentration expansion tanks located outside. Exhaust flows are designed to ensure efficient evacuation of hydrogen from the building through a 50 m stack, to prevent the accumulation of hydrogen in the enclosure and to avoid the risk of explosion.

When a hydrogen leak is detected, the system isolation valves will close to keep the main inventory. Isolation valves are designed to operate safely in the event of a single malfunction or hydrogen / tritium being detected in the air.

Fire and explosion protection barriers are provided [18].

The existence of a PSI facility equipped with adequate equipment and machinery for rapid response in case of fire, with a permanent program organized in shifts, which will serve CTRF [18].

Good sealing of installations (without leakage of flammable liquids or vapors), lack of ignition potential sources, including installations zone partitions and prohibition of the ignition or sparks sources presence in these areas, use of tools and equipment appropriate to the areas and application of an inert Nitrogen layer on the flammable product tanks reduces the risk of fire / explosion.

Due to the specificity of the existing installations on site, only relatively small leaks of flammable liquids or vapors can occur. For this reason, it can be appreciated that the risk of the formation of explosive atmospheres is only local in the area where the leak occurred and, in the area, where a possible leak would reach.

8.3.3 Risks associated to failure

The CTRF installation is equipped with a system for monitoring the operational parameters, on the entire technological flow to which are added the systems of automatic shutdown of the installation, in case of detection of possible failures [1]. Thus, the level of risk associated with failure to LPCE and CD1 pipelines and hydrogen leakage is considered low.

Vulnerability of the project to major events

8.3.4 Risks associated with natural disasters

The assessment of the risks associated with natural disasters is based on the identification of potential natural disasters characteristic of the Cernavodă NPP site, presented in the SEVESO report and the Nuclear Safety Report.

Earthquake

Seismic activity can cause soil disturbances and damage the foundations of the CTRF building, damaging process equipment, with possible insulation losses.

The intensity of the movement in the Cernavodă NPP area is influenced by the crustal and subcrustal seismic activity of the Vrancea area, of the Galati-Tulcea, Intra-Moesica, Sabla, Dulovo faults and of the area adjacent to the site. In order to determine the seismic sources, updated catalogs of crustal and subcrustal earthquakes were made.

The predominant source for the Cernavodă site is Vrancea Subcrustal. Using the attenuation ratios for the depth of 130 km, the deterministic magnitude of 7.5 and the median epicenter distance of 191.5 km, results in a maximum acceleration of 0.17 g at the ground surface. Corresponding to the bedrock is 0.11 g. For the maximum magnitude recorded 7.8, the maximum acceleration at the surface of the bedrock is 0.18 g. Seismic hazard studies associate this value with an annual probability of being exceeded between 1×10^{-2} and 1×10^{-3} .

However, for CTRF engineering, earthquakes with lower annual probabilities of occurrence, i.e. 10^{-4} , are considered, resulting in a determined acceleration of 0.3g at the bedrock level, acceleration at which the components with nuclear safety function of CTRF qualify for earthquake (DBE- earthquake project base). [1104].

In addition, seismic margin assessment is performed to ensure the nuclear safety of the facility and to identify the vulnerabilities of the facility to earthquakes exceeding the design basis level (DBE). These assessments consider possible earthquakes with a frequency of 10^{-5} /year.

Prevention measures and how to respond to the risks associated with the project

- Foundations of main and auxiliary structures shall be designed in accordance with the requirements of seismic and earthquake activity standards, including the applicable Eurocodes.
- Incorporation of seismic activity detection systems into main and auxiliary structures (where applicable).
- The structure of the CTRF building is seismically qualified (DBE), consisting of a reinforced concrete substructure, and a superstructure made of steel frames arranged on 5 levels, the maximum structural elevation being considered by the final floor and elevation +121. In addition, seismically qualified equipment will be used.
- Above-ground tritiated water transfer lines are under pressure, but are seismically DBE (design basis earthquake) qualified. In addition, these above-ground transfer lines will be built on seismically qualified concrete structures.
- The seismic activity is continuously monitored on the NPP site, by a system administered by the National Institute for Earth Physics, with sensors located within a radius of 40 km from the NPP. A system capable of recording strong seismic response signals of local components and structures has been installed.
- The ventilation system is supported by seismically qualified power supply systems.
- The hydrogen monitoring system is seismically qualified as DBE and is designed to operate for up to 72 hours on Class III emergency power supplies or up to 8 hours on Class II power supplies only, which are also seismically qualified.
- The isolation valves of the main process system are seismically qualified (DBE).
- The hydrogen zone ventilation system and its emergency power supplies are seismically qualified to ensure that they remain fully functional and capable of performing their safety function following a seismic event up to the DBE level. They will operate powered from a seismically qualified continuous power supply system which can operate for one hour after the loss of mains generators and / or even Diesel groups - backup generator (these being seismically qualified DBE), after which the installation is safely placed in a shut down status, safely, through a dedicated system.

Floods

The main effect of heavy and long-lasting precipitations may be flooding the site and loading of horizontal platforms or roofs. The coincidence of heavy precipitations with high surface water levels was reconsidered in the assessment of safety reserves. The three-dimensional modeling of the site and the conservative assumptions of breaking the protection dams allowed the possible assessment of the possible levels for heavy rains with low probabilities of occurrence.

Prevention measures and how to respond to the risks associated with the project

The project is to be connected to the surface water drainage infrastructure at Cernavodă NPP. The design base of the NPP boiler is $97.2 \text{ l} / \text{m}^2 / \text{h}$ (the design base of the drainage system - this magnitude of precipitation can be eliminated by the drainage system without causing water accumulation), and the level of protection is > 10 times the design basis: $97.2 \text{ l} / \text{m}^2 / \text{h}$ (the

maximum increase in water height on the platform is about 20 cm, less than 30 cm, which is the height of the ground floor of the buildings).

Landslides

The project is not located in an area considered to be at risk of landslides, as the gentle landforms in the vicinity of the CTRF site and the presence of vegetation on the slopes do not allow landslides.

Prevention measures and how to respond to the risks associated with the project

No risk associated with landslides has been identified, as the area is not prone to such phenomena. However, as a conservative passive protective measure, it has been foreseen to embank the slope towards Saligny hill.

Extreme weather events

Strong wind (Blizzard)

The updated data regarding the wind characteristics show that the absolute maximum speeds recorded at the three weather stations are: at Cernavodă 30 m / s, at Fetești 34 m / s and at Medgidia 34 m / s. From the statistical data processing it results that in the area of influence the wind speed can reach the value of 174 km / h for a return period of 100 years [25].

Prevention measures and how to respond to the risks associated with the project

At Cernavodă NPP, the structures without special safety requirements are designed respecting as a minimum the provisions for civil constructions STAS 10101 / 20-78 so as to withstand loads of 140 kgf / m² (1.37kPa) that would correspond to the direct pressure exerted by the wind with speed of 166 km / h. Design reserves and qualifications for other types and combinations of loads of nuclear structures offer intrinsic and increased resistance to strong winds.

Administrative measures are also provided for in the contingency plan to deal with cases where the wind may pose a threat to the operation of the plant or the safety of personnel [15].

Tornadoes and tornado-carried projectiles

In the region where the Cernavodă NPP is located, several tornadoes classified F0-F1 were registered on the Fujita scale, the strongest being classified F3. The spatial distribution of tornadoes in Romania shows that they are more common in the eastern part of the country, with a maximum located in the southeast of about 2 tornadoes on an area of 105 km² in 5 years [25]. The few data available do not allow us to address the tornado-induced hazard with a degree of uncertainty low enough to make a probabilistic assessment and determine the frequency of on-site production.

Prevention measures and how to respond to the risks associated with the project

The safety reserves assessment for this hazard, including projectile generation, has conservatively considered the damaging of diesel generators. The mitigation measures provide for the supply of mobile diesel generators by Cernavodă NPP. CTRF does not need cooling water when shuted-down, so it is not necessary to supply it in case of emergency.

Hail

The recurrence of the phenomenon is estimated at about 2 events per year, the maximum recorded in Cernavodă being 6 events per year. The average duration of the hail episode, calculated from the available data for the period 2001-2017 at Cernavodă station is 14 minutes, the maximum value is 60 minutes and the minimum is 2 minutes [25].

Prevention measures and how to respond to the risks associated with the project

From the point of view of nuclear safety, the estimated effect is the loss of connection to the national electricity grid. The event is considered in the design bases and accident analysis, there are specific procedures to address the abnormal situation occurred by using the Diesel-backup generator sets.

Lightning

The phenomenon can occur on site, especially affecting electrical equipment, but can also cause local effects or fire starts. Electric discharges were considered in the protection of CTRF structures. Events with extensive consequences generated by electric discharges are considered to be loss of power supply on site or loss of connection to the national grid.

Prevention measures and how to respond to the risks associated with the project

The system of protection against electric shock is intended to reduce the risk of damage to buildings and outdoor technological installations and the risk of personal injury.

The lightning protection system consists of a capture installation, earthing sockets (common for lightning protection and electrical protection installation).

8.4 Description of prevention measures and response to accidents and adverse events

Cernavodă NPP has implemented a concept of deep defense system, which includes technical and procedural barriers prevent and mitigate the accidents effects and emergency response, taking into account initiation events involving equipment failure and human interaction, but also credible severe external conditions (earthquakes, floods, bad weather, etc.), which may affect the operation of the plant.

This concept is integrated in the Management System of Cernavodă NPP and will be applied to the tritium removal installation, by including the CTRF specific security procedures in the risk management procedure and in the Emergency Response Plan of the plant. The management system of Cernavodă NPP is subject to the authorization process according to the requirements of Law 111/1996 on the safe conduct, regulation, authorization and control of nuclear activities, with subsequent amendments and completions.

At the current stage of the project, the general requirements are set out in the Design Requirements for some of the emergency response systems, such as fire extinguishers.

Thus, the requirements for CTRF are to connect to the fire-extinguishing water distribution network of Cernavodă NPP. Outdoor and indoor hydrants will be installed on this network, which will ensure the estimated flow required to extinguish the fires. In addition, an H-CTRF fire hydrant is placed on the outside pipe. In the event of an external fire, fire extinguishers are provided by means of this new hydrant and those existing on the fire extinguishing water supply network [18].

As the CTRF will be carried out on the site of the Cernavodă NPP, the CTRF **Emergency Plan** will be an integral part of the **Cernavodă NPP Emergency Plans** [113] and will include the response in the event of an accident for the CTRF. The personnel of the tritium removal installation will be trained in accordance with the specific provisions of the installation and those of the Cernavodă NPP.

9. NON-TECHNICAL SUMMARY

Project description

Cernavodă NPP is located in Constanța County, in southeastern Romania, about 2 km southeast of Cernavodă. Nuclearelectrica SA operates two units in Cernavodă, U1 and U2, through its Cernavodă NPP branch. Unit 1 was commissioned in 1996 and Unit 2 in 2007.

Unit 1 and Unit 2 of Cernavodă NPP use CANDU-6 (Canadian Deuterium Uranium) technology, designed by Atomic Energy of Canada Ltd. The CANDU-6 reactor is a pressurized heavy water reactor. Heavy water (D₂O) is used in nuclear systems as a moderator and primary heat transfer agent (coolant).

Tritium is generated as a by-product of the nuclear process in the reactor as a result of the interaction of neutrons with heavy water in the moderator circuit and heavy water in the primary heat transfer circuit. The heavy water from the two systems is used to reduce the energy of the neutrons produced in the fission reactions in order to be used efficiently and maintain the fission reaction (neutron moderation), i.e. to take over and transport the heat from the reactor active zone to the turbine-generator.

Tritium accumulates over time in systems using heavy water (coolant and moderator), resulting in tritiated heavy water. The concentration of tritium in heavy water increases to an equilibrium level, reached when the rate of tritium production is compensated by its radioactive decay and technological losses. The equilibrium level is usually reached after two-thirds of a reactor's life cycle.

Long-term storage of large volumes of tritiated heavy water (around 1000 tonnes) at the end of a nuclear power plant's lifetime would require high resources and costs and presents a significant radiological risk to humans and the environment. Therefore, CTRF Project brings significant benefits in terms of radioactive waste management by extracting and containing tritium in safe storage, which also allows a potential future use (after decommissioning of the Cernavodă NPP) of a valuable heavy water resource.

CTRF planned to be implemented through this Project will take over alternatively and will ensure the Tritium removal from the heavy water used in the nuclear systems from the U1 and U2 reactors of Cernavodă NPP.

Along with the reduction of the tritium inventory in the moderator and primary heat transfer systems belonging to the two reactors, through the application of tritium removal process, it is expected to achieve a reduction in the doses received by Cernavodă NPP staff as a consequence of the reduction of tritium contamination levels generated by technological losses of tritiated heavy water from the active systems. A gradual reduction of tritium emissions to the environment in the form of radioactive effluents is also expected, in line with the reduction of tritium concentrations in the active systems of the plant.

The area inside the Cernavodă NPP, on which the CTRF project will be built, is located in the fixed front of the plant and is limited by the slope towards Saligny Hill and the main road inside the NPP - which allows access from the PCA1 gate to the Water Treatment Plant (STA).), Thermal Start-up Plant (CTP) and leads to DIDSR.

The implementation of the CTRF project involves completion of the following main stages: construction (construction and erection works), commissioning, operation (lifetime of 40 years), followed by decommissioning and subsequent site restoration.

The CTRF plant tritium removal method consists of separating tritium (T2) from the tritiated heavy water (DTO, deuterium tritium oxide) using liquid phase catalytic exchange (LPCE) processes and concentrating the tritium by cryogenic distillation (CD), followed by storing the tritium in a safe condition (as metal hydride). The process can be briefly described as follows:

- Transfer of tritium from heavy tritiated water (liquid state) to gaseous state;
- Separation of tritium from deuterium / collection by cryogenic distillation; and
- Safe storage of tritium as metal hydride.

The project also includes equipment for monitoring liquid and gaseous emissions, as well as fire prevention and control systems. The CTRF installation will be connected to the existing utilities of the Cernavodă NPP site (drinking water, sewerage / rainwater drainage and electricity).

The CTRF project will not consume significant amounts of materials and will not generate significant amounts of waste during the operation phase. The purchase and supply of consumables will be managed within the existing procurement system of Cernavodă NPP and all waste flows (radioactive and non-radioactive waste) will be managed in accordance with the existing waste management procedures of Cernavodă NPP. The waste management procedures are part of the Integrated Management System of Cernavodă NPP, which includes the requirements of ISO 17025 and ISO 27001. SMI of Cernavodă NPP also holds ISO 14001:2015, ISO 45001:2018, EU Environmental Management System and EMA Audit certificates.

Description of the alternatives

During the development of the CTRF project, 3 main alternatives were analyzed: "Zero" or "no action" alternative, on-site detritiation alternative (1st alternative) and off-site detritiation alternative (2nd alternative).

Consistent implementation of the ALARA (As Low As Reasonable Achievable) principle makes "Zero" Alternative unacceptable, because if a feasible technical solution to reduce the levels of tritium in the effluent produced by the plant, and consequently the exposure of staff and the population exists, it is necessary to reduce the current levels, even if they are below the regulated limits.

Implementation of any of the other 2 alternatives will have a positive impact on the environment, by reducing the levels of tritium concentration in the moderating system and in the primary heat transport system from the two NPP units. The immediate consequence will be a reduction in overall tritium emissions from the site and thus a reduction in the activity concentrations of this radionuclide in the affected environmental factors. However, the Off-site Tritium removal Alternative involves high construction costs, as the tritium removal facilities that can currently provide these services are located at great distances from the NPP (Korea, Canada). Moreover, international shipments of radioactive materials are difficult to authorize (high costs, long time), and during the transport accidental leaks of the tritiated heavy water can appear causing significant environmental damage.

Based on the above, the tritium removal on site Alternative was selected, with the CTRF being located in the perimeter of Cernavodă NPP.

From a technological point of view, three types of technological processes were analyzed, respectively:

- Solution 1 - Combined electrolysis and catalytic exchange – Cryogenic distillation (CECE-CD). The CECE-CD solution is based on the transfer of tritium from water to the gaseous phase by a combined electrolysis process – isotopic catalysed exchange (thus increasing the concentration of tritium in heavy water) followed by a final tritium concentration by cryogenic distillation and its safe storage (metal hydride).

- Solution 2 - Direct Electrolysis - Cryogenic Distillation (DE - CD). The DE-CD solution consists of tritium transfer to the gaseous phase by the electrolytic dissociation of the tritiated heavy water followed by a final tritium concentration through cryogenic distillation and its safe storage (metal hydride).

- Solution 3 - Liquid phase catalyzed isotope exchange- Cryogenic distillation (LPCE –CD). The LPCE-CD solution is based on the tritium transfer from water to gas phase through a catalysed isotope exchange process followed by a final tritium concentration through cryogenic distillation and its safe storage (metal hydride).

Selection of the technology to be implemented through the CTRF was based on the following considerations:

- the minimum risk for personnel and the environment, associated with the tritium extraction technology;
- the optimal dimensions of the main components in relation to the location of the installation,
- the necessary process subsystems and the appropriate size in terms of complexity, operability and maintenance;
- Minimal D₂O and tritium inventories and storage of tritium, operation and maintenance specific safety issues;
- utilities and optimal operating costs;
- authorization requirements for the technical solution;
- estimated cost of the investment;
- potential contractors for services and materials availability in Romania and operational requirements.

Decision was made to implement the technology based on LPCE - CD (Solution 3) developed at ICSI Rm. Vâlcea within the Pilot Installation and for which exist operational experience (OPEX) at the Wolsong tritium removal facility (WTRF) in Korea.

The location of the CTRF within NPP perimeter is at 200 m East of the U1 reactor, location option selected in order to reduce the risk for the nuclear safety systems, equipment and components of the nuclear units U1 and U2, by increasing the distance between them and CTRF.

Potential impact and preventive measures

The method and criteria for impact assessment used by the developer are in accordance with Order 269/2020 approving the general guidance for the stages of the environmental impact assessment procedure, the guidance for environmental impact assessment in a transboundary context and other specific guidance for different sectors and categories of projects.

The potential impact on environmental factors and on the human population was analyzed for the construction and operation stages of the CTRF project, taking into account measures to prevent and reduce potential significant effects.

The actual decommissioning will be carried out on the basis of a specific decommissioning project, integrated with the nuclear decommissioning project, following the environmental impact assessment procedure, which will establish the requirements of the authorities for the decommissioning of the CTRF, after obtaining all necessary approvals/agreements/authorisations. Thereby, the environmental impact assessment of the decommissioning phase of the installation is not addressed in this Report.

The cumulative impact is also analyzed, assessing the possible cumulative effects of the project with other projects planned to be built / put into operation in parallel with the CTRF, as well as the potential to produce a cross-border impact that may result from the projects construction and operation.

The management of materials within the natural resource factor will be done as judiciously and efficiently as possible so that the CTRF project is considered to be carried out in the spirit of sustainable development. Therefore, neither the construction nor the operation of the CTRF facility will have a significant impact in terms of the use of materials from the environmental factor of exhaustible natural resources.

Environmental factor - Water

The most common sources of pollution of the environmental factor water during the construction phase of the project are accidental pollution with hydrocarbons, other chemicals (paints, solvents), domestic wastewater from the contractor's staff and improper temporary storage of waste. The impact will be negligible, indirect, reversible, local and short term, through the application of the following administrative and technological protection measures, the environmental factor water:

- Avoidance/elimination of wastewater leaks during the execution works.
- The washing of the wheels of the means of transport when leaving the construction site compound will be carried out in the specially designated area.
- Use by staff of the existing sanitary facilities of the Cernavodă NPP and/or of the ecological toilets.
- Ensuring proper maintenance of the machinery used on site to prevent accidental spillage of lubricants and fuels.
- Storage and use of hazardous substances will be carried out in accordance with CNE Cernavodă procedures.
- Sorting and storage of waste will be done specially designed areas to avoid the dissolution and run-off in meteoric/pluvial waters.
- Repairs and maintenance work on machinery and vehicles (oil changes, greasing, etc.) will be carried out in authorised service units. Such work is prohibited on the site.
- At the start of the work and throughout the work, the staff involved in the work must be trained in the following aspects:
 - general environmental protection conditions;
 - waste management;

- how to act in the event of accidental pollution;
- maintenance of machinery;
- cleanliness at the worksite

In the **operational phase**, the input of domestic wastewater from the CTRF plant to be discharged into the existing domestic sewage network is very low given the number of staff that will be servicing the plant. Thus, the average input of 2.90 m³/day of domestic waste water to be added to the domestic waste water generated by the staff servicing the existing activities in U1 will not exceed the waste water carrying capacity of the existing networks. In view of these considerations, the impact will be negligible, indirect, reversible, local and short-term.

The radiological impact on the water environmental factor may be due to liquid effluent emissions under normal or accident conditions. Releases from the project during normal operation may be due to leakage from process systems within the facility or during planned operations (e.g. equipment maintenance). Releases of heavy tritiated water (DTO) may be caused by leaks at pipe and equipment joints and as a result of maintenance operations such as replacing a filter, valve or repairing a pump.

Tritium releases in the form of liquid effluents from units 1 and 2 of the Cernavodă NPP do not significantly affect the quality of surface waters in the area of influence of the plant. Also, the results of radioactivity monitoring of drinking water and deep groundwater in the area of the Cernavodă NPP site shows that they are free of radioactive contamination, which means that tritium releases from the plant have no impact on these waters. Liquid effluents from the CTRF will be managed under the same management system as those from the operation of the plant's two CANDU units. The level of tritium activity in the liquid effluent emitted from the CTRF is lower than in the effluent from the NPP and the radiological impact associated with it is consequently lower. The application of the measures foreseen in the effluent management programme of the NPP will allow the emissions to be kept under control, within the derived discharge limits, so that the radiological impact on the water environmental factor is kept as low as reasonably achievable. In view of these considerations the radiological impact on the water environmental factor associated with tritium emissions from the CTRF will be minor, directly cumulative, reversible, local and short term.

Through the application of the tritium removal process, it is expected that the tritium emissions in the liquid effluents from the Cernavodă NPP site will be gradually reduced, which will lead to a corresponding reduction of the radiological impact of the plant's activities on the water environmental factor. Thus, the radiological impact on the water environmental factor due to the operation of the CTRF, as an ALARA (As Low As Reasonable Achievable) measure to reduce tritium releases in the form of liquid effluents from Units 1 and 2, can be considered to be positive, direct, reversible, local and long-term.

Environmental factor - Air

During the **construction phase**, the potential impact on the air will be generated by emissions of dust, NO₂, and CO that come from construction activities and from the burning of fuels in the engines of road and plant vehicles. The impact will be negligible, direct, reversible, local and short-term, taking into account the following air protection measures:

- The transport of powdery materials shall be carried out using covered vehicles in order to avoid the generation of dust.
- Ensure an adequate level of moisture for disturbed land surfaces and temporarily stored piles of earth for fillers in order to limit dust emissions as much as possible.
- Washing paved surfaces regularly or whenever necessary.
- Limit the speed of travel for vehicles on the construction site so that the re-suspension of particles on unpaved or disturbed surfaces is kept to a minimum.
- Ensure proper maintenance of the equipment used on site so that the emissions from the combustion of fuels for their operation do not exceed the limits approved by the technical book.
- Ensuring proper maintenance of machinery used on site so that emissions from the combustion of fuels for their operation do not exceed the limits approved in the technical book.

- Efficient proper scheduling of transport activities so as to avoid overcrowding on site and unjustified maneuvers of machinery / vehicles.
- Execution only in favorable weather conditions of activities that involve a potential negative impact on the environment. Excavations, earthworks or fillings in high wind conditions will be prohibited.
- The engines of the machines will be stopped during the periods when they are not involved in the activity.
- Falling heights in material transfer activities, such as the discharge height of dust-generating materials (earth, aggregates), will be minimised.
- Efficient planning of transport/supply of materials/waste management to minimise greenhouse gas emissions.

During the construction phase of the project, no radioactive emissions will be generated.

During **operation phase**, most of the tritium activity released into the environment by the CTRF in normal operation is found in the gaseous effluent. The estimated annual tritium emissions from the CTRF are an order of magnitude lower than the annual emissions currently achieved by the two units of the plant. The monitoring results showed that, in terms of the operation of units 1 and 2, the gaseous emissions of tritium have a negligible impact on the quality of the environmental factor air. Considering the similarity of the exhaust systems (size of the ventilation stacks) used by Units 1 and 2 and the CTRF respectively, it can be estimated that the impact that the releases of gaseous, radioactive effluents from the CTRF will have on the air quality in the area of influence of the Cernavodă NPP will be minor, direct, local and reversible. The application of the CTRF process is expected to gradually reduce gaseous tritium emissions from Units 1 and 2 of the Cernavodă NPP, which will be reflected in reduced levels of tritium contamination of the air in the vicinity of the plant. Therefore, the cumulative radiological impact of the operation of the CTRF and Units 1 and 2 on air quality will be positive, direct, reversible, local and long-term.

Direct greenhouse gas emissions

In the **construction phase**, total greenhouse gas emissions include emissions from the transport of materials and waste to and from the construction site, and emissions from the use of heavy machinery and equipment during construction.

Emissions from the use of heavy machinery and equipment during construction will be closely related to the performance of the equipment and machinery to be used by the organisation responsible for the site activities. Emissions of pollutants decrease the more advanced is the performance of the engines, i.e. lower fuel consumption per unit of power and tighter emission control.

During the operation phase of the CTRF plant, insignificant greenhouse gas emissions will be generated, such as CO₂, CH₄, HFC, PFC, N₂O, SF₆.

Direct emissions of greenhouse gases such as NO_x and CO can only occur in the event of interruption of the electricity supply when the units diesel back-up generator are in operation or during their periodic testing- 2 hours/month/ Diesel group- backup generator.

The estimated direct greenhouse gas emissions generated by the 2 Diesel-reserve generator sets are a maximum of 395.03 tCO₂ / year.

Taking into account that the supporting activities, such as the operation for the periodic testing of the backup diesel-generator sets and the traffic in the site characterized by discontinuous, short duration and low value emissions, it is estimated that the normal operation of the CTRF plant will have a negligible, direct, reversible, local and short-term impact on the air quality on the platform and outside the Cernavodă NPP perimeter, applying the following air protection actions:

- Combining the transport activities necessary to supply the CTRF and waste management with those of units U1 and U2 so that emissions are minimised.

Environmental factor - Soil

During the **construction phase**, the potential impact on soil may be generated by accidental hydrocarbon leakage that could result from the operation of machinery/transport equipment used

during the construction period; repairs to such machinery/transport equipment in undesignated areas; and improper disposal of waste generated during the construction period. The impact will be negligible, direct, reversible, local and short term by applying the following soil protection actions.

- Establish travel routes for vehicles and construction equipment on paved access roads, and in situations where this is not possible, the speed will be reduced so that the disturbed ground surface is reduced to a minimum.
- Periodic inspections of machinery / vehicles to prevent / reduce the risk of accidental spillage of lubricants / fuels.
- Parking and emergency maintenance of vehicles / equipment will be performed only on concrete platforms. Repairs to machinery/vehicles will be carried out by authorised economic operators.
- Arrangement of appropriate spaces, equipped with suitable containers for the collection and temporary storage by category of waste generated during the execution period; the waste will be recovered / disposed of by authorized companies (according to the NPP procedures).
- It is forbidden to spill used oils, fuels, or untreated wastewater on the ground, and in case of accidental spills, absorbent materials will be used.
- Avoid direct placement of construction materials and waste resulting from the works on the ground.
- The storage and use of hazardous substances will be in accordance with NPP procedures.

No radioactive materials are used in the **construction phase** of the CTRF, so any soil contamination due to planned radioactive releases or accidental releases associated with the project is excluded. For this reason, radiological impact of the CTRF on the soil environmental factor for the construction phase of the facility is not discussed. Given that the construction works are carried out within the Cernavodă NPP site, which is a supervised area, according to the plant's internal procedures, all materials leaving the site (construction waste, excavated soil, etc.) will be subject to radiological monitoring to confirm the absence of radioactive contamination.

During the **operation phase**, the potential impact on the soil may be generated by accidental oil spills from the diesel fuel supply of the Diesel-backup generators.

Another potential source of contamination is also the improper handling and storage of non-radiological waste generated from CTRF activity. However, the implementation of protection and mitigation, administrative and technological measures, as well as CNE procedures prevent improper waste management.

The impact caused by the sources described above will be negligible, directly cumulative, reversible, local and short term, given the existing facilities and equipment and the conduct of activities in compliance with all applicable NPP procedures.

From a **radiological point of view**, the impact of the operation of the CTRF on the soil environmental factor is due to releases of tritium from the installation, in the form of liquid or gaseous effluents, under normal operating conditions or releases of tritium under accident conditions, which may generate, under certain conditions, radioactive soil contamination.

The results of radiological monitoring of soil in the vicinity of the Cernavodă NPP site showed that tritium is the only radionuclide present in the soil that can be associated with effluent emissions from the plant, but its concentration levels are very low. Thus, taking into account that the tritium emissions from the CTRF are estimated to be an order of magnitude lower than those from Units 1 and 2, it can be concluded that their effect on the tritium concentrations induced in the soil in the vicinity of the plant will be insignificant.

Assessments have shown that, under accident conditions at the CTRF, radioactive soil contamination is of a local nature and the actual doses that could be induced by airborne tritium concentrations subsequently generated by the presence of this soil contamination will be negligible. Under these circumstances, it can be stated that the environmental impact will be

limited to areas in the immediate vicinity of the installation and will be minor, local, reversible with short-term effects.

Biodiversity

During the construction phase the project will not impact on protected areas as they are at least 2.5 km away. Also, indirect impacts that could occur due to degradation of air and water quality will be avoided as a result of administrative and technological mitigation measures implemented by the Contractor. Impacts on flora and fauna will be neutral, as no species of conservation value are present in the vicinity of the CTRF facility.

Construction operations will take place mainly during the day. However, for short periods of time, construction activities will be carried out at night requiring artificial sources of lighting. These sources will be directed towards the perimeter of the CTRF and sized in intensity so as not to cause major disturbance to wildlife in the vicinity of the CTRF site. The impact will therefore be negligible, local, reversible, and short-term.

Degradation of aquatic and terrestrial habitat may be caused by decreasing air quality levels during the **operational phase** of the Project. Air quality is influenced by tritium emissions from the CTRF stack and exhaust emissions from the diesel-generator back-up units.

Emissions from stand-by diesel generator units as a result of diesel use are CO₂, SO₂ and NO_x. Simulation of emissions from the stand-by diesel-generator sets shows that the decrease in air quality generated by the project will have a negligible impact on aquatic and terrestrial habitats.

As studies to assess the impact of activities on the Cernavodă NPP platform on biodiversity have shown, the impact on flora and fauna in the habitats around the Cernavodă NPP due to the environmental releases of tritium from the two NPP units is negligible. As regards the impact due to radioactive emissions from the CTRF, since these are an order of magnitude smaller than those from the plant, it can be estimated that the impact of normal operation of the waste facility will be negligible. Also, considering the gradual reduction of tritium emissions from the two units as a result of the application of the heavy water detriment process, the cumulative radiological impact of the operation of the plant and the CTRF on biodiversity will be reduced in proportion to the reduction of emissions.

Climate and climate change

During the **construction phase**, the release of indirect greenhouse gas emissions due to waste management resulting from the implementation of the CTRF project will be negligible, as the waste generated will be predominantly inert and the emissions from the disposal of this waste will not generate significant quantities of greenhouse gases considering the duration of the construction phase.

During the **operational phase**, the ancillary activities generating greenhouse gases are the transport activities for the supply of the CTRF plant and for the disposal of the waste generated by it.

The small amount of waste produced by the 26 employees who will be working in shifts means that the operational phase can be described as a negligible greenhouse gas input.

The CTRF plant will be supplied with electricity from its own transformers at the Cernavodă NPP - nuclear power producer, so the amount of indirect greenhouse gas emissions will be insignificant.

Noise

During the **construction phase** of the CTRF facility the noise sources will be generated by heavy vehicle traffic, machinery operation and various tools/equipment. Noise level modelling has shown that the resulting noise level at 500 m from construction activities will not exceed 58 dB LAeq. There are no residential areas within 1 km of the site (exclusion zone) where the construction noise level will be 52 dB LAeq.

Therefore, the **construction phase** of the project will not generate a noise level higher than the noise level recorded for the nearest residential area and thus will have a negligible, local, short-term impact.

During the **construction phase**, the CTRF installation will lead to an increase in noise levels of less than 1 (one) decibel in the immediate vicinity of the Cernavodă NPP, and therefore there will be no exceedance of the limit values of the noise levels allowed for the industrial noise source (65 dB(A)). In conclusion, the impact generated by noise is negligible, locally, during the whole lifetime of the CTRF installation.

Socio-economic level

Up to 100 jobs are expected to be created during the **construction phase**. The construction employment plan will maximise opportunities for the local community as skills are available. Thus, the impact will be positive, direct, reversible, local and short term.

Approximately 26 jobs for technical staff will be created in the **operational phase**. Young people from local communities will be offered technical training opportunities to maximise the medium and long-term benefits. Thus, the impact will be positive, direct, reversible, local and long-term.

Human health

Assessment of the impact of normal operation of the tritium removal plant at the Cernavodă NPP on human health

The impact that the operation of the CTRF could have on the health status of the population in the vicinity of the plant site is the effects of exposure to low doses of ionising radiation due to the presence in the environmental factors of tritium from planned emissions associated with the operation of the tritium removal plant. On the basis of estimates made by the plant designer of the level of annual tritium emissions, the maximum effective doses attributable to a representative member of the population under normal operating conditions of the CTRF have been assessed. The risks of inducing stochastic effects on the health status of members of the population exposed to these dose levels have been estimated according to current scientific models and are at insignificant levels. However, if the cumulative impact of the operation of the CTRF and Units 1 and 2 of the Cernavodă NPP on the health status of the population is analysed, a reduction of the maximum effective doses to the population can be expected as a result of the gradual reduction of the total tritium emissions from the site due to the operation of the CTRF. This impact reduction effect was also highlighted by the study carried out by the National Institute of Public Health, on the assessment of the radiological impact on the health status of the population as a result of the operation of the CTRF, which concluded that: "normal operation of the tritium removal facility, according to the estimates of the technical documentation, to a reduction of potential diseases associated with tritium emissions in the environmental factors and, consequently, to a benefit for the health of the population residing in the area of influence of the Cernavodă NPP".

Assessment of the impact on human health in the event of an accident at the tritium removal facility at the Cernavodă NPP

From a radiological point of view, the risks associated with the occurrence of accidents with significant tritium emissions to the atmosphere have been assessed in the Kinectrics CTRF Accident Analysis Report for Public Dose (KI CTRF-00437 Rev 05). The KI CTRF-00437 Rev05 report contains the results of the estimation of doses to the general public as a result of events associated with tritium emissions from anticipated operational events and internal or external events with frequencies of occurrence in the range 10^{-2} - 10^{-7} events per year. Based on the results of this analysis, as well as an assessment presented in the Report, it was concluded that the radiological impact of an accident at the CTRF facility on the population and the environment in the immediate vicinity of the facility will be insignificant, directly cumulative, reversible and short-term.

Material goods

During the construction phase there is no possibility of an impact on underground heritage assets, as the nearest material assets of national importance in the Cernavodă area are located at approx. 2 km west of the construction area.

During the construction phase the CTRF will have no impact on above ground heritage assets, as all these assets are located at a distance of ca. 2-3 km north-west of the project. It will also

have no impact on the landscape as there are no registered landscape assets of landscape value on the site and in its immediate vicinity.

It is estimated that operations during the **operational phase** of the CTRF project will have no impact on above ground physical assets as all above ground heritage assets are located approx. 2-3 km in the north-west part of the project.

Thus, it can be concluded that the CTRF project will have no impact on material assets and cultural heritage.

Cross-border impact

The radiological safety analyses for accident situations at the CTRF show that the effective doses to members of the population on the territory of Bulgaria are lower than 0.47 microSv (for the most severe event considered in the analysis), while the average effective dose due to exposure to the natural radiation background is 2.4 milliSv/year, i.e. 6.7 microSv/day.

Thus, as a result of a severe accident at CTRF, a person in Bulgaria cannot receive a dose higher than 0.02% of the annual dose, which is less than 7.2% of the effective daily dose due to exposure to the natural background radiation. Similarly, it is indicated that the maximum dose to a person in the population of Ukraine or the Republic of Moldova (located at least 100 km from the CTRF site) is 7.8 nanoSv, which corresponds to a fraction of 0.12% of the effective daily dose due to exposure to the natural background radiation. Under these conditions, it can be stated that the radiological effects of an accident at the CTRF on the population of neighbouring countries are insignificant.

Cumulative impact

For the assessment of the cumulative impact during the construction phase of the CTRF project, the works that can be carried out in parallel, i.e. those related to the Intermediate Burning Fuel Storage (IBFS) project based on the phased construction of MACSTOR 200 modules, were taken into account.

The project for the Refurbishment of Unit 1 of the Cernavodă NPP and the Expansion of the Intermediate Burning Fuel Storage with MACSTOR 400 Modules is in the regulatory procedure from an environmental point of view. According to the information currently available on the project implementation schedule, it is estimated that the construction works will not take place simultaneously with the CTRF project.

During the construction period of the CTRF, the potential pathways of cumulative effects have been identified, i.e. dust emissions from soil excavation works and gas emissions from machinery and means of transport that will be used during the construction site organisation.

Taking into account the distance between these projects; the specific measures to prevent and limit the impact and the compliance with the requirements of the applicable Cernavodă NPP's permits/agreements/authorisations and procedures, it can be concluded that the impact produced by the CTRF-related works, when combined with that of the other works carried out on the NPP site, will be insignificant, locally and in the short term.

During the operation of the CTRF, potential pathways of cumulative impact were considered in the cumulative impact assessment, i.e. radioactive tritium emissions from the CTRF activity with those from the plant activity; non-radioactive emissions from the CTRF backup diesel-generator units with those from the existing activity; and liquid effluents generated from the CTRF activity in view of their management by the existing plant systems.

Taking into account the results of the monitoring of the Cernavodă NPP activity, the conclusions of the environmental impact assessment for the CTRF project and the contribution of the CTRF facility to the reduction of tritium emissions resulting from the operation of the two NPP units, it can be concluded that the impact produced by the operation of the CTRF facility cumulated with that of the other operating facilities on the NPP site (U1, U2 and DICA) and with those expected to become operational during the lifetime of the CTRF plant (U3 and U4, where the main buildings are largely completed, followed by completion works, equipment/facilities assembly) will be insignificant in the short term and positive in the medium and long term.

Monitoring actions

For the CTRF project, monitoring will be carried out by CNE Cernavodă. For the construction phase final monitoring programme will be established by the environmental agreement issued for the CTRF project.

With the implementation of the CTRF project, the environmental radioactivity monitoring programme will be updated to include locations and possibly monitoring methods specific to the new facility with potential impact on environmental factors. The environmental radioactivity monitoring programme will be carried out according to the procedures approved by CNCAN.

The radioactive effluent monitoring programme at Units 1 and 2 will be extended to include emissions from the CTRF. The maximum effective doses attributable to a representative member of the population will be estimated on the basis of tritium emissions from the CTRF, using calculation models similar to those applied for Units 1 and 2 of the Cernavodă NPP, which to be approved by CNCAN.

The NPP has also implemented a physico-chemical monitoring program of non-radioactive liquid effluents, applied for U1 and U2 in normal operation, in accordance with the Water Management Permit Modifying Permit No.58/07.2021, No.72 of 06.09.2021 for Cernavodă NPP U1 and U2.

For the decommissioning phase, the environmental impact assessment procedure will be carried out in accordance with the legislation in force at the time, through which the requirements of the authorities for monitoring environmental factors will be established.

Difficulties in processing data needed in forecasting and assessing effects

From a radiological impact point of view, the uncertainties in assessing and forecasting the environmental impact of the operation of the CTRF in combination with future on-site projects lie in the complexity of these nuclear activities and the uncertainties in the accuracy of the data until their technical solutions are approved.

Uncertainties about the precise details of the project and its environmental impact

The radiological environmental impact assessments following the implementation of the CTRF project have been carried out on the basis of data on the impact due to the operation of the plant, to date, by extrapolating these data under the conditions of overall tritium emission reductions from the Cernavodă NPP following the operation of the CTRF.

Anticipated emissions associated with the operation of the CTRF were estimated based on the operational experience of other similar facilities, and the cumulative emissions of the CTRF and the two operating CANDU units after the first year of operation of the CTRF were conservatively estimated by applying the lowest detritiation factor considered by the project designer.

Also, both the model for calculating the exposure of the representative person in the population and the assessments of the radiological consequences for the environment and the population following an accident at the CTRF use conservative assumptions so that the results of the estimates are covering the worst-case scenario.

From a non-radiological point of view, estimates of greenhouse gas emissions and the impact of potential adverse effects were made on the basis of conservative assumptions covering the worst-case scenario.

Estimates of emissions, effluents, waste and significant adverse effects were based on information from the CTRF Conceptual Project.

Conclusions

The radiological impact on environmental factors associated with the operation of the CTRF is due to tritium emissions in the form of liquid and gaseous effluents from the plant. These emissions have been estimated by the CTRF project designer at a level that is an order of magnitude below that currently achieved by the combined emissions from Units 1 and 2. From this point of view, the radiological impact on the environment due solely to the operation of the CTRF was estimated to be insignificant, local and with short-term effects. However, as the operation of the CTRF will gradually reduce the tritium concentration in the moderator and primary heat transfer systems of Units 1 and 2, which will create the conditions for a corresponding reduction of tritium emissions from the site, the cumulative radiological impact associated with the operation of the CTRF and the two units of the plant can be assessed to be positive, local and with long term effects.

The non-radiological impact on environmental factors, both direct and cumulative, will be insignificant, local, reversible and short term, taking into account the location of the CTRF within the Cernavodă NPP perimeter, the small size of the detritiation facility, the connection to NPP utilities and the application of NPP procedures for chemical and waste management.

10. LIST OF REFERENCES

1. Nuclearelectrica S.A. National Society, Presentation Memorandum - Construction works for Heavy Water Tritium Removal Facility, Variant for authorities - May 2019.
2. Institutul Național de Cercetare - Dezvoltare pentru Tehnologii Criogenice și Izotopice ICSI Rm. Vâlcea, Studiu de fezabilitate pentru instalația de detritiere CNE Cernavodă Rev.11, cod document 79-38500-SF-001, 2018.
3. Dan Galeriu, Calcul dispersie - Screening preliminar privind impactul tritiului în atmosfera – aferent efluentului atmosferic de la CTRF - funcționare normală, cod : 79-38500-SPIT-613-01 rev 0, Noiembrie 2014.
4. Centrul de Inginerie Tehnologica Obiective Nucleare Bucuresti Magurele RATEN CITON, Planul conceptual de dezafectare, cod 79-38500-CTRF-PT/DEZ1 rev. 3, Octombrie 2014.
5. CNE Cernavoda Plan de urgenta in caz de accidente majore in care sunt implicate substante periculoase, 2021.
6. S.N. Nuclearelectrica S.A., CNE Cernavoda, Raport informativ IR-38500-005 rev 0. Iulie 2020 Documentatie suport pentru obtinerea avizului sanitar de amplasare si constructie CTRF.
7. Design requirements HVAC 79-73590-613-DR-1 rev.3.
8. SC Cepstra Grup SRL Bilanțul de mediu nivel I pentru SNN S.A.- Sucursala CNE Cernavodă decembrie 2017.
9. EMEP/EEA air pollutant emission inventory guidebook - Publications Office of the European Union, 2019.
10. OM nr. 3299/2012 pentru aprobarea metodologiei de realizare și raportare a inventarelor privind emisiile de poluanți în atmosferă.
11. CANDESCO a KINETRICS Company, CTRF Evaluation of Design Options for Hydrogen Safety- KI CTRF-00084-0, Martie 2011.
12. Autorizatia de Gospodărire a Apelor Modificatoare a Autorizației nr. 58/07.2021, Nr. 72 din 06.09.2021 pentru CNE Cernavodă U1 și U2.
13. RAN/ CITON/CNE Cernavoda, CTRF, Managementul deșeurilor radioactive CTRF79-79000-CTRF-MT-1, Rev1, 2013.
14. 79-38500-TR-CTRF 001, edition 2014- Evaluation of Tritium Release for CTRF Normal Operation.
15. CNE Cernavodă, Raportul Final de Securitate, 2019 - Capitolul 2 "Caracteristicile amplasamentului", rev. RFS Cernavodă U2 din 2020.
16. Regia Autonoma pentru Activitati Nucleare CITON- Sucursala de Inginerie Tehnologica Obiective Nucleare „Studiu tehnic pentru evaluarea amplasamentului Instalatiei de detritiere CNE Cernavoda pe locul fostei statii de productie hidrogen si analiza preliminară privind pericolul unei explozii potientiale asupra vecinatatilor” 79-38500-613-SA-SN-1, rev 1, 6.10.2011.
17. Cernavoda Tritium Removal Facility, Evaluation of Tritium Release for CTRF Normal Operation, 79-38500-TR-CTRF-001, 2014.
18. OCON ECORISC S.R.L., Raport de Securitate (SEVESO), Ed. 2018, Rev. 1, 2021.
19. Niculiță Mihai, Rusu Constantin – Cap. 5 – Clima României în Curs – Geografia fizică a României, Editura Universității Alexandru Ioan Cuza din Iași, 2010.
20. Posea Grigore, Zăvoianu Ion și Bogdan Octavia – Geografia României, V - Câmpia Română, Dunarea, Podișul Dobrogei, Litoralul românesc al Mării Negre și Platforma Continentală, Editura Academiei Române, București, 2005;
21. ANM (Agenția Națională de Meteorologie) – Studiul meteorologic privind amplasamentul CNE Cernavodă, 2019.
22. Institutul de Meteorologie, Hidrologie și Gospodărire a Apelor- Reactualizarea studiului meteorologic și de dispersie a poluanților în zona CNE Cernavodă- octombrie 2000.
23. Institutul de Meteorologie și Hidrologie- Studiu meteorologic și de dispersie a poluanților în zona CNE Cernavodă Unitatea 1- decembrie 1987.
24. KINETRICS Company, CTRF process Technologies- A Review of International OPEX and the ICSI Pilot Plant K-415484-TRF-0001 R00, Mai 2015
25. 79/82-01551-AR-022 Servicii de analiza a datelor istorice inregistrate si prognoze necesare pentru caracterizarea sistematica a pericolelor externe de origine naturala aplicabile amplasamentului CNE Cernavoda – Meteorologie, ANM, Noiembrie 2018.

26. Pruppacher, H.R. și Klett, J.D. – Microphysics of Clouds and Precipitation. A doua editie, Kluwer Academic, Dordrecht, 1997.
27. Webb, J. D. C., Elsom, D. M., & Meaden, G. T. - Severe hailstorms in Britain and Ireland, a climatological survey and hazard assessment. Atmospheric Research, 93(1), 587-606, 2009.
28. ECA&D - Setul de date E-OBS din proiectul EU-FP6 UERRA (<http://www.uerra.eu>) și furnizorii de date din proiectul ECA & D (<https://www.ecad.eu>), 2018.
29. 79/82-01551-AR-023 "Servicii de analiza a datelor istorice inregistrate si prognoze necesare pentru caracterizarea sistematica a pericolelor externe de origine naturala aplicabile amplasamentului CNE Cernavoda – Hidrologie, INHGA, Noiembrie 2018".
30. Antonescu, B., & Bell, A. (2015). Tornadoes in Romania. Monthly Weather Review, 143(3), 689-701.
31. CNE Cernavodă, Raport informativ - Limite derivate de evacuare pentru CNE Cernavodă, IR96002-027, rev.1., 01.01.2015.
32. Protocol Autoritati-CNE, scrisoare Autoritati_CNE17, nr. 112 din 07.03.2017.
33. Niculescu, Bogdan. (2018). Geophysical and Geological Investigations of the Late Jurassic–Early Cretaceous Aquifer in Cernavodă Area, South Dobrogea (Romania). 10.5593/sgem2018/1.1/S05.103.
34. Direcția județeană de statistica din Constanța (2020) Anuarul statistic al Județului Constanta 2020 [Accesat la 06/10/2021].
35. Institutul Național de Statistică (2012) Press Release on the provisional results of the 2011 Population and Housing Census.
36. NSG-3.1 - Extenal Human Induced Hazards in Site Evaluation for Nuclear Installations, Vienna, 2002.
37. Direcția județeană de statistică Constanța (2020) Statistical Book of Constanta County 2020.
38. SC Cepstra Grup SRL, Raport cu privire la Bilanțul de mediu nivel II pentru SNN S.A.- Sucursala CNE Cernavodă – decembrie 2017.
39. Bănărescu (P.), 1964. Fauna Republicii Populare Române, Pisces-Osteichthyes. Academia R.P.R. București, p. 962.
40. Bănățean-Dunea (I.), Corpade (AM), Grozea (A.), Nicolin (A.), Corpade(A.), Osman (A.), Bostan (C.), Crista (N.G.), 2015 - Ghid sintetic de monitorizare a speciilor comunitare de pești din România. Casa Cărții de Știință Cluj-Napoca. Publicație realizată în cadrul Proiectului „Monitorizarea stării de conservare a speciilor și habitatelor din România în baza articolului 17 din Directiva Habitate”, proiect finanțat prin Programul Operațional Sectorial Mediu (POS Mediu) 2007-2013.
41. Bibby (C.), Jones (M.), Mardsen (S.), et. Munteanu (D.) (adaptare), 2000 – Metode de teren pentru studiul păsărilor. Metode de evaluare a abundenței păsărilor. 122 p. BirdLife International. S.O.R. Cluj.
42. Botnariuc (N.), Tatole (V). (eds.), 2005 - Cartea roșie a vertebratelor din România. 260 p. Muzeul Național de Istorie Naturală "Grigore Antipa", București.
43. Bușniță (TH.) și Alexandrescu (I.), 1963.- Atlasul peștilor din apele R.P.R. Ed. Științifică. București, p. 270.
44. Călinescu (R.), 1956 – Sciuridele din R.P.R. Editura Științifică. 123 p.
45. Dihoru (GHE.), Negrean (G.) 2009 - Cartea rosie a plantelor vasculare din Romania. Editura Academiei Romane, Bucuresti.
46. Dincă (V.E), Cuvelier (S.), Molgaard (M.S.), 2011 – Distribution and conservation status of Pseudophilotes bavius (Eversmann, 1832) (Lepidoptera: Lycaenidae) in Dobrogea (south-eastern Romania). Phegea 39 (2): 59 – 67.
47. Dănila (I.), 1986 - Contribuții la cunoașterea caracteristicilor bioecologice și răspândirea popândăului (Citellus citellus L.) în România. Hierasus, Botoșani, vol. 6, pag. 273-282.
48. Doniță (N), Popescu (A), Paucă-Comănescu (M), Mihăilescu (S.), Biriș (I.A.), 2005 – Habitatele din Romania. Editura tehnică silvică București.
49. Fuhn (I. E.), Vancea (ȘT.), -1960-: Fauna R.P.R. Amphibia. Vol. XIV, fasc. 1, Ed. Academiei R.P.R., București, 288 pp.
50. Hagemeyer (W. J. M.), Blair (M. J.), 1997 - The EBCC Atlas of European breeding birds. T. & A.D. Poyser. London.

51. Hamar (M.), Şutova (M.), 1965 - Ecologic study of mammals (Mammalia) from agricultural fields of Dobrogea and the Bărăgan. *Comunicări de Zoologie, Societatea de Ştiinţe Biologice* 3: 37-66.
52. del Hoyo (J.), Elliott (A.) & Sargatal (J.), 1992 - Handbook of the Birds of the World. Vol. 1: Ostrich to Ducks. Lynx Edicions, Barcelona, 696 p.
53. del Hoyo (J.), Elliott (A.) & Sargatal (J.), 2002 - Handbook of the Birds of the World. Vol. 7: Jacamars to Woodpeckers. Lynx Edicions, Barcelona.
54. Ionescu (O.), Ionescu (G.), Adamescu (M.), Cotovelea (A.), 2013- Ghid sintetic de monitorizare pentru speciile de mamifere de interes comunitar din România. Editura Silvică. Publicație realizată în cadrul Proiectului „Monitorizarea stării de conservare a speciilor și habitatelor din România în baza articolului 17 din Directiva Habitate”, proiect finanțat prin Programul Operațional Sectorial Mediu (POS Mediu) 2007-2013, ISBN: 978 - 606 - 8020 -37-2.
55. Iorgu (I.Şt.) et all., 2015 -Ghid Sintetic pentru Monitorizarea Speciilor de Nevertebrate de Interes Comunitar din România. Realizat în proiectul- Monitorizarea stării de conservare a speciilor și habitatelor din România în baza articolului 17 din Directiva Habitate Proiect co-finanțat din Fondul European pentru Dezvoltare Regională Material editat de Asocieria S.C. Compania de Consultanță și Asistență Tehnică S.R.L. și S.C. Integra Trading S.R.L. București 2015 ISBN 978-606-92462-3-8.
56. Kryštufek (B.), Vohralik (V.), 2009 – Mammals of Turkey and Cyprus Rodentia II. *Zalazba Annales, Koper*, 374 p.
57. Munteanu (D.), 2001 – Dicționar poliglot al speciilor de păsări din România. SOR. Cluj-Napoca. 14. 3.
58. Murariu (D.), Munteanu (D.), 2005. Fauna României, Mammalia-Carnivora, vol. XVI, Fascicula 5, Editura Academiei Române, București.
59. Nechay (G.), 2000 - Status of hamsters *Cricetus cricetus*, *Cricetus migratorius*, *Mesocricetus Newtoni* and other hamster species in Europe, Vol. 106. Council of Europe, Strasbourg.
60. Platteuw (M.), Kiss (J. B.), Sadoul (N.), Zhmud (M. Y.), 2004 – Colonial Waterbirds and their habitat use in the Danube Delta. RIZA Report 2004.002. ISBN 90.369.5658.7. pp. 3 – 168.
61. Popescu (A.), Murariu (D.), 2001 - Fauna României, Mammalia, Rodentia. Editura Academiei Române, București. Vol.16, pag. 1-214.
62. Rakosy (L.), Mihali (C.V.), Tóth (A.), Varga (Z.), 2012 – Taxonomic review of *Euphydryas maturna* (Linnaeus, 1758) (Lepidoptera, Nymphalidae) with description of a new subspecies from Dobrogea (Romania) and notes on conservation biology. *Acta zoologica Academiae Scientiarum Hungaricae* 58(2):145-161.
63. Rákosy (L.), Székely (L.), 1996 - Macrolepidopterele din sudul Dobrogei. — *Entomologica Romanica* 1: 17–62.
64. Székely (L.), 2012 - Fluturi de noapte din România 3 - Geometridae – 2- Larentiinae 1. / 6 color pl., 186 pp., Disz – Tipó, Săcele.
65. Török (ZS.), Ghira (I.), Sas (I.), Zamfirescu (ŞT.), 2013 – Ghid sintetic demonitorizare a speciilor comunitare de reptile și amfibieni din România. Editura Centrul de Informare Tehnologic Delta Dunării, Tulcea, România, ISBN 978-973-88117-6-8DOI: 10.7427/DDI.B.01.2013.
66. *****, 1979 - Directiva Consiliului European nr. 79/409/EEC din 2 aprilie 1979 privind conservarea păsărilor sălbatice (Birds Directive) - ultima modificare în anul 2013 ca urmare a aderării Croației la UE.
67. ***** - 1979a - Convention on the Conservation of European Wildlife and Natural Habitats - the Bern Convention. <http://conventions.coe.int/Treaty/en/Treaties/Html/104.htm>.
68. ***** - 1979b - The Convention on the Conservation of Migratory Species of Wild Animals - CMS / Bonn Convention – (<http://www.cms.int>).
69. *****, 1992 - Directiva Consiliului Uniunii Europene nr.92/43/1992 privind conservarea habitatelor naturale, faunei și florei sălbatice (Habitats Directive) – ultima modificare în anul 2013 ca urmare a aderării Croației la UE.
70. *****, 2006. Council Directive 2006/105/EC of 20 November 2006 adapting Directives 73/239/EEC, 74/557/EEC and 2002/83/EC in the field of environment, by reason of the accession of Bulgaria and Romania, Official Journal of the European Union, L 363 (din 20 decembrie 2006), Luxembourg, pp 368 – 408.

71. *****, 2009. DIRECTIVA 2009/147/CE A PARLAMENTULUI EUROPEAN ȘI A CONSILIULUI din 30 noiembrie 2009 privind conservarea păsărilor sălbatice.
72. *****, 2007 - Ordonanță de Urgență nr. 57 din 20 iunie 2007 privind regimul ariilor naturale protejate, conservarea habitatelor naturale, a florei și faunei sălbatice.
73. *****, 2015-Editor: Fundația Centrul Național pentru Dezvoltare Durabilă. – Atlas al speciilor de păsări de interes comunitar din Romania - Programul Operațional Sectorial – Mediu Proiect: 36586 SMIS-CSNR „Sistemul național de gestiune și monitorizare a speciilor de păsări din România în baza articolului 12 din Directiva Păsări”.
74. *****, Formular standard Natura 2000 pentru ROSPA0007 - Balta Vederosa
75. *****, Plan de Management pentru ariile naturale protejate: ROSCI0071 Dumbrăveni – Valea Urluia – Lacul Vederosa, ROSPA 0036 Dumbrăveni, ROSPA 0001 Aliman-Adamclisi, ROSPA 0007 Balta Verderosa, 2361 Rezervația naturală Pădurea Dumbrăveni, 2350 Rezervația Naturală Pereții Calcaroși de la Petroșani – Comuna Deleni, 2351 Rezervația Naturală Locul Fosilifer Aliman, IV.30 Rezervația naturală Lacul Vederosa.
76. *****, Formular standard Natura 2000 pentru ROSCI0278 – Bordușani-Borcea.
77. *****, Formular standard Natura 2000 pentru ROSCI0172 - Pădurea și Valea Canaraua Fetii – Iortmac.
78. *****, Formular standard Natura 2000 pentru ROSPA0002 – Allah Bair Capidava.
79. *****, Formular standard Natura 2000 pentru ROSPA0012 – Brațul Borcea.
80. *****, Plan de Management pentru ariile naturale protejate ROSCI0022 Canaralele Dunării, ROSCI0053 Dealul Allah Bair, ROSPA0002 Allah Bair Capidava, ROSPA0017 Canaralele de la Hârșova, ROSPA0039 Dunăre-Ostroave, Reciful neojurassic de la Topalu (2352), Reciful fosilifer Seimenii Mari (2355), Dealul Allah Bair (2367), Ostrovul Soimul (IV.19.), Celea Mare-Valea lui Ene (IV.24), Pădurea Cetate (IV.25.), Pădurea Bratca (IV.26), Locul fosilifer Cernavodă (2.534), Canaralele din Portul Hârșova (2.369).
81. *****, INCDDD, 2009 - Contract nr. 397 / 2009 „Completarea studiului de impact de mediu referitor la finalizarea investiției CNE Cernavodă Unitățile 3 și 4, privind impactul asupra biodiversității din zona de evacuare în Dunăre a apei de răcire, conform solicitărilor Ministerului Mediului.
82. *****, INCDDD, 2010 Contract 421- Evaluarea adecvată a impactului de mediu a Unităților 3 și 4.
83. Portalul cu Informații privind Schimbările Climatice al Băncii Mondiale - <https://climateknowledgeportal.worldbank.org/country/romania>
84. IR-96200-054: "Rezultatele monitorizării factorilor de mediu și al nivelului radioactivității în zona Cernavodă, perioada 1996-2020", revizia 0
85. <https://www.climate.gov/news-features/understanding-climate/climate-change-atmospheric-carbon-dioxide>
86. Institutul Național de Cercetare - Dezvoltare pentru Tehnologii Criogenice și Izotopice ICSI Rm. Vâlcea, Studiu al impactului funcționării centralei nucleare-electrice de la Cernavodă asupra organismelor acvatice și terestre din zona de influență a acesteia. Raport final, Rev. 0, 2012.
87. Gogoșe-Nistoran, D., Ionescu, C., Opreș, I., Enache, I., 2021. Extreme Heatwave Scenarios with Impact on Thermal Regime of Dâmbovița River in Bucharest, Romania. Presented at the IOP Conference Series: Earth and Environmental Science, IOP Publishing, p. 012026.
88. Lhotka, O., Kyselý, J., Farda, A., 2018. Climate change scenarios of heat waves in Central Europe and their uncertainties. Theoretical and applied climatology 131, 1043–1054.
89. RD-01364-RP04 “Procesul controlul materialelor radioactive”.
90. SI-01365-RP07 “Gospodărirea deșeurilor radioactive la CNE Cernavoda”.
91. Ming, A., Rowell, I., Lewin, S., Rouse, R., Aubry, T., Boland, E., 2021. Key messages from the IPCC AR6 climate science report.
92. Actualizare Plan urbanistic general oraș Cernavoda, jud. Constanta, 2011.
93. Groove Hour – White Space, Strategia de dezvoltare integrată a orașului Cernavoda 2015-2020.
94. Institutul Național de Sanatate Publica Bucuresti, “Studiul de evaluare a impactului radiologica supra starii de sanatate a populatiei din zona de influenta CNE Cernavoda in relatie cu functionarea normala a instalatiei de detritiere CNE Cernavoda (CTRF)”, martie 2015.
95. CTRF Accident Analysis Report for Public Dose, KI CTRF-00437 Rev 05, April 21, 2021.

- 96.** Institutul National de Sanatate Publica Bucuresti, Studiul de evaluare a impactului radiologic asupra starii de sanatate a populatiei generat de operarea CNE-Cernavoda din arealul de 30 km in jurul obiectivului, 2018.
- 97.** J. Garnier-Laplace and S. Roussel-Debet, Radionuclide fact sheet Carbon-14 and the environment, August 2001, https://www.irsn.fr/EN/Research/publications-documentation/radionuclides-sheets/environment/Documents/Carbone_UK.pdf
- 98.** Contract de servicii nr. 1078/ 2012 - Servicii de monitorizare a impactului funcționării CNE Cernavodă asupra biotei acvatice și terestre - Raport anul 4.
- 99.** Cernavoda Tritium Removal Facility On-site Dose Assessment, KI CTRF-00396-1, Candesco, nov. 24, 2014.
- 100.** Bojariu, R., M-V Bîrsan, Cică R., Velea L., Burcea S., Dumitrescu A., Dascalu S.-I., Gothard M., Dobrinescu A., Cărbunaru F., Marin L., 2015. Schimbările climatice - de La bazele fizice La riscuri și adaptare. Editura Printech, București, 2015, ISBN 978- 606-23-0363-1,200 pp. DOI: 10.13140/RG.2.1.1341.0729.
- 101.** Thomson, A.M., Calvin, K.V., Smith, S.J., Kyle, G.P., Volke, A., Patel, P., Delgado-Arias, S., Bond-Lamberty, B., Wise, M.A., Clarke, L.E., 2011. RCP4.5: a pathway for stabilization of radiative forcing by 2100. Climatic change 109, 77–94.
- 102.** Riahi, K., Rao, S., Krey, V., Cho, C., Chirkov, V., Fischer, G., Kindermann, G., Nakicenovic, N., Rafaj, P., 2011. RCP 8.5—A scenario of comparatively high greenhouse gas emissions. Climatic change 109, 33–57.
- 103.** IPCC, 2014: Climate Change 2014: Synthesis Report. Contribution of Working Groups I, II and III to the Fifth Assessment Report of the Intergovernmental Panel on Climate Change [Core Writing Team, R.K. Pachauri and L.A. Meyer (eds.)]. IPCC, Geneva, Switzerland, 151 p.
- 104.** SNN, CNE Cernavoda. Programul de monitorizare a radioactivității din mediu pentru CNE Cernavodă - SI-01365-RP015 rev.3.
- 105.** CNE Cernavoda, Procesul de planificare si pregatire pentru situatii de urgenta, RD-01364-RP008 rev. 9, 2021.
- 106.** NSN-02 Norma de securitate nucleară privind proiectarea și construcția centralelor nucleare electrice.
- 107.** NSN-24, Normele privind analizele deterministe de securitate nucleară pentru instalațiile nucleare, din 22.10.2019.
- 108.** UNSCEAR 2008 Report, SOURCES AND EFFECTS OF IONIZING RADIATION, VOLUME I, New York, 2010.
- 109.** Plan de Urgență Internă pentru amplasamentul SNN SA – CNE Cernavoda, Ediția 2018, Revizia 2, 2021.
- 110.** National Commission for Nuclear Activities Control, National Report on the Implementation of the Stress Tests, December 2011.
- 111.** SC GEOTEHNICA DESIGN SRL, Studiu geotehnic. Amplasament CTRF-CNE Cernavodă, Cod document: 79-28000-SG-1199-11, aprilie 2011.
- 112.** WSP UK Ltd, Studiu privind Evaluarea Impactului Social și asupra Mediului, august 2021.

Annex 2 CTRF layout

INCADRARE IN ZONA
SCARA 1 : 5 000



S.C. RAMBOLL SOUTH EAST EUROPE S.R.L.

Annex 3 Location alternative 1

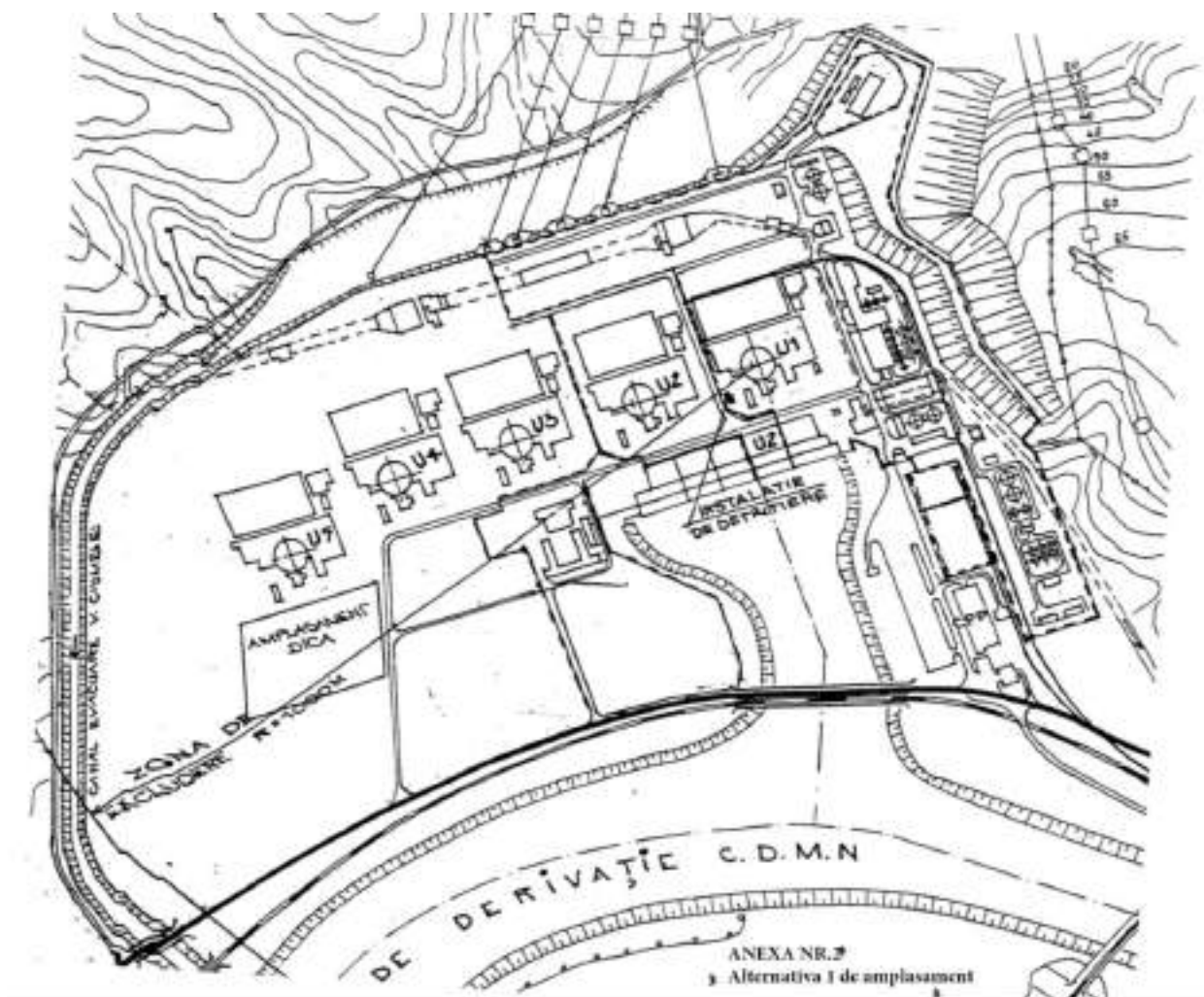

Annex 4 Location alternative 2

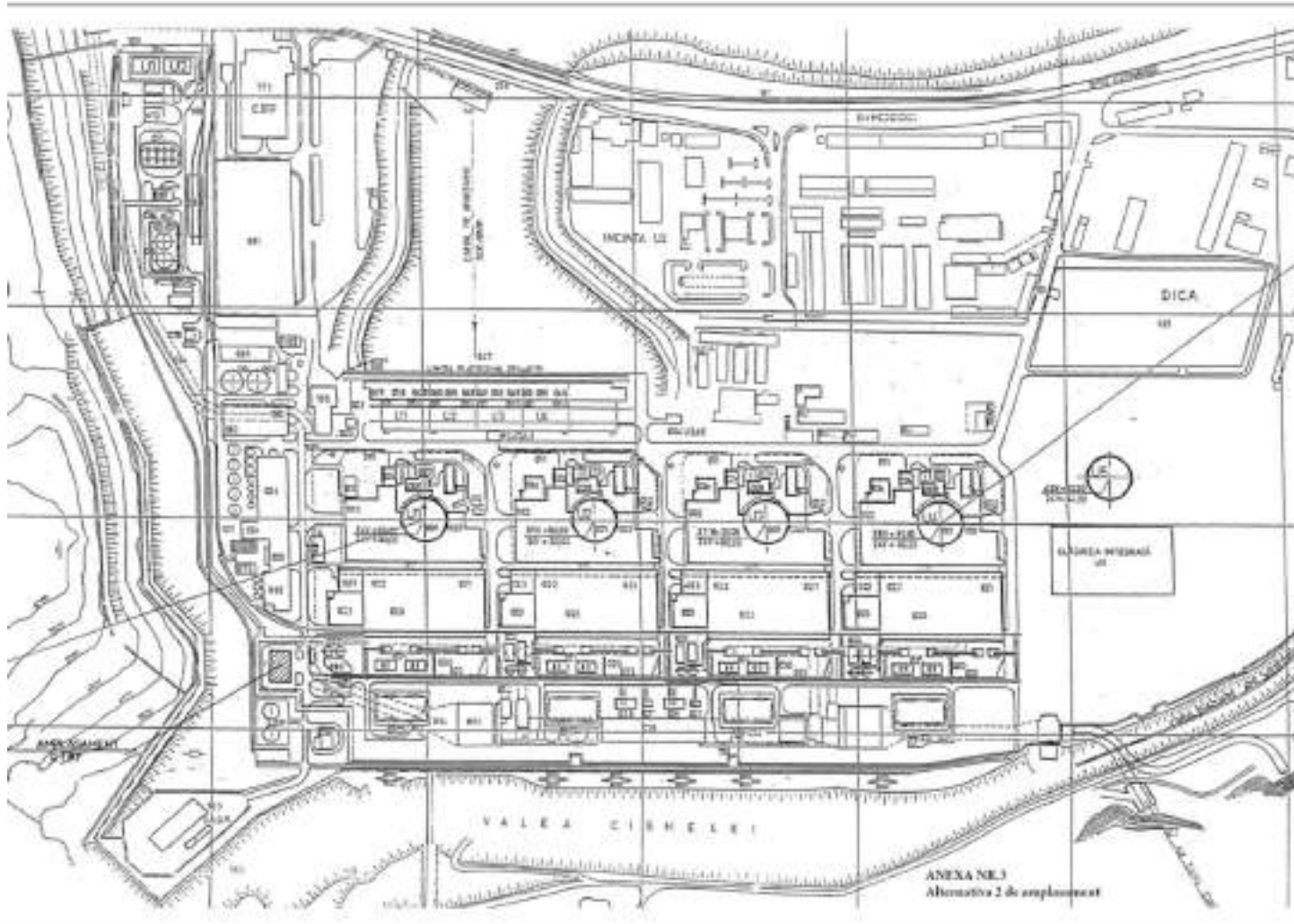

Annex 5 Populations of plant species of conservation interest reported in Natura 2000 sites in the Area of Interest

Species code	Species name	Site presence	Population/ Abundance	Site code	Site name
2236	<i>Campanula romanica</i>	P	R	ROSCI0022	Canaralele Dunarii
2236	<i>Campanula romanica</i>	P	R	ROSCI0053	Dealul Alah Bair (Allah Bair Hill)
2253	<i>Centaurea jankae</i>	P	R	ROSCI0071	Dumbraveni - Valea Urluia - Lacul Vederosa (Dumbraveni - Urluia Valley - Vederosa Lake)
6927	<i>Himantoglossum jankae</i>	P	R	ROSCI0071	Dumbraveni - Valea Urluia - Lacul Vederosa (Dumbraveni - Urluia Valley - Vederosa Lake)
6927	<i>Himantoglossum jankae</i>	P	min.29 i	ROSCI0172	Padurea si Valea Canaraua Fetii - Iortmac (Canaraua Fetii Forest and Valley – Iortmac)
1428	<i>Marsilea quadrifolia</i>	P	min. 1000 i	ROSCI0172	Padurea si Valea Canaraua Fetii - Iortmac (Canaraua Fetii Forest and Valley – Iortmac)
2079	<i>Moehringia jankae</i>	P	V	ROSCI0022	Canaralele Dunarii
6948	<i>Pontechium maculatum subsp. maculatum</i>	P	P	ROSCI0071	Dumbraveni - Valea Urluia - Lacul Vederosa (Dumbraveni - Urluia Valley - Vederosa Lake)
6948	<i>Pontechium maculatum subsp. maculatum</i>	P	P	ROSCI0172	Padurea si Valea Canaraua Fetii - Iortmac (Canaraua Fetii Forest and Valley – Iortmac)
2125	<i>Potentilla emilii-popii</i>	P	R	ROSCI0053	Dealul Alah Bair (Allah Bair Hill)
2125	<i>Potentilla emilii-popii</i>	P	R	ROSCI0071	Dumbraveni - Valea Urluia - Lacul Vederosa (Dumbraveni - Urluia Valley - Vederosa Lake)
2125	<i>Potentilla emilii-popii</i>	P	R	ROSCI0172	Padurea si Valea Canaraua Fetii - Iortmac (Canaraua Fetii Forest and Valley – Iortmac)
2093	<i>Pulsatilla grandis</i>	P	R	ROSCI0053	Dealul Alah Bair (Allah Bair Hill)

Annex 6 Populations of invertebrate species of conservation interest reported in Natura 2000 sites in the Area of Interest

Species code	Species name	Site presence	Population/ Abundance	Site code	Site name
4056	<i>Anisus vorticulus</i>	P	R	ROSCI0022	Canaralele Dunarii
4028	<i>Catopta thrips</i>	P	P	ROSCI0071	Dumbraveni - Valea Urluia - Lacul Vederosa (Dumbraveni - Urluia Valley - Vederosa Lake)
1088	<i>Cerambyx cerdo</i>	P	P	ROSCI0172	Padurea si Valea Canaraua Fetii - Iortmac (Canaraua Fetii Forest and Valley – Iortmac)

1074	<i>Eriogaster catax</i>	P	R	ROSCI0071	Dumbraveni - Valea Urluia - Lacul Vederioasa (Dumbraveni - Urluia Valley - Vederioasa Lake)
1074	<i>Eriogaster catax</i>	P	C	ROSCI0172	Padurea si Valea Canaraua Fetii - Iortmac (Canaraua Fetii Forest and Valley – Iortmac)
6169	<i>Euphydryas maturna</i>	P	P	ROSCI0172	Padurea si Valea Canaraua Fetii - Iortmac (Canaraua Fetii Forest and Valley – Iortmac)
6199	<i>Euplagia quadripunctaria</i>	P	R	ROSCI0172	Padurea si Valea Canaraua Fetii - Iortmac (Canaraua Fetii Forest and Valley – Iortmac)
1083	<i>Lucanus cervus</i>	P	R	ROSCI0071	Dumbraveni - Valea Urluia - Lacul Vederioasa (Dumbraveni - Urluia Valley - Vederioasa Lake)
1083	<i>Lucanus cervus</i>	P	C	ROSCI0172	Padurea si Valea Canaraua Fetii - Iortmac (Canaraua Fetii Forest and Valley – Iortmac)
1060	<i>Lycaena dispar</i>	P	C	ROSCI0071	Dumbraveni - Valea Urluia - Lacul Vederioasa (Dumbraveni - Urluia Valley - Vederioasa Lake)
1060	<i>Lycaena dispar</i>	P	C	ROSCI0172	Padurea si Valea Canaraua Fetii - Iortmac (Canaraua Fetii Forest and Valley – Iortmac)
4053	<i>Paracaloptenus caloptenoides</i>	P	R	ROSCI0172	Padurea si Valea Canaraua Fetii - Iortmac (Canaraua Fetii Forest and Valley – Iortmac)
4043	<i>Pseudophilotes bavius</i>	P	R	ROSCI0172	Padurea si Valea Canaraua Fetii - Iortmac (Canaraua Fetii Forest and Valley – Iortmac)

Annex 7 Populations of fish species of conservation interest reported in Natura 2000 sites in the Area of Interest

Species code	Species name	Site presence	Population/ Abundance	Site code	Site name
4125	<i>Alosa immaculata</i>	P	P	ROSCI0022	Canaralele Dunarii
4125	<i>Alosa immaculata</i>	R	R	ROSCI0022	Canaralele Dunarii
4127	<i>Alosa tanaica</i>	P	5000-10000i	ROSCI0022	Canaralele Dunarii
1130	<i>Aspius aspius</i>	P	100000-500000i	ROSCI0022	Canaralele Dunarii
1130	<i>Aspius aspius</i>	P	C	ROSCI0071	Dumbraveni - Valea Urluia - Lacul Vederioasa (Dumbraveni - Urluia Valley - Vederioasa Lake)
1130	<i>Aspius aspius</i>	P	P	ROSCI0172	Padurea si Valea Canaraua Fetii - Iortmac (Canaraua Fetii Forest and Valley – Iortmac)
6963	<i>Cobitis taenia Complex</i>	P	100000-500000i	ROSCI0022	Canaralele Dunarii
6963	<i>Cobitis taenia Complex</i>	P	P	ROSCI0071	Dumbraveni - Valea Urluia - Lacul Vederioasa (Dumbraveni - Urluia Valley - Vederioasa Lake)
2484	<i>Eudontomyzon mariae</i>	P	0-1000i (V)	ROSCI0022	Canaralele Dunarii
2555	<i>Gymnocephalus baloni</i>	P	500000-900000i	ROSCI0022	Canaralele Dunarii

1157	<i>Gymnocephalus schraetzer</i>	P	100000-500000i	ROSCI0022	Canaralele Dunarii
1145	<i>Misgurnus fossilis</i>	P	10000-50000i	ROSCI0022	Canaralele Dunarii
1145	<i>Misgurnus fossilis</i>	P	C	ROSCI0071	Dumbraveni - Valea Urluia - Lacul Vederoasa (Dumbraveni - Urluia Valley - Vederoasa Lake)
1145	<i>Misgurnus fossilis</i>	P	P	ROSCI0172	Padurea si Valea Canaraua Fetii - Iortmac (Canaraua Fetii Forest and Valley – Iortmac) (Canaraua Fetii Forest and Valley – Iortmac)
2522	<i>Pelecus cultratus</i>	P	10000-50000i	ROSCI0022	Canaralele Dunarii
2522	<i>Pelecus cultratus</i>	P	R	ROSCI0071	Dumbraveni - Valea Urluia - Lacul Vederoasa (Dumbraveni - Urluia Valley - Vederoasa Lake)
2522	<i>Pelecus cultratus</i>	P	P	ROSCI0172	Padurea si Valea Canaraua Fetii - Iortmac (Canaraua Fetii Forest and Valley – Iortmac) (Canaraua Fetii Forest and Valley – Iortmac)
5339	<i>Rhodeus amarus</i>	P	50000-100000i	ROSCI0022	Canaralele Dunarii
5339	<i>Rhodeus amarus</i>	P	C	ROSCI0071	Dumbraveni - Valea Urluia - Lacul Vederoasa (Dumbraveni - Urluia Valley - Vederoasa Lake)
5339	<i>Rhodeus amarus</i>	P	V	ROSCI0172	Padurea si Valea Canaraua Fetii - Iortmac (Canaraua Fetii Forest and Valley – Iortmac) (Canaraua Fetii Forest and Valley – Iortmac)
6143	<i>Romanogobio kesslerii</i>	P	5000-10000i	ROSCI0022	Canaralele Dunarii
5329	<i>Romanogobio vladykovi</i>	P	100000-200000i	ROSCI0022	Canaralele Dunarii
5329	<i>Romanogobio vladykovi</i>	P	R	ROSCI0071	Dumbraveni - Valea Urluia - Lacul Vederoasa (Dumbraveni - Urluia Valley - Vederoasa Lake)
5329	<i>Romanogobio vladykovi</i>	P	P	ROSCI0172	Padurea si Valea Canaraua Fetii - Iortmac (Canaraua Fetii Forest and Valley – Iortmac) (Canaraua Fetii Forest and Valley – Iortmac)
5347	<i>Sabanejewia bulgarica</i>	P	50000-100000i	ROSCI0022	Canaralele Dunarii
1160	<i>Zingel streber</i>	P	5000-10000i	ROSCI0022	Canaralele Dunarii
1159	<i>Zingel zingel</i>	P	5000-10000i	ROSCI0022	Canaralele Dunarii

Annex 8 Populations of amphibian species of conservation interest reported in Natura 2000 sites in the Area of Interest

Species code	Species name	Site presence	Population/ Abundance	Site code	Site name
1188	<i>Bombina bombina</i>	P	P	ROSCI0022	Canaralele Dunarii
1188	<i>Bombina bombina</i>	P	C	ROSCI0071	Dumbraveni - Valea Urluia - Lacul Vederosa (Dumbraveni - Urluia Valley - Vederosa Lake)
1188	<i>Bombina bombina</i>	P	P	ROSCI0172	Padurea si Valea Canaraua Fetii - Iortmac (Canaraua Fetii Forest and Valley – Iortmac) (Canaraua Fetii Forest and Valley – Iortmac)
1188	<i>Bombina bombina</i>	P	P	ROSCI0278	Bordusani - Borcea
1188	<i>Bombina bombina</i>	P	P	ROSCI0319	Mlastina de la Fetesti (Fetesti Swamp)
1993	<i>Triturus dobrogicus</i>	P	P	ROSCI0022	Canaralele Dunarii
1993	<i>Triturus dobrogicus</i>	P	R	ROSCI0071	Dumbraveni - Valea Urluia - Lacul Vederosa (Dumbraveni - Urluia Valley - Vederosa Lake)
1993	<i>Triturus dobrogicus</i>	P	P	ROSCI0319	Mlastina de la Fetesti (Fetesti Swamp)

Annex 9 Populations of reptilian species of conservation interest reported in Natura 2000 sites in the Area of Interest

Species code	Species name	Site presence	Population/ Abundance	Site code	Site name
5194	<i>Elaphe sauromates</i>	P	V	ROSCI0071	Dumbraveni - Valea Urluia - Lacul Vederosa (Dumbraveni - Urluia Valley - Vederosa Lake)
5194	<i>Elaphe sauromates</i>	P	V	ROSCI0172	Padurea si Valea Canaraua Fetii - Iortmac (Canaraua Fetii Forest and Valley – Iortmac) (Canaraua Fetii Forest and Valley – Iortmac)
5194	<i>Elaphe sauromates</i>	P	V	ROSCI0412	Ivrinezu
1220	<i>Emys orbicularis</i>	P	P	ROSCI0022	Canaralele Dunarii
1220	<i>Emys orbicularis</i>	P	C	ROSCI0071	Dumbraveni - Valea Urluia - Lacul Vederosa (Dumbraveni - Urluia Valley - Vederosa Lake)
1220	<i>Emys orbicularis</i>	P	R	ROSCI0172	Padurea si Valea Canaraua Fetii - Iortmac (Canaraua Fetii Forest and Valley – Iortmac) (Canaraua Fetii Forest and Valley – Iortmac)
1220	<i>Emys orbicularis</i>	P	P	ROSCI0278	Bordusani - Borcea
1220	<i>Emys orbicularis</i>	P	P	ROSCI0319	Mlastina de la Fetesti (Fetesti Swamp)
1219	<i>Testudo graeca</i>	P	P	ROSCI0022	Canaralele Dunarii
1219	<i>Testudo graeca</i>	P	C	ROSCI0071	Dumbraveni - Valea Urluia - Lacul Vederosa (Dumbraveni

					- Urluia Valley - Vederoasa Lake)
1219	<i>Testudo graeca</i>	P	C	ROSCI0172	Padurea si Valea Canaraua Fetii - Iortmac (Canaraua Fetii Forest and Valley – Iortmac) (Canaraua Fetii Forest and Valley – Iortmac)
1219	<i>Testudo graeca</i>	P	P	ROSCI0412	Ivrinezu
1217	<i>Testudo hermanni</i>	P	V	ROSCI0071	Dumbraveni - Valea Urluia - Lacul Vederoasa (Dumbraveni - Urluia Valley - Vederoasa Lake)
1217	<i>Testudo hermanni</i>	P	V	ROSCI0172	Padurea si Valea Canaraua Fetii - Iortmac (Canaraua Fetii Forest and Valley – Iortmac) (Canaraua Fetii Forest and Valley – Iortmac)

Annex 10 Populations of mammal species of conservation interest reported in Natura 2000 sites in the Area of Interest

Species code	Species name	Site presence	Population/ Abundance	Site code	Site name
1355	<i>Lutra lutra</i>	P	40-50i	ROSCI0022	Canaralele Dunarii
1355	<i>Lutra lutra</i>	P	R	ROSCI0071	Dumbraveni - Valea Urluia - Lacul Vederoasa (Dumbraveni - Urluia Valley - Vederoasa Lake)
1355	<i>Lutra lutra</i>	P	P	ROSCI0172	Padurea si Valea Canaraua Fetii - Iortmac (Canaraua Fetii Forest and Valley – Iortmac) (Canaraua Fetii Forest and Valley – Iortmac)
1355	<i>Lutra lutra</i>	P	P	ROSCI0319	Mlastina de la Fetesti (Fetesti Swamp)
2609	<i>Mesocricetus newtoni</i>	P	P	ROSCI0022	Canaralele Dunarii
2609	<i>Mesocricetus newtoni</i>	P	P	ROSCI0071	Dumbraveni - Valea Urluia - Lacul Vederoasa (Dumbraveni - Urluia Valley - Vederoasa Lake)
2609	<i>Mesocricetus newtoni</i>	P	P	ROSCI0353	Pestera - Deleni
2609	<i>Mesocricetus newtoni</i>	P	P	ROSCI0412	Ivrinezu
1310	<i>Miniopterus schreibersii</i>	P	P	ROSCI0071	Dumbraveni - Valea Urluia - Lacul Vederoasa (Dumbraveni - Urluia Valley - Vederoasa Lake)
1310	<i>Miniopterus schreibersii</i>	R	R	ROSCI0071	Dumbraveni - Valea Urluia - Lacul Vederoasa (Dumbraveni - Urluia Valley - Vederoasa Lake)
1310	<i>Miniopterus schreibersii</i>	P	P	ROSCI0172	Padurea si Valea Canaraua Fetii - Iortmac (Canaraua Fetii Forest and Valley – Iortmac) (Canaraua Fetii Forest and Valley – Iortmac)
1310	<i>Miniopterus schreibersii</i>	R	P	ROSCI0172	Padurea si Valea Canaraua Fetii - Iortmac (Canaraua Fetii Forest and Valley – Iortmac) (Canaraua Fetii Forest and Valley – Iortmac)

1321	<i>Myotis emarginatus</i>	P	P	ROSCI0172	Padurea si Valea Canaraua Fetii - Iortmac (Canaraua Fetii Forest and Valley – Iortmac) (Canaraua Fetii Forest and Valley – Iortmac)
1304	<i>Rhinolophus ferrumequinum</i>	P	P	ROSCI0172	Padurea si Valea Canaraua Fetii - Iortmac (Canaraua Fetii Forest and Valley – Iortmac) (Canaraua Fetii Forest and Valley – Iortmac)
1303	<i>Rhinolophus hipposideros</i>	P	P	ROSCI0172	Padurea si Valea Canaraua Fetii - Iortmac (Canaraua Fetii Forest and Valley – Iortmac) (Canaraua Fetii Forest and Valley – Iortmac)
1302	<i>Rhinolophus mehelyi</i>	P	V	ROSCI0071	Dumbraveni - Valea Urluia - Lacul Vederuasa (Dumbraveni - Urluia Valley - Vederuasa Lake)
1302	<i>Rhinolophus mehelyi</i>	P	V	ROSCI0172	Padurea si Valea Canaraua Fetii - Iortmac (Canaraua Fetii Forest and Valley – Iortmac) (Canaraua Fetii Forest and Valley – Iortmac)
1335	<i>Spermophilus citellus</i>	P	P	ROSCI0022	Canaralele Dunarii
1335	<i>Spermophilus citellus</i>	P	C	ROSCI0071	Dumbraveni - Valea Urluia - Lacul Vederuasa (Dumbraveni - Urluia Valley - Vederuasa Lake)
1335	<i>Spermophilus citellus</i>	P	P	ROSCI0172	Padurea si Valea Canaraua Fetii - Iortmac (Canaraua Fetii Forest and Valley – Iortmac) (Canaraua Fetii Forest and Valley – Iortmac)
1335	<i>Spermophilus citellus</i>	P	P	ROSCI0353	Pestera - Deleni
1335	<i>Spermophilus citellus</i>	P	P	ROSCI0412	Ivrinezu
2635	<i>Vormela peregusna</i>	P	P	ROSCI0071	Dumbraveni - Valea Urluia - Lacul Vederuasa (Dumbraveni - Urluia Valley - Vederuasa Lake)
2635	<i>Vormela peregusna</i>	P	P	ROSCI0172	Padurea si Valea Canaraua Fetii - Iortmac (Canaraua Fetii Forest and Valley – Iortmac) (Canaraua Fetii Forest and Valley – Iortmac)

Annex 11 Populations of bird species of conservation interest reported in Natura 2000 sites in the Area of Interest

Species code	Species name	Site presence	Population Min./max. individuals / pairs	Abundance	Site code	Site name
A402	<i>Accipiter brevipes</i>	C	30-i	R	ROSPA0001	Aliman - Adamclisi
A402	<i>Accipiter brevipes</i>	R	15-18p	R	ROSPA0001	Aliman - Adamclisi
A402	<i>Accipiter brevipes</i>	C	30-i	C	ROSPA0002	Allah Bair - Capidava

A402	<i>Accipiter brevipes</i>	R	3-5p	C	ROSPA0002	Allah Bair - Capidava
A402	<i>Accipiter brevipes</i>	R	2-2p	P	ROSPA0012	Bratul Borcea (Borcea Arm)
A402	<i>Accipiter brevipes</i>	R	2-2p	C	ROSPA0039	Dunare - Ostroave
A086	<i>Accipiter nisus</i>	C	860-1370i	C	ROSPA0002	Allah Bair - Capidava
A298	<i>Acrocephalus arundinaceus</i>	R	-	C	ROSPA0007	Balta Vederoasa
A298	<i>Acrocephalus arundinaceus</i>	R	-	C	ROSPA0012	Bratul Borcea (Borcea Arm)
A298	<i>Acrocephalus arundinaceus</i>	R	-	C	ROSPA0054	Lacul Dunareni (Dunareni Lake)
A293	<i>Acrocephalus melanopogon</i>	C	-	R	ROSPA0007	Balta Vederoasa
A293	<i>Acrocephalus melanopogon</i>	R	-	R	ROSPA0012	Bratul Borcea (Borcea Arm)
A293	<i>Acrocephalus melanopogon</i>	R	-	R	ROSPA0039	Dunare - Ostroave
A293	<i>Acrocephalus melanopogon</i>	C	-	R	ROSPA0054	Lacul Dunareni (Dunareni Lake)
A296	<i>Acrocephalus palustris</i>	R	-	C	ROSPA0007	Balta Vederoasa
A295	<i>Acrocephalus schoenobaenus</i>	R	-	C	ROSPA0007	Balta Vederoasa
A295	<i>Acrocephalus schoenobaenus</i>	R	-	C	ROSPA0012	Bratul Borcea (Borcea Arm)
A295	<i>Acrocephalus schoenobaenus</i>	R	-	C	ROSPA0054	Lacul Dunareni (Dunareni Lake)
A297	<i>Acrocephalus scirpaceus</i>	R	-	C	ROSPA0007	Balta Vederoasa
A297	<i>Acrocephalus scirpaceus</i>	R	-	C	ROSPA0012	Bratul Borcea (Borcea Arm)
A297	<i>Acrocephalus scirpaceus</i>	R	-	C	ROSPA0054	Lacul Dunareni (Dunareni Lake)
A168	<i>Actitis hypoleucos</i>	C	-	C	ROSPA0007	Balta Vederoasa
A247	<i>Alauda arvensis</i>	P	-	P	ROSPA0001	Aliman - Adamclisi
A247	<i>Alauda arvensis</i>	R	-	C	ROSPA0002	Allah Bair - Capidava
A247	<i>Alauda arvensis</i>	C	-	C	ROSPA0007	Balta Vederoasa
A247	<i>Alauda arvensis</i>	R	-	P	ROSPA0012	Bratul Borcea (Borcea Arm)
A229	<i>Alcedo atthis</i>	R	70-80p	C	ROSPA0002	Allah Bair - Capidava
A229	<i>Alcedo atthis</i>	R	20-22p	R	ROSPA0007	Balta Vederoasa

A229	<i>Alcedo atthis</i>	R	80-100p	R	ROSPA0012	Bratul Borcea (Borcea Arm)
A229	<i>Alcedo atthis</i>	R	50-50p	R	ROSPA0039	Dunare - Ostroave
A229	<i>Alcedo atthis</i>	R	10-12p	R	ROSPA0054	Lacul Dunareni (Dunareni Lake)
A054	<i>Anas acuta</i>	C	120-150i	C	ROSPA0007	Balta Vederoasa
A054	<i>Anas acuta</i>	C	400-670i	C	ROSPA0054	Lacul Dunareni (Dunareni Lake)
A056	<i>Anas clypeata</i>	C	200-300i	C	ROSPA0007	Balta Vederoasa
A056	<i>Anas clypeata</i>	C	600-800i	C	ROSPA0054	Lacul Dunareni (Dunareni Lake)
A052	<i>Anas crecca</i>	C	200-400i	C	ROSPA0007	Balta Vederoasa
A052	<i>Anas crecca</i>	C	1000-1400i	C	ROSPA0054	Lacul Dunareni (Dunareni Lake)
A052	<i>Anas crecca</i>	W	1100-4000i	C	ROSPA0054	Lacul Dunareni (Dunareni Lake)
A050	<i>Anas penelope</i>	C	120-500i	C	ROSPA0007	Balta Vederoasa
A050	<i>Anas penelope</i>	C	120-500i	C	ROSPA0054	Lacul Dunareni (Dunareni Lake)
A053	<i>Anas platyrhynchos</i>	C	1200-1400i	C	ROSPA0007	Balta Vederoasa
A053	<i>Anas platyrhynchos</i>	R	120-i	C	ROSPA0007	Balta Vederoasa
A053	<i>Anas platyrhynchos</i>	W	4400-9000i	C	ROSPA0007	Balta Vederoasa
A053	<i>Anas platyrhynchos</i>	R	-	P	ROSPA0012	Bratul Borcea (Borcea Arm)
A053	<i>Anas platyrhynchos</i>	R	120-120p	P	ROSPA0039	Dunare - Ostroave
A053	<i>Anas platyrhynchos</i>	C	4000-7000i	C	ROSPA0054	Lacul Dunareni (Dunareni Lake)
A053	<i>Anas platyrhynchos</i>	R	20-30p	C	ROSPA0054	Lacul Dunareni (Dunareni Lake)
A053	<i>Anas platyrhynchos</i>	W	500-800i	C	ROSPA0054	Lacul Dunareni (Dunareni Lake)
A055	<i>Anas querquedula</i>	C	200-300i	C	ROSPA0007	Balta Vederoasa
A055	<i>Anas querquedula</i>	R	20-p	C	ROSPA0007	Balta Vederoasa
A055	<i>Anas querquedula</i>	R	-	R	ROSPA0012	Bratul Borcea (Borcea Arm)
A055	<i>Anas querquedula</i>	C	1500-1800i	C	ROSPA0054	Lacul Dunareni (Dunareni Lake)
A055	<i>Anas querquedula</i>	R	20-p	C	ROSPA0054	Lacul Dunareni (Dunareni Lake)

A051	<i>Anas strepera</i>	C	360-430i	C	ROSPA0007	Balta Vederoasa
A051	<i>Anas strepera</i>	C	360-430i	C	ROSPA0054	Lacul Dunareni (Dunareni Lake)
A041	<i>Anser albifrons</i>	W	300-400i	C	ROSPA0002	Allah Bair - Capidava
A041	<i>Anser albifrons</i>	W	1200-1400i	C	ROSPA0007	Balta Vederoasa
A041	<i>Anser albifrons</i>	W	13-30i	R	ROSPA0012	Bratul Borcea (Borcea Arm)
A041	<i>Anser albifrons</i>	C	2500-3000i	C	ROSPA0054	Lacul Dunareni (Dunareni Lake)
A041	<i>Anser albifrons</i>	W	500-1500i	C	ROSPA0054	Lacul Dunareni (Dunareni Lake)
A043	<i>Anser anser</i>	C	240-600i	P	ROSPA0007	Balta Vederoasa
A043	<i>Anser anser</i>	R	20-22p	P	ROSPA0007	Balta Vederoasa
A043	<i>Anser anser</i>	C	200-600i	C	ROSPA0054	Lacul Dunareni (Dunareni Lake)
A043	<i>Anser anser</i>	R	10-20p	C	ROSPA0054	Lacul Dunareni (Dunareni Lake)
A255	<i>Anthus campestris</i>	R	3600-4000p	R	ROSPA0001	Aliman - Adamclisi
A255	<i>Anthus campestris</i>	R	800-1200p		ROSPA0002	Allah Bair - Capidava
A256	<i>Anthus trivialis</i>	C	-	C	ROSPA0002	Allah Bair - Capidava
A404	<i>Aquila heliaca</i>	R	1-2i	C	ROSPA0001	Aliman - Adamclisi
A089	<i>Aquila pomarina</i>	C	150-200i	C	ROSPA0001	Aliman - Adamclisi
A089	<i>Aquila pomarina</i>	R	1-2p	C	ROSPA0001	Aliman - Adamclisi
A089	<i>Aquila pomarina</i>	C	2500-5000i	R	ROSPA0002	Allah Bair - Capidava
A028	<i>Ardea cinerea</i>	C	250-i	P	ROSPA0007	Balta Vederoasa
A028	<i>Ardea cinerea</i>	R	80-90p	P	ROSPA0007	Balta Vederoasa
A028	<i>Ardea cinerea</i>	R	50-50p	C	ROSPA0012	Bratul Borcea (Borcea Arm)
A028	<i>Ardea cinerea</i>	R	50-50p	C	ROSPA0039	Dunare - Ostroave
A029	<i>Ardea purpurea</i>	R	25-30p	R	ROSPA0007	Balta Vederoasa
A029	<i>Ardea purpurea</i>	R	90-120p	R	ROSPA0039	Dunare - Ostroave
A029	<i>Ardea purpurea</i>	C	120-150i	R	ROSPA0054	Lacul Dunareni (Dunareni Lake)

A029	<i>Ardea purpurea</i>	R	10-40p	R	ROSPA0054	Lacul Dunareni (Dunareni Lake)
A024	<i>Ardeola ralloides</i>	R	230-270p	R	ROSPA0007	Balta Vederoasa
A024	<i>Ardeola ralloides</i>	R	90-100p	R	ROSPA0012	Bratul Borcea (Borcea Arm)
A024	<i>Ardeola ralloides</i>	R	90-90p	R	ROSPA0039	Dunare - Ostroave
A024	<i>Ardeola ralloides</i>	C	234-340i	C	ROSPA0054	Lacul Dunareni (Dunareni Lake)
A024	<i>Ardeola ralloides</i>	R	80-120p	C	ROSPA0054	Lacul Dunareni (Dunareni Lake)
A221	<i>Asio otus</i>	R	-	C	ROSPA0001	Aliman - Adamclisi
A221	<i>Asio otus</i>	R	-	C	ROSPA0002	Allah Bair - Capidava
A221	<i>Asio otus</i>	R	-	R	ROSPA0007	Balta Vederoasa
A221	<i>Asio otus</i>	R	-	C	ROSPA0012	Bratul Borcea (Borcea Arm)
A221	<i>Asio otus</i>	R	-	R	ROSPA0054	Lacul Dunareni (Dunareni Lake)
A059	<i>Aythya ferina</i>	C	200-300i	P	ROSPA0007	Balta Vederoasa
A059	<i>Aythya ferina</i>	R	20-40p	P	ROSPA0007	Balta Vederoasa
A059	<i>Aythya ferina</i>	R	-	C	ROSPA0012	Bratul Borcea (Borcea Arm)
A059	<i>Aythya ferina</i>	R	80-80p	C	ROSPA0039	Dunare - Ostroave
A059	<i>Aythya ferina</i>	C	600-800i	C	ROSPA0054	Lacul Dunareni (Dunareni Lake)
A059	<i>Aythya ferina</i>	R	80-p	C	ROSPA0054	Lacul Dunareni (Dunareni Lake)
A061	<i>Aythya fuligula</i>	C	-	P	ROSPA0007	Balta Vederoasa
A061	<i>Aythya fuligula</i>	C	-	P	ROSPA0054	Lacul Dunareni (Dunareni Lake)
A060	<i>Aythya nyroca</i>	C	120-200i	R	ROSPA0007	Balta Vederoasa
A060	<i>Aythya nyroca</i>	R	23-45p	R	ROSPA0007	Balta Vederoasa
A060	<i>Aythya nyroca</i>	C	300-400i	R	ROSPA0012	Bratul Borcea (Borcea Arm)
A060	<i>Aythya nyroca</i>	R	100-120p	R	ROSPA0012	Bratul Borcea (Borcea Arm)
A060	<i>Aythya nyroca</i>	C	550-700i		ROSPA0054	Lacul Dunareni (Dunareni Lake)
A060	<i>Aythya nyroca</i>	R	54-75p		ROSPA0054	Lacul Dunareni (Dunareni Lake)

A021	<i>Botaurus stellaris</i>	W	2-5i	C	ROSPA0002	Allah Bair - Capidava
A396	<i>Branta ruficollis</i>	W	4500-7000i	P	ROSPA0012	Bratul Borcea (Borcea Arm)
A396	<i>Branta ruficollis</i>	W	120-120i	R	ROSPA0039	Dunare - Ostroave
A396	<i>Branta ruficollis</i>	C	400-500i	C	ROSPA0054	Lacul Dunareni (Dunareni Lake)
A396	<i>Branta ruficollis</i>	W	200-300i	C	ROSPA0054	Lacul Dunareni (Dunareni Lake)
A215	<i>Bubo bubo</i>	R	1-2p	C	ROSPA0001	Aliman - Adamclisi
A215	<i>Bubo bubo</i>	P	1-1p	C	ROSPA0002	Allah Bair - Capidava
A133	<i>Burhinus oedicephalus</i>	R	30-32p	R	ROSPA0001	Aliman - Adamclisi
A133	<i>Burhinus oedicephalus</i>	R	20-30p	R	ROSPA0002	Allah Bair - Capidava
A087	<i>Buteo buteo</i>	C	5000-10000i	C	ROSPA0002	Allah Bair - Capidava
A403	<i>Buteo rufinus</i>	R	12-14p	C	ROSPA0001	Aliman - Adamclisi
A403	<i>Buteo rufinus</i>	R	2-3p	C	ROSPA0002	Allah Bair - Capidava
A243	<i>Calandrella brachydactyla</i>	R	600-650p	R	ROSPA0001	Aliman - Adamclisi
A243	<i>Calandrella brachydactyla</i>	R	100-120p	C	ROSPA0002	Allah Bair - Capidava
A144	<i>Calidris alba</i>	C	-	R	ROSPA0054	Lacul Dunareni (Dunareni Lake)
A149	<i>Calidris alpina</i>	C	-	C	ROSPA0007	Balta Vederoasa
A149	<i>Calidris alpina</i>	C	-	C	ROSPA0054	Lacul Dunareni (Dunareni Lake)
A147	<i>Calidris ferruginea</i>	C	-	C	ROSPA0007	Balta Vederoasa
A147	<i>Calidris ferruginea</i>	C	-	C	ROSPA0054	Lacul Dunareni (Dunareni Lake)
A145	<i>Calidris minuta</i>	C	-	C	ROSPA0007	Balta Vederoasa
A145	<i>Calidris minuta</i>	C	-	C	ROSPA0054	Lacul Dunareni (Dunareni Lake)
A146	<i>Calidris temminckii</i>	C	-	R	ROSPA0054	Lacul Dunareni (Dunareni Lake)
A224	<i>Caprimulgus europaeus</i>	R	120-130p	P	ROSPA0001	Aliman - Adamclisi
A224	<i>Caprimulgus europaeus</i>	R	110-120p	C	ROSPA0002	Allah Bair - Capidava
A224	<i>Caprimulgus europaeus</i>	R	20-20p	R	ROSPA0039	Dunare - Ostroave

A366	<i>Carduelis cannabina</i>	C	-	C	ROSPA0002	Allah Bair - Capidava
A366	<i>Carduelis cannabina</i>	R	-	R	ROSPA0002	Allah Bair - Capidava
A366	<i>Carduelis cannabina</i>	C	-	C	ROSPA0007	Balta Vederoasa
A366	<i>Carduelis cannabina</i>	C	-	C	ROSPA0054	Lacul Dunareni (Dunareni Lake)
A364	<i>Carduelis carduelis</i>	C	-	C	ROSPA0002	Allah Bair - Capidava
A364	<i>Carduelis carduelis</i>	R	-	C	ROSPA0002	Allah Bair - Capidava
A364	<i>Carduelis carduelis</i>	C	-	C	ROSPA0007	Balta Vederoasa
A364	<i>Carduelis carduelis</i>	C	-	P	ROSPA0012	Bratul Borcea (Borcea Arm)
A364	<i>Carduelis carduelis</i>	P	-	C	ROSPA0012	Bratul Borcea (Borcea Arm)
A364	<i>Carduelis carduelis</i>	C	-	C	ROSPA0054	Lacul Dunareni (Dunareni Lake)
A363	<i>Carduelis chloris</i>	C	-	C	ROSPA0002	Allah Bair - Capidava
A363	<i>Carduelis chloris</i>	R	-	C	ROSPA0002	Allah Bair - Capidava
A363	<i>Carduelis chloris</i>	C	-	C	ROSPA0007	Balta Vederoasa
A363	<i>Carduelis chloris</i>	C	-	P	ROSPA0012	Bratul Borcea (Borcea Arm)
A363	<i>Carduelis chloris</i>	P	-	C	ROSPA0012	Bratul Borcea (Borcea Arm)
A363	<i>Carduelis chloris</i>	C	-	C	ROSPA0054	Lacul Dunareni (Dunareni Lake)
A365	<i>Carduelis spinus</i>	C	-	C	ROSPA0002	Allah Bair - Capidava
A288	<i>Cettia cetti</i>	R	-	R	ROSPA0007	Balta Vederoasa
A138	<i>Charadrius alexandrinus</i>	C	-	R	ROSPA0007	Balta Vederoasa
A138	<i>Charadrius alexandrinus</i>	C	44-77i	C	ROSPA0054	Lacul Dunareni (Dunareni Lake)
A138	<i>Charadrius alexandrinus</i>	R	12-14p	C	ROSPA0054	Lacul Dunareni (Dunareni Lake)
A136	<i>Charadrius dubius</i>	C	-	R	ROSPA0007	Balta Vederoasa
A136	<i>Charadrius dubius</i>	C	100-200i	C	ROSPA0054	Lacul Dunareni (Dunareni Lake)
A137	<i>Charadrius hiaticula</i>	C	-	R	ROSPA0007	Balta Vederoasa
A196	<i>Chlidonias hybridus</i>	C	2000-3000i	C	ROSPA0002	Allah Bair - Capidava

A196	<i>Chlidonias hybridus</i>	C	200-300i	R	ROSPA0007	Balta Vederoasa
A196	<i>Chlidonias hybridus</i>	C	400-600i	R	ROSPA0012	Bratul Borcea (Borcea Arm)
A196	<i>Chlidonias hybridus</i>	R	-	R	ROSPA0012	Bratul Borcea (Borcea Arm)
A196	<i>Chlidonias hybridus</i>	C	400-600i	R	ROSPA0039	Dunare - Ostroave
A196	<i>Chlidonias hybridus</i>	R	60-60p	R	ROSPA0039	Dunare - Ostroave
A196	<i>Chlidonias hybridus</i>	C	2000-i		ROSPA0054	Lacul Dunareni (Dunareni Lake)
A196	<i>Chlidonias hybridus</i>	R	300-400p		ROSPA0054	Lacul Dunareni (Dunareni Lake)
A198	<i>Chlidonias leucopterus</i>	C	-	R	ROSPA0007	Balta Vederoasa
A198	<i>Chlidonias leucopterus</i>	C	-	R	ROSPA0012	Bratul Borcea (Borcea Arm)
A198	<i>Chlidonias leucopterus</i>	C	-	R	ROSPA0054	Lacul Dunareni (Dunareni Lake)
A197	<i>Chlidonias niger</i>	C	400-600i	P	ROSPA0002	Allah Bair - Capidava
A197	<i>Chlidonias niger</i>	C	-	C	ROSPA0007	Balta Vederoasa
A197	<i>Chlidonias niger</i>	C	400-400i	C	ROSPA0012	Bratul Borcea (Borcea Arm)
A197	<i>Chlidonias niger</i>	C	400-400i	R	ROSPA0039	Dunare - Ostroave
A197	<i>Chlidonias niger</i>	C	200-i	C	ROSPA0054	Lacul Dunareni (Dunareni Lake)
A031	<i>Ciconia ciconia</i>	C	18000-50000i	C	ROSPA0002	Allah Bair - Capidava
A031	<i>Ciconia ciconia</i>	C	200-500i	C	ROSPA0007	Balta Vederoasa
A031	<i>Ciconia ciconia</i>	R	6-p	C	ROSPA0007	Balta Vederoasa
A031	<i>Ciconia ciconia</i>	C	4000-7000i	P	ROSPA0012	Bratul Borcea (Borcea Arm)
A031	<i>Ciconia ciconia</i>	R	64-77p	P	ROSPA0012	Bratul Borcea (Borcea Arm)
A031	<i>Ciconia ciconia</i>	C	1200-2400i	R	ROSPA0039	Dunare - Ostroave
A031	<i>Ciconia ciconia</i>	R	22-34p	R	ROSPA0039	Dunare - Ostroave
A031	<i>Ciconia ciconia</i>	C	200-500i	C	ROSPA0054	Lacul Dunareni (Dunareni Lake)
A031	<i>Ciconia ciconia</i>	R	8-p	C	ROSPA0054	Lacul Dunareni (Dunareni Lake)
A030	<i>Ciconia nigra</i>	C	1500-3000i	C	ROSPA0002	Allah Bair - Capidava

A030	<i>Ciconia nigra</i>	C	8-10i	C	ROSPA0007	Balta Vederoasa
A030	<i>Ciconia nigra</i>	C	200-500i	P	ROSPA0012	Bratul Borcea (Borcea Arm)
A030	<i>Ciconia nigra</i>	R	1-3p	P	ROSPA0012	Bratul Borcea (Borcea Arm)
A030	<i>Ciconia nigra</i>	R	4-4p	R	ROSPA0039	Dunare - Ostroave
A080	<i>Circaetus gallicus</i>	R	9-10p	P	ROSPA0001	Aliman - Adamclisi
A080	<i>Circaetus gallicus</i>	C	80-130i	R	ROSPA0002	Allah Bair - Capidava
A080	<i>Circaetus gallicus</i>	R	1-3p	R	ROSPA0002	Allah Bair - Capidava
A080	<i>Circaetus gallicus</i>	C	-	R	ROSPA0007	Balta Vederoasa
A080	<i>Circaetus gallicus</i>	C	-	R	ROSPA0054	Lacul Dunareni (Dunareni Lake)
A081	<i>Circus aeruginosus</i>	R	2-4i	C	ROSPA0001	Aliman - Adamclisi
A081	<i>Circus aeruginosus</i>	C	680-1780i	R	ROSPA0002	Allah Bair - Capidava
A081	<i>Circus aeruginosus</i>	R	2-8p	R	ROSPA0007	Balta Vederoasa
A081	<i>Circus aeruginosus</i>	R	14-24p	R	ROSPA0012	Bratul Borcea (Borcea Arm)
A081	<i>Circus aeruginosus</i>	R	14-20p	R	ROSPA0039	Dunare - Ostroave
A081	<i>Circus aeruginosus</i>	R	2-8p	R	ROSPA0054	Lacul Dunareni (Dunareni Lake)
A082	<i>Circus cyaneus</i>	C	80-100i	R	ROSPA0001	Aliman - Adamclisi
A082	<i>Circus cyaneus</i>	W	20-50i	R	ROSPA0001	Aliman - Adamclisi
A082	<i>Circus cyaneus</i>	C	40-82i	P	ROSPA0002	Allah Bair - Capidava
A082	<i>Circus cyaneus</i>	W	10-15i	P	ROSPA0002	Allah Bair - Capidava
A083	<i>Circus macrourus</i>	C	60-80i	P	ROSPA0001	Aliman - Adamclisi
A083	<i>Circus macrourus</i>	C	15-20i	C	ROSPA0002	Allah Bair - Capidava
A084	<i>Circus pygargus</i>	C	120-130i	R	ROSPA0001	Aliman - Adamclisi
A084	<i>Circus pygargus</i>	R	1-3p	R	ROSPA0001	Aliman - Adamclisi
A084	<i>Circus pygargus</i>	C	140-220i	R	ROSPA0002	Allah Bair - Capidava
A373	<i>Coccothraustes coccothraustes</i>	R	-	C	ROSPA0001	Aliman - Adamclisi

A373	<i>Coccythraustes coccythraustes</i>	R	-	C	ROSPA0012	Bratul Borcea (Borcea Arm)
A207	<i>Columba oenas</i>	R	-	C	ROSPA0001	Aliman - Adamclisi
A207	<i>Columba oenas</i>	R	-	C	ROSPA0002	Allah Bair - Capidava
A207	<i>Columba oenas</i>	C	-	C	ROSPA0012	Bratul Borcea (Borcea Arm)
A208	<i>Columba palumbus</i>	R	-	P	ROSPA0001	Aliman - Adamclisi
A208	<i>Columba palumbus</i>	C	-	C	ROSPA0002	Allah Bair - Capidava
A208	<i>Columba palumbus</i>	C	-	P	ROSPA0012	Bratul Borcea (Borcea Arm)
A208	<i>Columba palumbus</i>	R	-	C	ROSPA0012	Bratul Borcea (Borcea Arm)
A231	<i>Coracias garrulus</i>	R	100-120p	P	ROSPA0001	Aliman - Adamclisi
A231	<i>Coracias garrulus</i>	R	90-100p	C	ROSPA0002	Allah Bair - Capidava
A231	<i>Coracias garrulus</i>	R	70-80p	C	ROSPA0012	Bratul Borcea (Borcea Arm)
A231	<i>Coracias garrulus</i>	W	-	P	ROSPA0012	Bratul Borcea (Borcea Arm)
A231	<i>Coracias garrulus</i>	R	70-80p	R	ROSPA0039	Dunare - Ostroave
A113	<i>Coturnix coturnix</i>	R	600-p	C	ROSPA0001	Aliman - Adamclisi
A113	<i>Coturnix coturnix</i>	R	600-p	C	ROSPA0002	Allah Bair - Capidava
A212	<i>Cuculus canorus</i>	R	-	C	ROSPA0001	Aliman - Adamclisi
A212	<i>Cuculus canorus</i>	R	-	C	ROSPA0002	Allah Bair - Capidava
A212	<i>Cuculus canorus</i>	R	-	C	ROSPA0007	Balta Vederoasa
A212	<i>Cuculus canorus</i>	R	-	C	ROSPA0012	Bratul Borcea (Borcea Arm)
A212	<i>Cuculus canorus</i>	R	-	C	ROSPA0054	Lacul Dunareni (Dunareni Lake)
A036	<i>Cygnus olor</i>	C	200-i	C	ROSPA0007	Balta Vederoasa
A036	<i>Cygnus olor</i>	R	2-p	C	ROSPA0007	Balta Vederoasa
A036	<i>Cygnus olor</i>	C	200-i	C	ROSPA0054	Lacul Dunareni (Dunareni Lake)
A036	<i>Cygnus olor</i>	R	6-p	C	ROSPA0054	Lacul Dunareni (Dunareni Lake)
A036	<i>Cygnus olor</i>	W	120-i	C	ROSPA0054	Lacul Dunareni (Dunareni Lake)

A253	<i>Delichon urbica</i>	R	-	C	ROSPA0002	Allah Bair - Capidava
A253	<i>Delichon urbica</i>	C	-	C	ROSPA0007	Balta Vederoasa
A253	<i>Delichon urbica</i>	C	-	C	ROSPA0054	Lacul Dunareni (Dunareni Lake)
A238	<i>Dendrocopos medius</i>	R	20-22p	P	ROSPA0001	Aliman - Adamclisi
A238	<i>Dendrocopos medius</i>	R	15-18p	C	ROSPA0002	Allah Bair - Capidava
A429	<i>Dendrocopos syriacus</i>	R	30-40p	C	ROSPA0001	Aliman - Adamclisi
A429	<i>Dendrocopos syriacus</i>	R	15-20p	C	ROSPA0002	Allah Bair - Capidava
A236	<i>Dryocopus martius</i>	R	15-20p	C	ROSPA0002	Allah Bair - Capidava
A236	<i>Dryocopus martius</i>	P	-	R	ROSPA0012	Bratul Borcea (Borcea Arm)
A236	<i>Dryocopus martius</i>	R	10-10p	R	ROSPA0039	Dunare - Ostroave
A027	<i>Egretta alba</i>	R	34-39p	R	ROSPA0007	Balta Vederoasa
A027	<i>Egretta alba</i>	C	90-123i	C	ROSPA0054	Lacul Dunareni (Dunareni Lake)
A027	<i>Egretta alba</i>	W	11-i	C	ROSPA0054	Lacul Dunareni (Dunareni Lake)
A026	<i>Egretta garzetta</i>	R	300-320p	R	ROSPA0007	Balta Vederoasa
A026	<i>Egretta garzetta</i>	R	320-340p	R	ROSPA0012	Bratul Borcea (Borcea Arm)
A026	<i>Egretta garzetta</i>	R	320-320p	R	ROSPA0039	Dunare - Ostroave
A026	<i>Egretta garzetta</i>	C	400-500i	C	ROSPA0054	Lacul Dunareni (Dunareni Lake)
A026	<i>Egretta garzetta</i>	R	70-80p	C	ROSPA0054	Lacul Dunareni (Dunareni Lake)
A379	<i>Emberiza hortulana</i>	R	200-300p	C	ROSPA0001	Aliman - Adamclisi
A379	<i>Emberiza hortulana</i>	R	150-200p	C	ROSPA0002	Allah Bair - Capidava
A379	<i>Emberiza hortulana</i>	R	60-60p	R	ROSPA0039	Dunare - Ostroave
A269	<i>Erithacus rubecula</i>	C	-	C	ROSPA0007	Balta Vederoasa
A269	<i>Erithacus rubecula</i>	C	-	C	ROSPA0054	Lacul Dunareni (Dunareni Lake)
A511	<i>Falco cherrug</i>	R	1-p	P	ROSPA0001	Aliman - Adamclisi
A511	<i>Falco cherrug</i>	R	1-2p	P	ROSPA0002	Allah Bair - Capidava

A511	<i>Falco cherrug</i>	C	1-3i	P	ROSPA0039	Dunare - Ostroave
A103	<i>Falco peregrinus</i>	C	4-i	P	ROSPA0001	Aliman - Adamclisi
A099	<i>Falco subbuteo</i>	R	20-30p	C	ROSPA0012	Bratul Borcea (Borcea Arm)
A099	<i>Falco subbuteo</i>	R	20-20p	C	ROSPA0039	Dunare - Ostroave
A096	<i>Falco tinnunculus</i>	P	70-p	R	ROSPA0001	Aliman - Adamclisi
A096	<i>Falco tinnunculus</i>	P	20-40p	C	ROSPA0012	Bratul Borcea (Borcea Arm)
A096	<i>Falco tinnunculus</i>	P	50-50p	C	ROSPA0039	Dunare - Ostroave
A097	<i>Falco vespertinus</i>	C	200-400i	R	ROSPA0001	Aliman - Adamclisi
A097	<i>Falco vespertinus</i>	R	36-41p	R	ROSPA0001	Aliman - Adamclisi
A097	<i>Falco vespertinus</i>	R	14-22p	C	ROSPA0002	Allah Bair - Capidava
A097	<i>Falco vespertinus</i>	R	18-21p	R	ROSPA0012	Bratul Borcea (Borcea Arm)
A097	<i>Falco vespertinus</i>	R	18-21p	R	ROSPA0039	Dunare - Ostroave
A321	<i>Ficedula albicollis</i>	C	200-300i	P	ROSPA0001	Aliman - Adamclisi
A321	<i>Ficedula albicollis</i>	C	-	C	ROSPA0002	Allah Bair - Capidava
A320	<i>Ficedula parva</i>	C	800-1000i	P	ROSPA0001	Aliman - Adamclisi
A320	<i>Ficedula parva</i>	C	-	C	ROSPA0002	Allah Bair - Capidava
A359	<i>Fringilla coelebs</i>	C	-	C	ROSPA0007	Balta Vederoasa
A359	<i>Fringilla coelebs</i>	C	-	P	ROSPA0012	Bratul Borcea (Borcea Arm)
A359	<i>Fringilla coelebs</i>	P	-	C	ROSPA0012	Bratul Borcea (Borcea Arm)
A359	<i>Fringilla coelebs</i>	C	-	C	ROSPA0054	Lacul Dunareni (Dunareni Lake)
A244	<i>Galerida cristata</i>	R	300-320p	P	ROSPA0001	Aliman - Adamclisi
A244	<i>Galerida cristata</i>	R	120-140p	C	ROSPA0002	Allah Bair - Capidava
A153	<i>Gallinago gallinago</i>	C	-	C	ROSPA0007	Balta Vederoasa
A153	<i>Gallinago gallinago</i>	C	-	C	ROSPA0054	Lacul Dunareni (Dunareni Lake)
A135	<i>Glareola pratincola</i>	C	-	R	ROSPA0007	Balta Vederoasa

A135	<i>Glareola pratincola</i>	C	200-400i	P	ROSPA0054	Lacul Dunareni (Dunareni Lake)
A135	<i>Glareola pratincola</i>	R	20-40p	P	ROSPA0054	Lacul Dunareni (Dunareni Lake)
A075	<i>Haliaeetus albicilla</i>	C	4-6i	P	ROSPA0002	Allah Bair - Capidava
A075	<i>Haliaeetus albicilla</i>	R	-	P	ROSPA0002	Allah Bair - Capidava
A075	<i>Haliaeetus albicilla</i>	W	4-8i	P	ROSPA0002	Allah Bair - Capidava
A075	<i>Haliaeetus albicilla</i>	C	4-6i	R	ROSPA0007	Balta Vederoasa
A075	<i>Haliaeetus albicilla</i>	R	1-p	R	ROSPA0007	Balta Vederoasa
A075	<i>Haliaeetus albicilla</i>	C	17-17i	V	ROSPA0012	Bratul Borcea (Borcea Arm)
A075	<i>Haliaeetus albicilla</i>	R	1-2p	V	ROSPA0012	Bratul Borcea (Borcea Arm)
A075	<i>Haliaeetus albicilla</i>	C	17-17i	R	ROSPA0039	Dunare - Ostroave
A075	<i>Haliaeetus albicilla</i>	R	3-4p	R	ROSPA0039	Dunare - Ostroave
A075	<i>Haliaeetus albicilla</i>	C	4-6i	P	ROSPA0054	Lacul Dunareni (Dunareni Lake)
A092	<i>Hieraaetus pennatus</i>	C	15-20i	P	ROSPA0001	Aliman - Adamclisi
A092	<i>Hieraaetus pennatus</i>	R	3-4p	P	ROSPA0001	Aliman - Adamclisi
A092	<i>Hieraaetus pennatus</i>	C	40-90i	C	ROSPA0002	Allah Bair - Capidava
A131	<i>Himantopus himantopus</i>	C	40-50i	R	ROSPA0007	Balta Vederoasa
A131	<i>Himantopus himantopus</i>	R	2-7p	R	ROSPA0007	Balta Vederoasa
A131	<i>Himantopus himantopus</i>	C	200-500i	P	ROSPA0012	Bratul Borcea (Borcea Arm)
A131	<i>Himantopus himantopus</i>	R	-	P	ROSPA0012	Bratul Borcea (Borcea Arm)
A131	<i>Himantopus himantopus</i>	C	24-24i	R	ROSPA0039	Dunare - Ostroave
A131	<i>Himantopus himantopus</i>	C	120-135i	P	ROSPA0054	Lacul Dunareni (Dunareni Lake)
A131	<i>Himantopus himantopus</i>	R	16-20p	P	ROSPA0054	Lacul Dunareni (Dunareni Lake)
A299	<i>Hippolais icterina</i>	R	-	R	ROSPA0001	Aliman - Adamclisi
A299	<i>Hippolais icterina</i>	R	-	R	ROSPA0012	Bratul Borcea (Borcea Arm)
A251	<i>Hirundo rustica</i>	R	-	C	ROSPA0001	Aliman - Adamclisi

A251	<i>Hirundo rustica</i>	R	-	C	ROSPA0002	Allah Bair - Capidava
A251	<i>Hirundo rustica</i>	R	-	C	ROSPA0012	Bratul Borcea (Borcea Arm)
A022	<i>Ixobrychus minutus</i>	R	80-90p	R	ROSPA0007	Balta Vederoasa
A022	<i>Ixobrychus minutus</i>	R	40-50p	C	ROSPA0012	Bratul Borcea (Borcea Arm)
A022	<i>Ixobrychus minutus</i>	R	40-40p	R	ROSPA0039	Dunare - Ostroave
A022	<i>Ixobrychus minutus</i>	R	40-60p		ROSPA0054	Lacul Dunareni (Dunareni Lake)
A338	<i>Lanius collurio</i>	R	700-1000p	P	ROSPA0001	Aliman - Adamclisi
A338	<i>Lanius collurio</i>	R	1200-1300p	R	ROSPA0002	Allah Bair - Capidava
A338	<i>Lanius collurio</i>	R	-	C	ROSPA0012	Bratul Borcea (Borcea Arm)
A338	<i>Lanius collurio</i>	R	40-40p	R	ROSPA0039	Dunare - Ostroave
A340	<i>Lanius excubitor</i>	W	-	R	ROSPA0002	Allah Bair - Capidava
A339	<i>Lanius minor</i>	R	210-220p	P	ROSPA0001	Aliman - Adamclisi
A339	<i>Lanius minor</i>	R	120-130p	R	ROSPA0002	Allah Bair - Capidava
A339	<i>Lanius minor</i>	R	-	R	ROSPA0012	Bratul Borcea (Borcea Arm)
A339	<i>Lanius minor</i>	R	54-54p	R	ROSPA0039	Dunare - Ostroave
A341	<i>Lanius senator</i>	R	-	R	ROSPA0001	Aliman - Adamclisi
A459	<i>Larus cachinnans</i>	C	3000-5000i	C	ROSPA0002	Allah Bair - Capidava
A459	<i>Larus cachinnans</i>	C	-	C	ROSPA0007	Balta Vederoasa
A459	<i>Larus cachinnans</i>	C	-	C	ROSPA0012	Bratul Borcea (Borcea Arm)
A459	<i>Larus cachinnans</i>	C	-	C	ROSPA0054	Lacul Dunareni (Dunareni Lake)
A182	<i>Larus canus</i>	C	-	C	ROSPA0007	Balta Vederoasa
A182	<i>Larus canus</i>	C	-	C	ROSPA0054	Lacul Dunareni (Dunareni Lake)
A183	<i>Larus fuscus</i>	C	-	R	ROSPA0007	Balta Vederoasa
A183	<i>Larus fuscus</i>	C	-	R	ROSPA0054	Lacul Dunareni (Dunareni Lake)
A176	<i>Larus melanocephalus</i>	C	-	R	ROSPA0007	Balta Vederoasa

A176	<i>Larus melanocephalus</i>	C	400-600i	R	ROSPA0054	Lacul Dunareni (Dunareni Lake)
A177	<i>Larus minutus</i>	C	400-600i	C	ROSPA0002	Allah Bair - Capidava
A177	<i>Larus minutus</i>	C	120-230i	R	ROSPA0007	Balta Vederoasa
A177	<i>Larus minutus</i>	C	400-400i	V	ROSPA0012	Bratul Borcea (Borcea Arm)
A177	<i>Larus minutus</i>	C	400-400i	R	ROSPA0039	Dunare - Ostroave
A177	<i>Larus minutus</i>	C	400-800i	R	ROSPA0054	Lacul Dunareni (Dunareni Lake)
A179	<i>Larus ridibundus</i>	C	5000-10000i	C	ROSPA0002	Allah Bair - Capidava
A179	<i>Larus ridibundus</i>	C	-	C	ROSPA0007	Balta Vederoasa
A179	<i>Larus ridibundus</i>	C	-	P	ROSPA0012	Bratul Borcea (Borcea Arm)
A179	<i>Larus ridibundus</i>	C	10000-20000i	P	ROSPA0039	Dunare - Ostroave
A179	<i>Larus ridibundus</i>	C	12000-15000i	R	ROSPA0054	Lacul Dunareni (Dunareni Lake)
A150	<i>Limicola falcinellus</i>	C	-	R	ROSPA0054	Lacul Dunareni (Dunareni Lake)
A156	<i>Limosa limosa</i>	C	-	C	ROSPA0007	Balta Vederoasa
A156	<i>Limosa limosa</i>	C	-	C	ROSPA0054	Lacul Dunareni (Dunareni Lake)
A292	<i>Locustella luscinioides</i>	R	-	C	ROSPA0007	Balta Vederoasa
A292	<i>Locustella luscinioides</i>	R	-	C	ROSPA0012	Bratul Borcea (Borcea Arm)
A246	<i>Lullula arborea</i>	R	800-1000p	P	ROSPA0001	Aliman - Adamclisi
A246	<i>Lullula arborea</i>	R	120-150p	C	ROSPA0002	Allah Bair - Capidava
A271	<i>Luscinia megarhynchos</i>	R	-	C	ROSPA0001	Aliman - Adamclisi
A271	<i>Luscinia megarhynchos</i>	C	-	C	ROSPA0007	Balta Vederoasa
A271	<i>Luscinia megarhynchos</i>	C	-	C	ROSPA0012	Bratul Borcea (Borcea Arm)
A271	<i>Luscinia megarhynchos</i>	R	-	C	ROSPA0012	Bratul Borcea (Borcea Arm)
A271	<i>Luscinia megarhynchos</i>	C	-	C	ROSPA0054	Lacul Dunareni (Dunareni Lake)
A242	<i>Melanocorypha calandra</i>	R	2200-2500p	R	ROSPA0001	Aliman - Adamclisi
A242	<i>Melanocorypha calandra</i>	R	500-700p	R	ROSPA0002	Allah Bair - Capidava

A242	<i>Melanocorypha calandra</i>	W	200-400i	R	ROSPA0002	Allah Bair - Capidava
A230	<i>Merops apiaster</i>	R	-	C	ROSPA0001	Aliman - Adamclisi
A230	<i>Merops apiaster</i>	R	-	C	ROSPA0002	Allah Bair - Capidava
A230	<i>Merops apiaster</i>	R	120-120p	C	ROSPA0012	Bratul Borcea (Borcea Arm)
A230	<i>Merops apiaster</i>	R	120-120p	C	ROSPA0039	Dunare - Ostroave
A383	<i>Miliaria calandra</i>	R	-	P	ROSPA0001	Aliman - Adamclisi
A383	<i>Miliaria calandra</i>	R	-	C	ROSPA0002	Allah Bair - Capidava
A383	<i>Miliaria calandra</i>	C	-	C	ROSPA0007	Balta Vederoasa
A383	<i>Miliaria calandra</i>	C	-	C	ROSPA0012	Bratul Borcea (Borcea Arm)
A383	<i>Miliaria calandra</i>	P	-	P	ROSPA0012	Bratul Borcea (Borcea Arm)
A383	<i>Miliaria calandra</i>	C	-	C	ROSPA0054	Lacul Dunareni (Dunareni Lake)
A073	<i>Milvus migrans</i>	C	5-8i	C	ROSPA0001	Aliman - Adamclisi
A073	<i>Milvus migrans</i>	R	1-2i	C	ROSPA0001	Aliman - Adamclisi
A073	<i>Milvus migrans</i>	R	-1p	C	ROSPA0002	Allah Bair - Capidava
A073	<i>Milvus migrans</i>	R	3-4p	V	ROSPA0012	Bratul Borcea (Borcea Arm)
A073	<i>Milvus migrans</i>	R	3-4p	R	ROSPA0039	Dunare - Ostroave
A262	<i>Motacilla alba</i>	R	-	C	ROSPA0001	Aliman - Adamclisi
A262	<i>Motacilla alba</i>	R	-	C	ROSPA0002	Allah Bair - Capidava
A262	<i>Motacilla alba</i>	R	-	C	ROSPA0007	Balta Vederoasa
A262	<i>Motacilla alba</i>	R	-	C	ROSPA0012	Bratul Borcea (Borcea Arm)
A262	<i>Motacilla alba</i>	R	-	C	ROSPA0054	Lacul Dunareni (Dunareni Lake)
A260	<i>Motacilla flava</i>	R	-	P	ROSPA0001	Aliman - Adamclisi
A260	<i>Motacilla flava</i>	C	-	C	ROSPA0007	Balta Vederoasa
A260	<i>Motacilla flava</i>	R	-	C	ROSPA0007	Balta Vederoasa
A260	<i>Motacilla flava</i>	R	-	P	ROSPA0012	Bratul Borcea (Borcea Arm)

A260	<i>Motacilla flava</i>	C	-	C	ROSPA0054	Lacul Dunareni (Dunareni Lake)
A260	<i>Motacilla flava</i>	R	-	C	ROSPA0054	Lacul Dunareni (Dunareni Lake)
A319	<i>Muscicapa striata</i>	C	-	C	ROSPA0007	Balta Vederoasa
A319	<i>Muscicapa striata</i>	C	-	C	ROSPA0012	Bratul Borcea (Borcea Arm)
A319	<i>Muscicapa striata</i>	R	-	C	ROSPA0012	Bratul Borcea (Borcea Arm)
A319	<i>Muscicapa striata</i>	C	-	C	ROSPA0054	Lacul Dunareni (Dunareni Lake)
A058	<i>Netta rufina</i>	C	40-70i	C	ROSPA0054	Lacul Dunareni (Dunareni Lake)
A160	<i>Numenius arquata</i>	C	-	C	ROSPA0007	Balta Vederoasa
A160	<i>Numenius arquata</i>	C	-	C	ROSPA0054	Lacul Dunareni (Dunareni Lake)
A023	<i>Nycticorax nycticorax</i>	R	430-440p	R	ROSPA0007	Balta Vederoasa
A023	<i>Nycticorax nycticorax</i>	R	470-520p	R	ROSPA0012	Bratul Borcea (Borcea Arm)
A023	<i>Nycticorax nycticorax</i>	R	470-520p	R	ROSPA0039	Dunare - Ostroave
A023	<i>Nycticorax nycticorax</i>	C	120-400i		ROSPA0054	Lacul Dunareni (Dunareni Lake)
A435	<i>Oenanthe isabellina</i>	R	-	R	ROSPA0001	Aliman - Adamclisi
A277	<i>Oenanthe oenanthe</i>	R	-	C	ROSPA0001	Aliman - Adamclisi
A533	<i>Oenanthe pleschanka</i>	R	24-26p	R	ROSPA0001	Aliman - Adamclisi
A533	<i>Oenanthe pleschanka</i>	R	12-15p	C	ROSPA0002	Allah Bair - Capidava
A337	<i>Oriolus oriolus</i>	R	-	P	ROSPA0001	Aliman - Adamclisi
A337	<i>Oriolus oriolus</i>	C	-	C	ROSPA0007	Balta Vederoasa
A337	<i>Oriolus oriolus</i>	C	-	C	ROSPA0012	Bratul Borcea (Borcea Arm)
A337	<i>Oriolus oriolus</i>	R	-	C	ROSPA0012	Bratul Borcea (Borcea Arm)
A337	<i>Oriolus oriolus</i>	C	-	C	ROSPA0054	Lacul Dunareni (Dunareni Lake)
A214	<i>Otus scops</i>	R	-	C	ROSPA0001	Aliman - Adamclisi
A214	<i>Otus scops</i>	R	-	R	ROSPA0012	Bratul Borcea (Borcea Arm)
A094	<i>Pandion haliaetus</i>	C	-	R	ROSPA0007	Balta Vederoasa

A094	<i>Pandion haliaetus</i>	C	20-20i	R	ROSPA0039	Dunare - Ostroave
A094	<i>Pandion haliaetus</i>	C	-	R	ROSPA0054	Lacul Dunareni (Dunareni Lake)
A020	<i>Pelecanus crispus</i>	C	5-6i	R	ROSPA0007	Balta Vederoasa
A020	<i>Pelecanus crispus</i>	C	20-50i	P	ROSPA0039	Dunare - Ostroave
A020	<i>Pelecanus crispus</i>	C	41-50i		ROSPA0054	Lacul Dunareni (Dunareni Lake)
A020	<i>Pelecanus crispus</i>	W	4-i		ROSPA0054	Lacul Dunareni (Dunareni Lake)
A019	<i>Pelecanus onocrotalus</i>	C	300-600i	C	ROSPA0002	Allah Bair - Capidava
A019	<i>Pelecanus onocrotalus</i>	C	50-150i	C	ROSPA0012	Bratul Borcea (Borcea Arm)
A019	<i>Pelecanus onocrotalus</i>	C	50-150i	R	ROSPA0039	Dunare - Ostroave
A019	<i>Pelecanus onocrotalus</i>	C	120-160i	R	ROSPA0054	Lacul Dunareni (Dunareni Lake)
A072	<i>Pernis apivorus</i>	R	6-7p	P	ROSPA0001	Aliman - Adamclisi
A072	<i>Pernis apivorus</i>	C	340-775i	C	ROSPA0002	Allah Bair - Capidava
A017	<i>Phalacrocorax carbo</i>	C	-	C	ROSPA0007	Balta Vederoasa
A017	<i>Phalacrocorax carbo</i>	R	120-150p	C	ROSPA0007	Balta Vederoasa
A017	<i>Phalacrocorax carbo</i>	C	300-300i	R	ROSPA0012	Bratul Borcea (Borcea Arm)
A017	<i>Phalacrocorax carbo</i>	R	80-120p	R	ROSPA0012	Bratul Borcea (Borcea Arm)
A017	<i>Phalacrocorax carbo</i>	C	300-300i	R	ROSPA0039	Dunare - Ostroave
A017	<i>Phalacrocorax carbo</i>	R	80-120p	R	ROSPA0039	Dunare - Ostroave
A017	<i>Phalacrocorax carbo</i>	C	200-500i	C	ROSPA0054	Lacul Dunareni (Dunareni Lake)
A393	<i>Phalacrocorax pygmeus</i>	W	420-500i	R	ROSPA0002	Allah Bair - Capidava
A393	<i>Phalacrocorax pygmeus</i>	C	500-600i	R	ROSPA0007	Balta Vederoasa
A393	<i>Phalacrocorax pygmeus</i>	R	40-60p	R	ROSPA0007	Balta Vederoasa
A393	<i>Phalacrocorax pygmeus</i>	W	120-140i	R	ROSPA0007	Balta Vederoasa
A393	<i>Phalacrocorax pygmeus</i>	C	300-300i	P	ROSPA0012	Bratul Borcea (Borcea Arm)
A393	<i>Phalacrocorax pygmeus</i>	R	-	P	ROSPA0012	Bratul Borcea (Borcea Arm)

A393	<i>Phalacrocorax pygmeus</i>	W	240-240i	P	ROSPA0012	Bratul Borcea (Borcea Arm)
A393	<i>Phalacrocorax pygmeus</i>	C	300-300i	R	ROSPA0039	Dunare - Ostroave
A393	<i>Phalacrocorax pygmeus</i>	R	90-120p	R	ROSPA0039	Dunare - Ostroave
A393	<i>Phalacrocorax pygmeus</i>	W	240-240i	R	ROSPA0039	Dunare - Ostroave
A393	<i>Phalacrocorax pygmeus</i>	C	500-600i		ROSPA0054	Lacul Dunareni (Dunareni Lake)
A393	<i>Phalacrocorax pygmeus</i>	W	120-140i		ROSPA0054	Lacul Dunareni (Dunareni Lake)
A170	<i>Phalaropus lobatus</i>	C	-	R	ROSPA0007	Balta Vederoasa
A170	<i>Phalaropus lobatus</i>	C	-	R	ROSPA0054	Lacul Dunareni (Dunareni Lake)
A151	<i>Philomachus pugnax</i>	C	1200-1400i	R	ROSPA0054	Lacul Dunareni (Dunareni Lake)
A273	<i>Phoenicurus ochruros</i>	R	-	R	ROSPA0001	Aliman - Adamclisi
A273	<i>Phoenicurus ochruros</i>	C	-	C	ROSPA0007	Balta Vederoasa
A273	<i>Phoenicurus ochruros</i>	C	-	C	ROSPA0012	Bratul Borcea (Borcea Arm)
A273	<i>Phoenicurus ochruros</i>	C	-	C	ROSPA0054	Lacul Dunareni (Dunareni Lake)
A234	<i>Picus canus</i>	R	20-25p	P	ROSPA0001	Aliman - Adamclisi
A234	<i>Picus canus</i>	R	20-30p	R	ROSPA0002	Allah Bair - Capidava
A234	<i>Picus canus</i>	P	-	R	ROSPA0012	Bratul Borcea (Borcea Arm)
A234	<i>Picus canus</i>	R	30-30p	R	ROSPA0039	Dunare - Ostroave
A034	<i>Platalea leucorodia</i>	C	310-360i	C	ROSPA0007	Balta Vederoasa
A034	<i>Platalea leucorodia</i>	R	40-50p	C	ROSPA0007	Balta Vederoasa
A034	<i>Platalea leucorodia</i>	R	144-160p	C	ROSPA0012	Bratul Borcea (Borcea Arm)
A034	<i>Platalea leucorodia</i>	R	144-160p	R	ROSPA0039	Dunare - Ostroave
A034	<i>Platalea leucorodia</i>	C	310-360i		ROSPA0054	Lacul Dunareni (Dunareni Lake)
A032	<i>Plegadis falcinellus</i>	C	270-340i	P	ROSPA0007	Balta Vederoasa
A032	<i>Plegadis falcinellus</i>	R	22-30p	P	ROSPA0007	Balta Vederoasa
A032	<i>Plegadis falcinellus</i>	C	230-400i	R	ROSPA0012	Bratul Borcea (Borcea Arm)

A032	<i>Plegadis falcinellus</i>	R	120-130p	R	ROSPA0012	Bratul Borcea (Borcea Arm)
A032	<i>Plegadis falcinellus</i>	C	230-400i	R	ROSPA0039	Dunare - Ostroave
A032	<i>Plegadis falcinellus</i>	R	120-130p	R	ROSPA0039	Dunare - Ostroave
A032	<i>Plegadis falcinellus</i>	C	270-340i	R	ROSPA0054	Lacul Dunareni (Dunareni Lake)
A141	<i>Pluvialis squatarola</i>	C	-	C	ROSPA0054	Lacul Dunareni (Dunareni Lake)
A005	<i>Podiceps cristatus</i>	R	10-20p	C	ROSPA0007	Balta Vederoasa
A005	<i>Podiceps cristatus</i>	W	200-200i	C	ROSPA0012	Bratul Borcea (Borcea Arm)
A005	<i>Podiceps cristatus</i>	W	200-200i	R	ROSPA0039	Dunare - Ostroave
A005	<i>Podiceps cristatus</i>	R	40-50p	C	ROSPA0054	Lacul Dunareni (Dunareni Lake)
A006	<i>Podiceps grisegena</i>	C	-	R	ROSPA0007	Balta Vederoasa
A006	<i>Podiceps grisegena</i>	R	1-2p	C	ROSPA0007	Balta Vederoasa
A006	<i>Podiceps grisegena</i>	R	2-p	P	ROSPA0054	Lacul Dunareni (Dunareni Lake)
A008	<i>Podiceps nigricollis</i>	R	4-5p	R	ROSPA0007	Balta Vederoasa
A008	<i>Podiceps nigricollis</i>	R	8-10p	C	ROSPA0054	Lacul Dunareni (Dunareni Lake)
A120	<i>Porzana parva</i>	R	-	C	ROSPA0007	Balta Vederoasa
A120	<i>Porzana parva</i>	R	-	C	ROSPA0012	Bratul Borcea (Borcea Arm)
A120	<i>Porzana parva</i>	R	12-12p	R	ROSPA0039	Dunare - Ostroave
A132	<i>Recurvirostra avosetta</i>	C	20-30i	P	ROSPA0007	Balta Vederoasa
A132	<i>Recurvirostra avosetta</i>	R	3-5p	P	ROSPA0007	Balta Vederoasa
A132	<i>Recurvirostra avosetta</i>	C	200-500i	P	ROSPA0012	Bratul Borcea (Borcea Arm)
A132	<i>Recurvirostra avosetta</i>	R	-	P	ROSPA0012	Bratul Borcea (Borcea Arm)
A132	<i>Recurvirostra avosetta</i>	C	8-8i	R	ROSPA0039	Dunare - Ostroave
A132	<i>Recurvirostra avosetta</i>	C	90-123i	C	ROSPA0054	Lacul Dunareni (Dunareni Lake)
A132	<i>Recurvirostra avosetta</i>	R	15-18p	C	ROSPA0054	Lacul Dunareni (Dunareni Lake)
A336	<i>Remiz pendulinus</i>	R	-	C	ROSPA0007	Balta Vederoasa

A336	<i>Remiz pendulinus</i>	R	-	C	ROSPA0012	Bratul Borcea (Borcea Arm)
A249	<i>Riparia riparia</i>	R	-	C	ROSPA0001	Aliman - Adamclisi
A249	<i>Riparia riparia</i>	R	300-500p	C	ROSPA0002	Allah Bair - Capidava
A249	<i>Riparia riparia</i>	C	-	C	ROSPA0007	Balta Vederoasa
A249	<i>Riparia riparia</i>	R	-	C	ROSPA0007	Balta Vederoasa
A249	<i>Riparia riparia</i>	R	750-1100p	C	ROSPA0012	Bratul Borcea (Borcea Arm)
A249	<i>Riparia riparia</i>	R	750-1100p	C	ROSPA0039	Dunare - Ostroave
A249	<i>Riparia riparia</i>	C	-	C	ROSPA0054	Lacul Dunareni (Dunareni Lake)
A275	<i>Saxicola rubetra</i>	C	-	C	ROSPA0002	Allah Bair - Capidava
A275	<i>Saxicola rubetra</i>	C	-	C	ROSPA0007	Balta Vederoasa
A275	<i>Saxicola rubetra</i>	C	-	C	ROSPA0012	Bratul Borcea (Borcea Arm)
A275	<i>Saxicola rubetra</i>	C	-	C	ROSPA0054	Lacul Dunareni (Dunareni Lake)
A276	<i>Saxicola torquata</i>	R	-	C	ROSPA0001	Aliman - Adamclisi
A276	<i>Saxicola torquata</i>	R	-	C	ROSPA0002	Allah Bair - Capidava
A276	<i>Saxicola torquata</i>	C	-	C	ROSPA0007	Balta Vederoasa
A276	<i>Saxicola torquata</i>	C	-	C	ROSPA0054	Lacul Dunareni (Dunareni Lake)
A195	<i>Sterna albifrons</i>	C	-	R	ROSPA0007	Balta Vederoasa
A195	<i>Sterna albifrons</i>	C	400-400i	P	ROSPA0012	Bratul Borcea (Borcea Arm)
A195	<i>Sterna albifrons</i>	C	400-400i	R	ROSPA0039	Dunare - Ostroave
A195	<i>Sterna albifrons</i>	R	25-30p	R	ROSPA0039	Dunare - Ostroave
A195	<i>Sterna albifrons</i>	C	60-70i	C	ROSPA0054	Lacul Dunareni (Dunareni Lake)
A193	<i>Sterna hirundo</i>	C	2000-3000i	P	ROSPA0002	Allah Bair - Capidava
A193	<i>Sterna hirundo</i>	R	-	P	ROSPA0002	Allah Bair - Capidava
A193	<i>Sterna hirundo</i>	C	1000-1200i	P	ROSPA0007	Balta Vederoasa
A193	<i>Sterna hirundo</i>	C	1000-2000i	C	ROSPA0012	Bratul Borcea (Borcea Arm)

A193	<i>Sterna hirundo</i>	C	1000-2000i	R	ROSPA0039	Dunare Ostroave	-
A193	<i>Sterna hirundo</i>	C	1000-1200i	C	ROSPA0054	Lacul Dunareni (Dunareni Lake)	
A210	<i>Streptopelia turtur</i>	R	-	C	ROSPA0001	Aliman Adamclisi	-
A210	<i>Streptopelia turtur</i>	R	-	C	ROSPA0002	Allah Bair Capidava	-
A351	<i>Sturnus vulgaris</i>	C	-	C	ROSPA0002	Allah Bair Capidava	-
A351	<i>Sturnus vulgaris</i>	R	-	C	ROSPA0002	Allah Bair Capidava	-
A351	<i>Sturnus vulgaris</i>	C	-	C	ROSPA0007	Balta Vederoasa	
A351	<i>Sturnus vulgaris</i>	C	-	C	ROSPA0012	Bratul Borcea (Borcea Arm)	
A351	<i>Sturnus vulgaris</i>	P	-	C	ROSPA0012	Bratul Borcea (Borcea Arm)	
A351	<i>Sturnus vulgaris</i>	C	-	C	ROSPA0054	Lacul Dunareni (Dunareni Lake)	
A311	<i>Sylvia atricapilla</i>	R	-	C	ROSPA0001	Aliman Adamclisi	-
A311	<i>Sylvia atricapilla</i>	R	-	C	ROSPA0002	Allah Bair Capidava	-
A311	<i>Sylvia atricapilla</i>	R	-	C	ROSPA0012	Bratul Borcea (Borcea Arm)	
A310	<i>Sylvia borin</i>	R	-	C	ROSPA0001	Aliman Adamclisi	-
A310	<i>Sylvia borin</i>	R	-	C	ROSPA0002	Allah Bair Capidava	-
A310	<i>Sylvia borin</i>	R	-	C	ROSPA0012	Bratul Borcea (Borcea Arm)	
A309	<i>Sylvia communis</i>	R	-	C	ROSPA0001	Aliman Adamclisi	-
A309	<i>Sylvia communis</i>	R	-	C	ROSPA0002	Allah Bair Capidava	-
A309	<i>Sylvia communis</i>	R	-	C	ROSPA0012	Bratul Borcea (Borcea Arm)	
A307	<i>Sylvia nisoria</i>	R	200-300p	C	ROSPA0001	Aliman Adamclisi	-
A307	<i>Sylvia nisoria</i>	R	40-60p		ROSPA0002	Allah Bair Capidava	-
A307	<i>Sylvia nisoria</i>	C	-	R	ROSPA0007	Balta Vederoasa	
A307	<i>Sylvia nisoria</i>	R	-	R	ROSPA0012	Bratul Borcea (Borcea Arm)	
A307	<i>Sylvia nisoria</i>	R	-	R	ROSPA0039	Dunare Ostroave	-
A307	<i>Sylvia nisoria</i>	C	-	R	ROSPA0054	Lacul Dunareni (Dunareni Lake)	
A004	<i>Tachybaptus ruficollis</i>	R	10-20p	C	ROSPA0007	Balta Vederoasa	

A004	<i>Tachybaptus ruficollis</i>	R	30-40p	C	ROSPA0054	Lacul Dunareni (Dunareni Lake)
A397	<i>Tadorna ferruginea</i>	R	6-8p		ROSPA0002	Allah Bair - Capidava
A397	<i>Tadorna ferruginea</i>	C	10-20i	V	ROSPA0007	Balta Vederoasa
A397	<i>Tadorna ferruginea</i>	R	2-4p	V	ROSPA0007	Balta Vederoasa
A397	<i>Tadorna ferruginea</i>	C	22-31i		ROSPA0054	Lacul Dunareni (Dunareni Lake)
A397	<i>Tadorna ferruginea</i>	R	7-8p		ROSPA0054	Lacul Dunareni (Dunareni Lake)
A048	<i>Tadorna tadorna</i>	R	5-6p	C	ROSPA0007	Balta Vederoasa
A161	<i>Tringa erythropus</i>	C	-	C	ROSPA0007	Balta Vederoasa
A161	<i>Tringa erythropus</i>	C	-	C	ROSPA0054	Lacul Dunareni (Dunareni Lake)
A166	<i>Tringa glareola</i>	C	-	C	ROSPA0007	Balta Vederoasa
A166	<i>Tringa glareola</i>	C	800-1000i	P	ROSPA0012	Bratul Borcea (Borcea Arm)
A166	<i>Tringa glareola</i>	C	80-80i	R	ROSPA0039	Dunare - Ostroave
A166	<i>Tringa glareola</i>	C	-	C	ROSPA0054	Lacul Dunareni (Dunareni Lake)
A164	<i>Tringa nebularia</i>	C	-	R	ROSPA0007	Balta Vederoasa
A164	<i>Tringa nebularia</i>	C	-	C	ROSPA0054	Lacul Dunareni (Dunareni Lake)
A165	<i>Tringa ochropus</i>	C	-	C	ROSPA0007	Balta Vederoasa
A165	<i>Tringa ochropus</i>	C	-	C	ROSPA0054	Lacul Dunareni (Dunareni Lake)
A163	<i>Tringa stagnatilis</i>	C	-	R	ROSPA0007	Balta Vederoasa
A163	<i>Tringa stagnatilis</i>	C	-	C	ROSPA0054	Lacul Dunareni (Dunareni Lake)
A162	<i>Tringa totanus</i>	C	-	C	ROSPA0007	Balta Vederoasa
A162	<i>Tringa totanus</i>	C	-	C	ROSPA0054	Lacul Dunareni (Dunareni Lake)
A286	<i>Turdus iliacus</i>	C	-	R	ROSPA0002	Allah Bair - Capidava
A283	<i>Turdus merula</i>	C	-	C	ROSPA0002	Allah Bair - Capidava
A283	<i>Turdus merula</i>	C	-	C	ROSPA0007	Balta Vederoasa
A283	<i>Turdus merula</i>	C	-	C	ROSPA0054	Lacul Dunareni (Dunareni Lake)
A285	<i>Turdus philomelos</i>	C	-	C	ROSPA0002	Allah Bair - Capidava
A285	<i>Turdus philomelos</i>	C	-	C	ROSPA0007	Balta Vederoasa

A285	<i>Turdus philomelos</i>	C	-	C	ROSPA0012	Bratul Borcea (Borcea Arm)
A285	<i>Turdus philomelos</i>	C	-	C	ROSPA0054	Lacul Dunareni (Dunareni Lake)
A284	<i>Turdus pilaris</i>	C	-	C	ROSPA0002	Allah Bair - Capidava
A287	<i>Turdus viscivorus</i>	C	-	R	ROSPA0002	Allah Bair - Capidava
A232	<i>Upupa epops</i>	R	-	C	ROSPA0001	Aliman Adamclisi
A232	<i>Upupa epops</i>	R	-	C	ROSPA0002	Allah Bair - Capidava
A232	<i>Upupa epops</i>	C	-	C	ROSPA0007	Balta Vederoasa
A232	<i>Upupa epops</i>	R	-	C	ROSPA0012	Bratul Borcea (Borcea Arm)
A232	<i>Upupa epops</i>	C	-	C	ROSPA0054	Lacul Dunareni (Dunareni Lake)
A142	<i>Vanellus vanellus</i>	C	-	C	ROSPA0007	Balta Vederoasa
A142	<i>Vanellus vanellus</i>	R	40-50p	C	ROSPA0007	Balta Vederoasa
A142	<i>Vanellus vanellus</i>	C	2100-2500i	C	ROSPA0054	Lacul Dunareni (Dunareni Lake)
A142	<i>Vanellus vanellus</i>	R	40-50p	C	ROSPA0054	Lacul Dunareni (Dunareni Lake)

Legend

Site presence:

- P - there is at least one population with a permanent presence within the perimeter of the site
- R - there is at least one population present during the breeding period in the perimeter of the site
- C - concentration (the species is present during migration)
- W - wintering (the species is present during the winter)

Population:

- C - common
- R - rare
- V - very rare
- P - present

Annex 12 Spatial distribution of atmospheric concentrations of pollutants generated during the construction phase

Spatial distribution of atmospheric NO_x concentrations generated during the construction phase

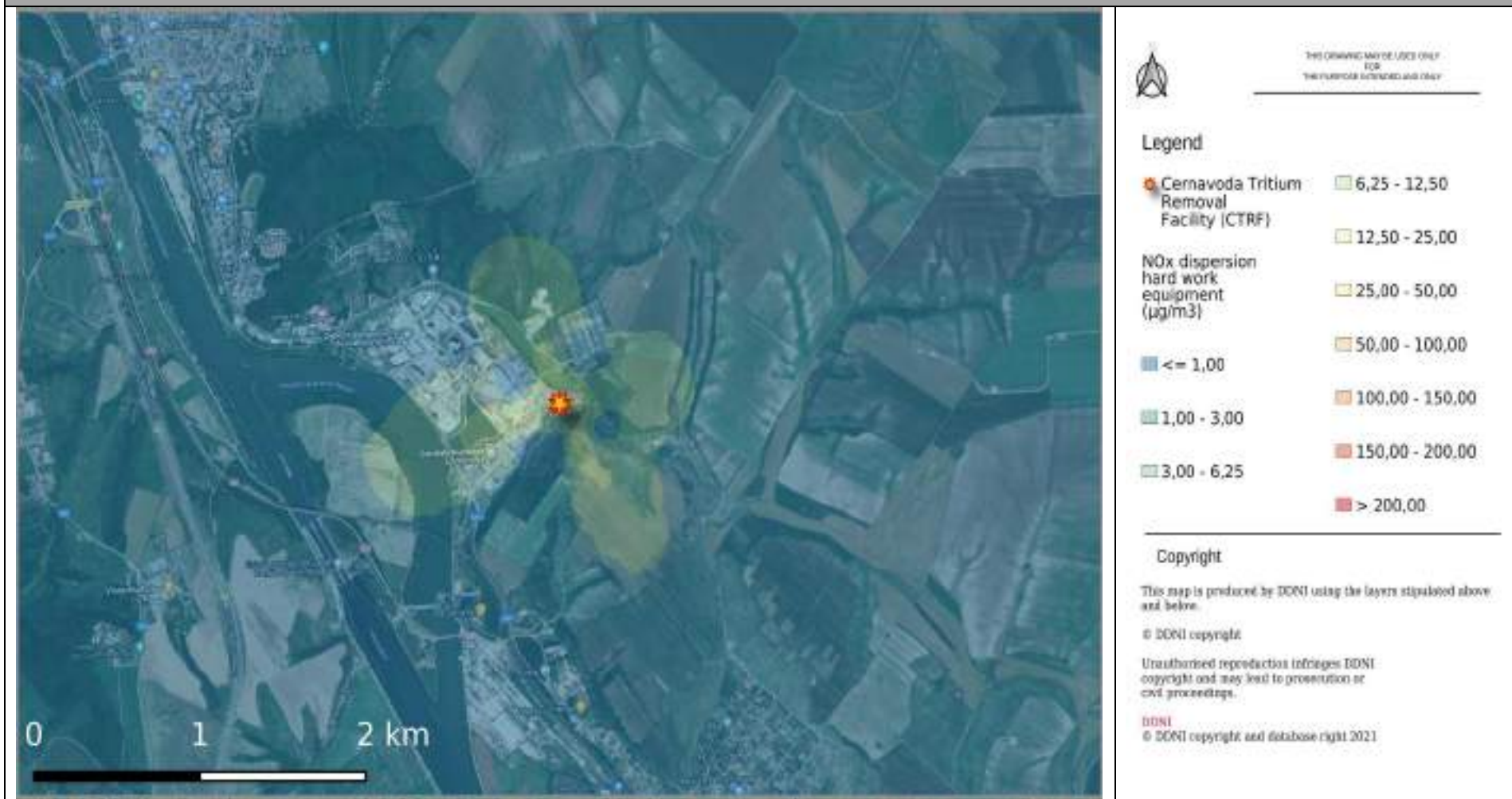

Spatial distribution of atmospheric concentrations of CO generated during the construction phase

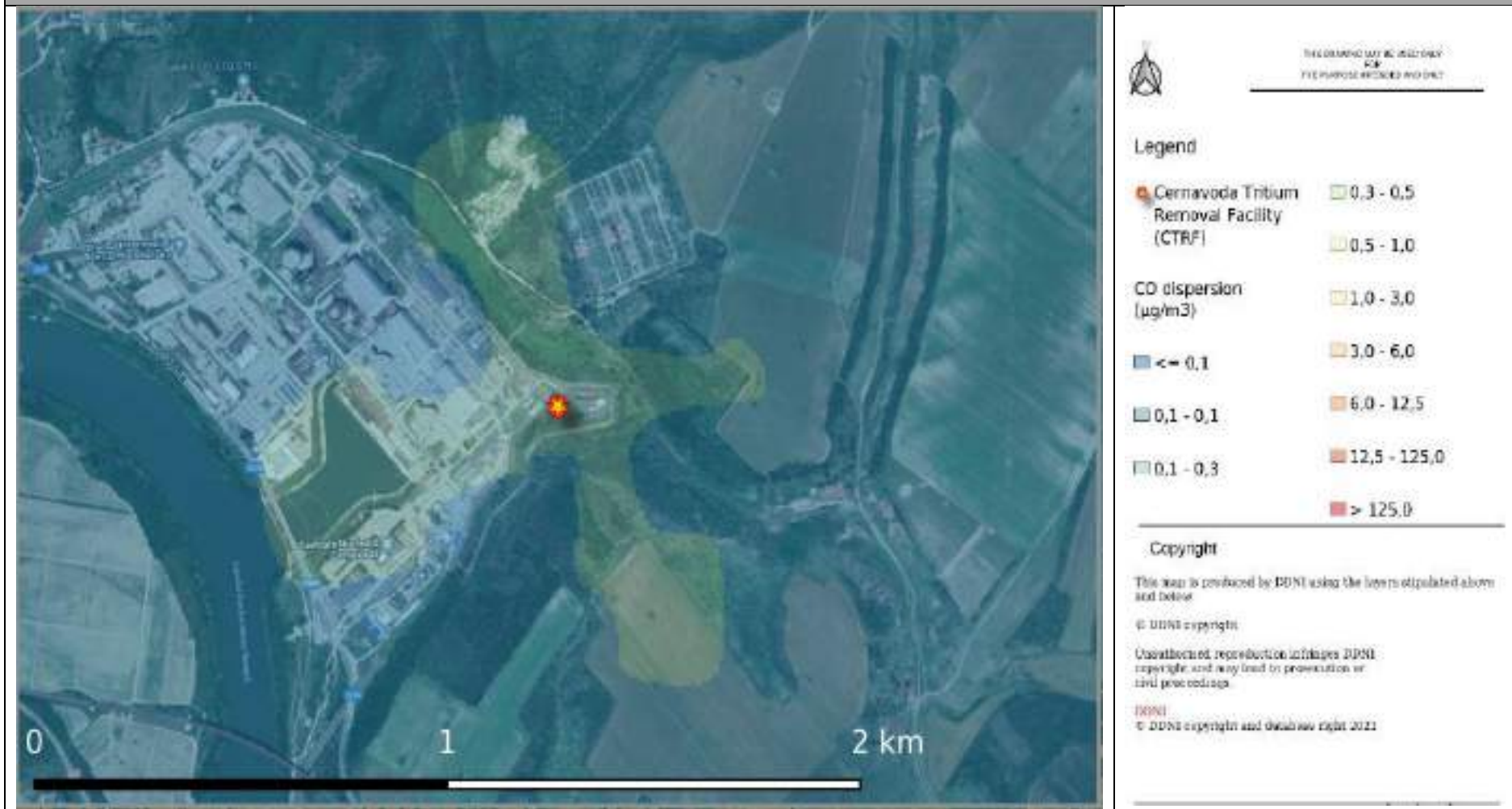

Spatial distribution of atmospheric concentrations of PM_{2.5} generated during the construction phase

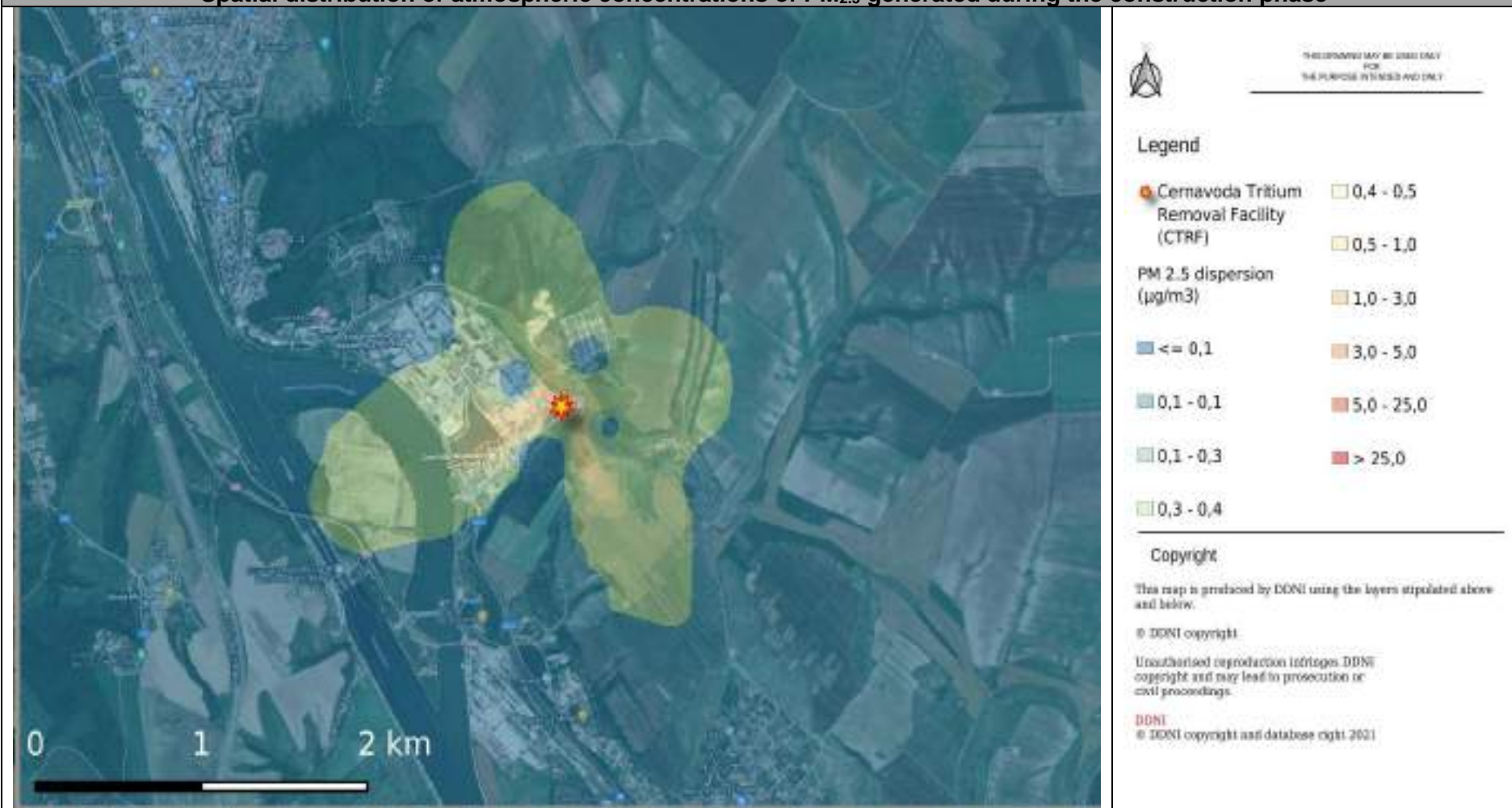

Spatial distribution of atmospheric concentrations of PM₁₀ generated during the construction phase



Annex 13 Spatial distribution of atmospheric concentrations of pollutants generated during operation



Spatial distribution of NO_x concentrations under simultaneous operation of the 2 diesel units - back-up generator



Spatial distribution of SO_x concentrations under diesel unit operation - back-up generator

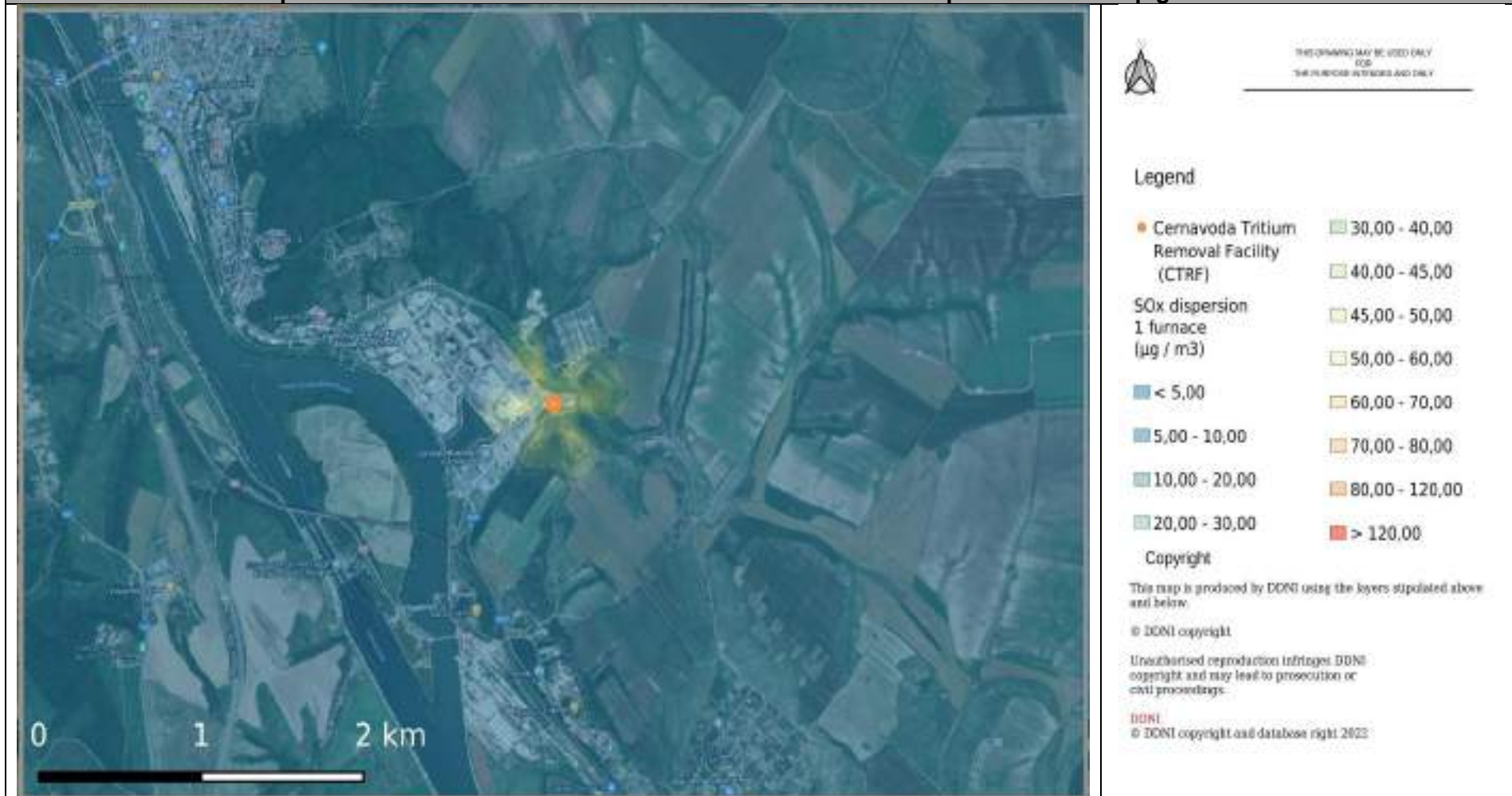

Spatial distribution of SOx concentrations under simultaneous operation of 2 diesel units - back-up generator



Spatial distribution of CO concentrations under diesel unit operation - back-up generator

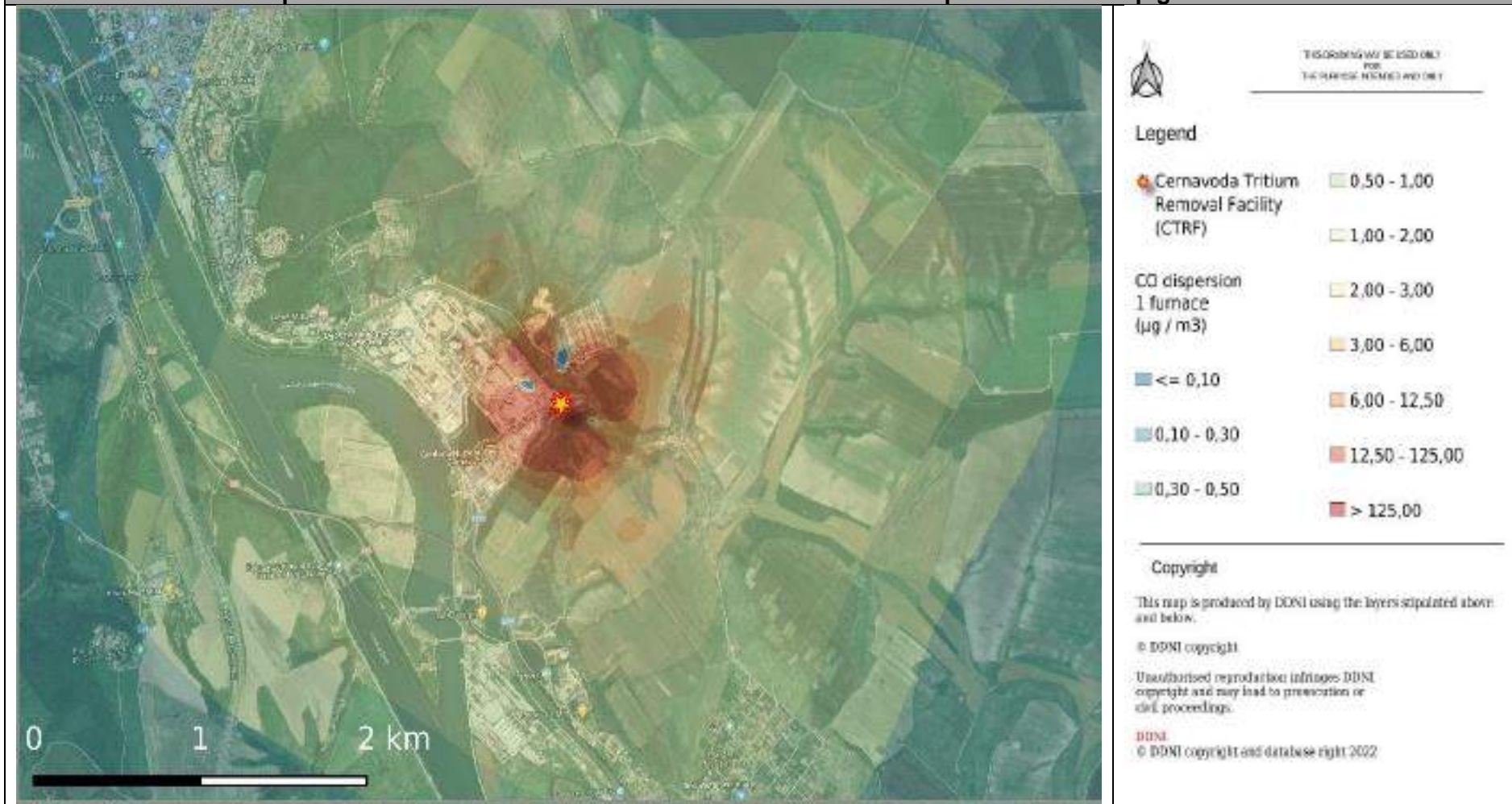

Spatial distribution of CO concentrations under simultaneous operation of the 2 diesel units - back-up generator



Spatial distribution of PM_{2.5} concentrations under one diesel back-up operation



Spatial distribution of PM_{2.5} concentrations under simultaneous operation of 2 diesel units - back-up generator



Spatial distribution of PM₁₀ concentrations under one diesel unit operation - back-up generator



Spatial distribution of PM₁₀ concentrations under simultaneous operation of the 2 diesel units - back-up generator



Annex 14 Spatial distribution of atmospheric concentrations of pollutants "all sources" at the NPP location

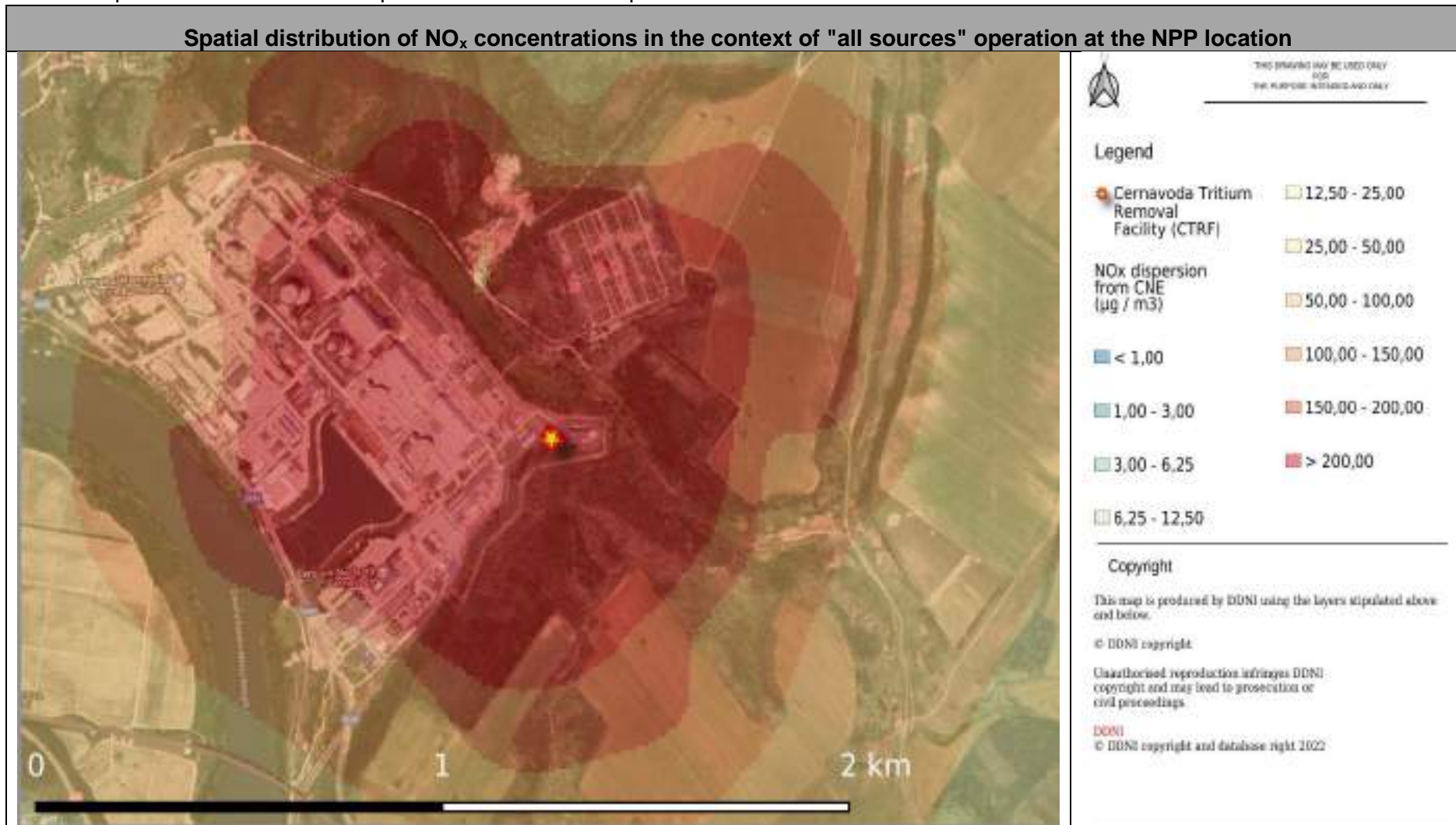

Spatial distribution of SO_x concentrations in the context of "all sources" operation at the NPP location

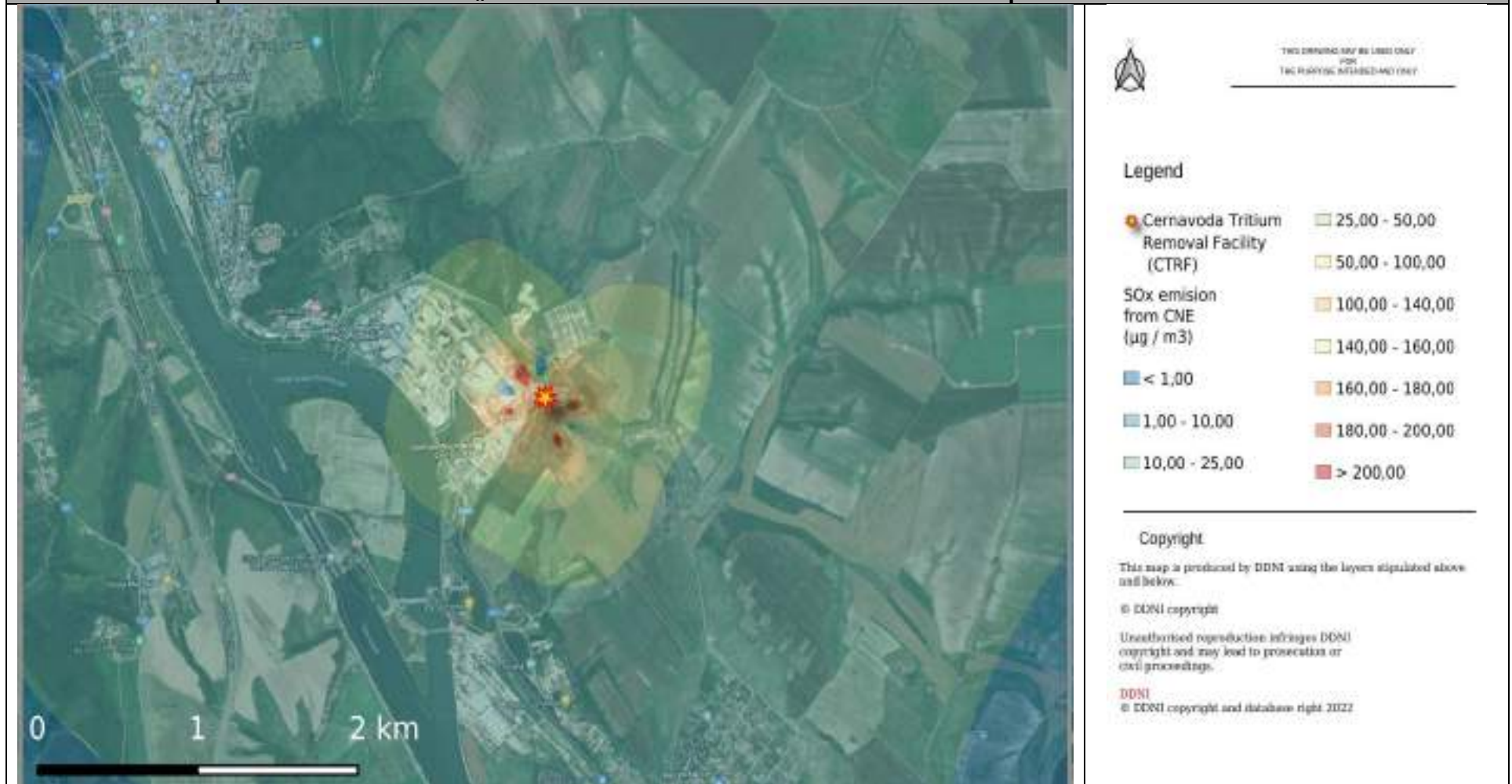

Spatial distribution of CO concentrations in the context of "all sources" operation at the NPP location



THIS DRAWING MAY BE USED ONLY FOR THE PURPOSE INTENDED AND ONLY

Legend

- Cernavoda Tritium Removal Facility (CTRF)
- 0,50 - 1,00
- 1,00 - 2,00
- 2,00 - 3,00
- 3,00 - 6,00
- 6,00 - 12,50
- 12,50 - 125,00
- > 125,00
- < 0,10
- 0,10 - 0,30
- 0,30 - 0,50

CO dispersion from CNE (µg / m³)

Copyright

This map is produced by DDNI using the layers stipulated above and below.

© DDNI copyright

Unauthorized reproduction infringes DDNI copyright and may lead to prosecution or civil proceedings.

DDNI
 © DDNI copyright and database right 2022



Spatial distribution of PM₁₀ concentrations in the context of "all sources" operation at the NPP location



Annex 15 Spatial distribution of atmospheric concentrations of pollutants in the context of "all sources" at the NPP and CTRF locations

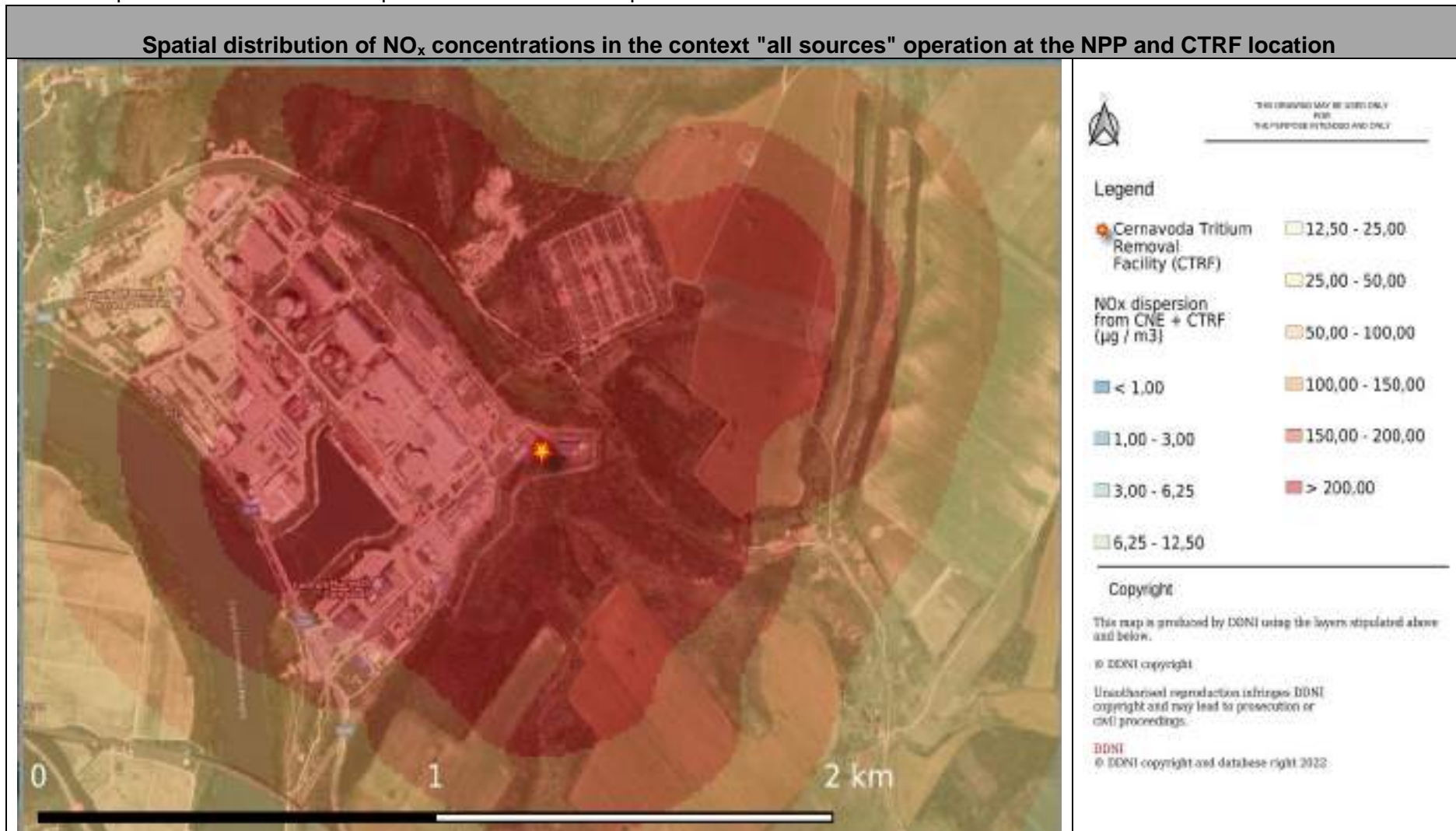

Spatial distribution of SO₂ concentrations in the context "all sources" operation at the NPP and CTRF location



Spatial distribution of CO₂ concentrations in the context "all sources" operation at the NPP and CTRF location



Spatial distribution of PM₁₀ concentrations in the context "all sources" operation at the NPP and CTRF location

